

POPULAR COMMUNICATIONS

New Cordless Phones Offer More Frequencies

Also in this issue:

- **The History Of Arizona's KOY**
- **DXing The Next Potential World Crisis**
- **All About Digital Broadcasting**
- **POP'COMM Reviews Probe Software**



U.S. \$3.50 Canada \$4.50



**Plus: Scanning, CB, Ham, Satellites,
Pirate Radio and More!**

AR3000A



The World At Your Fingertips



AOR, LTD.
2-6-4 Misuji, Taito-Ku,
Tokyo 111 Japan (c) 1995 AOR, LTD.
Licensed under US. Pat. 4,270,217

Specifications

Frequency Range	100kHz - 2036MHz* (Cell Blocked)
Frequency Readout	8 digit, 100Hz. Digital Display
Frequency Resolution	50Hz increments from 50Hz - 999.95kHz (All Modes)
Frequency Stability	+5 ppm from -10oC to +50oC
Antenna Impedance	50ohm
Receiving System	Triple Conversion (USB / LSB / CW / AM / NFM) Quadruple Conversion (WFM)
Selectivity	2.4kHz/ -6dB, 4.5kHz/ -60dB (USB / LSB / CW) 12 kHz/ -6dB, 15kHz/ -70dB (AM / NFM) 180kHz/ -6dB, 800kHz/ -50dB (WFM)

No other receiver on today's market offers so much... Wide frequency range, continuous coverage communication receiver with 400 channel memory, digital read-out and push-button control. Compact size 85cu. inch., 32oz. Low power consumption. 12VDC, 300mA. Bands covered are VHF Low Band, Aircraft, Marine, Business, FM Broadcast, Amateur Radio, Emergency Services, Government, and Television. Scanning, featuring full scan, programmed scan, mode selected scan, memory channel scan, auto write programmed scan, and priority scan. Allows external selection of frequency and mode by a serial data port for user friendly, computer interface. Also SDU5000 compatible.

Electronic Distributors

325 Mill St.

Vienna, VA. 22180

Ph: 703 938 8105

FAX: 703 938 4525

*Exclusive North & South
American Distributors*



CIRCLE 1 ON READER SERVICE CARD

EEB

NATIONS LARGEST RECEIVER OUTLET

SUMMER SUPER SALE!!!

AOR

AR2700 ¹⁻³	\$399.95
AR8000 ¹⁻³	\$599.95
AR3000A ¹⁻³	\$1029
SDU5000A/I	\$997.95

GRUNDIG

YB305	NEW	\$137.95
YB400	HOT	\$179.95
SAT700	Special	\$388.95

LOWE

HF150	Compact	\$579.95
HF225E	Europa	\$999.95

SANGEAN

ATS202	\$99.95
ATS606P w/Ant60	\$169.95
ATS808	\$137.95
ATS818	\$147.95

REALISTIC

PRO62	(CALL)	\$239.95
PRO2035	(CALL)	\$359.95

JOIN THE OPTO/AOR REVOLUTION!!!

• OPTO Electronics and AOR are revolutionizing the scanner world. The new Scout 40 version 3.1 and the AOR AR2700/AR8000 scanners gives you the intercept power in your hands, that just a few years ago could only be a dream. Imagine having your scanner hop on a signal the instant someone presses the mic button. The Scout will reaction tune your AOR scanner in a blink of an eye to any locally generated signal.

☛ **WHERE** is the Scout most effective? Sporting events, car races, air shows, NEWS gatherings, accident scenes, air ports, railroads, marinas, fast food drive-thrus, many more applications. Everywhere you turn today there's a walkie-talkie in use. Listen in, it's your world.

☛ **WHO** needs the Scout/AOR System? NEWS service, local TV/Radio stations, Police, DEA, Air ports, anyone that wants to know what is being transmitted in the immediate area, plus thousands of scanner listeners, FBI, Law enforcement, SWAT team, and surveillance.

☛ **WHAT** do you need? 1. Scout 40 version 3.1
2. AOR AR2700/AR8000 3. Input jack, modification to scanner
4. Interconnect cable. 5. Scout 40 v3.0 requires CB-AR cable \$49.00

EEB SPECIAL PACKAGE DEAL

- **AR2700**, Scout 40 version 3.1, Mod to AR2700, cable, (regular discount price \$899.90)...**Package Deal \$839.95**
- **AR8000**, Scout 40 version 3.1, Mod to AR8000, cable, (regular discount price \$1090)...**Package Deal \$1039.95**

EEB will install jack and wire in scanner, assure that your AOR warranty is good for one year and completely check out your system on our lab prior to shipping.

FREE with system purchase.

FREE AR2700/AR8000 Modification (\$50 value)

• AR2700	list \$499.95	EEB \$399.95
• AR8000	list \$799.95	EEB \$599.95
• MODS		EEB \$50.00
• Cable CB RT		EEB \$20.00
• SCOUT 40 v3.1 list	\$449.95	EEB \$419.95

SAVE up to \$300
OFF list price

**Bearcat SALE!!!**

BC3000XLT 25-550/760-1300MHz⁽¹⁾
• Scan 100ch/sec, search 300ch/sec, 400 memory channels, 20 x 20 banks.
LIST \$499.95 **EEB \$369.95**

BC9000XLT 25-550/760-1300MHz⁽¹⁾
• Alpha numeric LCD on all 500 memory ch. Scan 100 ch/sec, search 300 ch/sec, data skip, attenuator 15dB, COR recorder control.
LIST \$769.95 **EEB \$389.95**

BCT-7 All Band 26-956MHz⁽¹⁾
• A must for the frequent highway travelers. 7135 pre-programmed chs., search by state & service. Police, HP, DOT, Fire, News, WX, CB, plus 100 User memories, scan 100 ch/sec.
LIST \$319.95 **EEB \$169.95**

Other BEARCAT Scanners...

BC120XLT	\$129.95	BC760XLT ⁽¹⁻²⁾	\$199.95
SC150Y/B ⁽¹⁾	\$169.95	BC860XLT ⁽¹⁾	\$169.95
BC148XLT-1 ⁽¹⁾	\$99.95	BC890XLT ⁽¹⁻²⁾	\$229.95
BC220XLT ⁽¹⁾	\$224.95		

- (1) Cellular Block (not restorable)
- (2) Cellular Block, but can be restored
- (3) Un-Blocked O.K. to qualified buyers (Govt., Export, etc.)

☛ **Check out EEB's NEW BBS!!!**
Dial us up, Check us out!
Tech Info, Used-Demo Specials, MORE!
1 - 703 - 938 - 3781

Special SONY Summer SALE!!!**• ICFSW55 •**

"Among the best performers in compact portables, audio quality among the best, a superior performer in it's size class". (IBS Passport)

- 150kHz - 30MHz, 76 - 108MHz • AM, FM, CW, LSB, USB
- 125 station memory preset • Factory preset name tuning provides easy access to popular SWL stations • Direct keyboard entry • World clock rotary tuning dial for roaming the dial • Power 6VDC, or 4 AA (not incl.) AC adaptor is included.

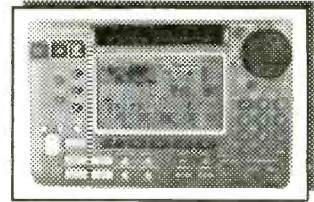

Limited Time... **\$319.95**
3 year Extended Warranty \$39.95

Other SONY's at Special Summer Prices

ICFSW7600G	\$179.95	• ICFSW100	\$344.95
ICFSW77	\$459.95	• ICFSW30	\$104.95
ICF2010	\$344.95	• ICFSW33	\$159.95

WJ HF1000 World's Ultimate Receiver

\$3799

Opt. Preselector
HF1000D \$649.00

**GE SUPERADIO II**

Puts the fun back into AM Radio!!!

Everyone needs a good AM/FM DX radio. Great audio, large ferrite antenna, 4 I.F. stages.



\$59.95

DRAKE R8A

Improved and upgraded version of the world famous R8.

- Improved Ergonomics
- Dynamic range (+100dB)
- 3rd OIP +20dBm
- Increase memory to 440 ch.
- Scan 40 ch/sec.



It's time to trade-in your R8, call for Quote.

R8A \$1085.00

95 Catalog... FREE
96 Pages, SWL, Scanners, Antennas, Books, Lots more.



FREE in the U.S., 3rd class 4 weeks • \$2 1st class (1 week), \$2 Can/Mex. \$5 elsewhere.

EEB

ELECTRONIC EQUIPMENT BANK
323 MILL Street NE
Vienna, VA 22180

*We accept VISA, MasterCard, American Express/Discover

ORDERS: 800-368-3270
Local Tech: 703-938-3350
FAX: 703-938-6911

*We ship via UPS, Federal Express and Mail

- Sorry, no COD's
- Free Catalog in USA
- Prices Subject to change
- Prices do not include freight
- Returns subject to restock fee up to 20%

We don't make
SCANNERS,
 We make them
 more *FUN* to use

Featuring The **OptoScan535:**
 Computer Controlled Scanning,
 Tone Decoding and Increased
 Scanning Speed for the Pro-2035



Introducing the OptoScan535, the next generation in computer controlled interface boards for the Radio Shack series of scanners. A Pro-2035 with an OptoScan535 is not only faster than an unmodified Pro-2035, it is faster than any other scanner using computer control. And that's just scratching the surface.

The OptoScan535 comes with two built-in CI-V interface converter jacks, eliminating the need for an external converter box. The OptoScan535 modification provides decoding on screen of CTCSS, DCS, and DTMF (Touch Tone®).

In addition to the speed and performance computer control offers, the OptoScan535 can also be used with the revolutionary Scout™. The Scout Reaction Tune™ feature allows the Scout to simultaneously tune the Pro-2035 through the CI-V port the OptoScan535 modification provides.

Features:

- Computer control of the Pro-2035
- Decodes CTCSS, DCS, and DTMF tones
- Two built-in CI-V data ports
- Use with the Scout™ for Reaction Tune™
- Supported by Probe, Scanstar, Scancat, ScannerWare for Windows, Radio Manager for Windows and WAVE for Mac
- Import files from PerCon FCC database
- Records frequencies into memory locations while unattended
- AM, FM-Narrowband and FM Wideband modes are supported
- Includes Hardware, Computer serial cable, and Demonstration software

*We don't make scanners,
 we make them more fun to use*



\$299

Scanner not included

CC50
 Deluxe Vinyl
 Opto Case.
 Holds Laptop,
 OS535
 &
 Accessories.
\$39



OPTOELECTRONICS® Order Line: (800) 327-5912

5821 NE 14th Avenue Fort Lauderdale, Florida 33334

Tel: (305) 771-2050

Fax: (305) 771-2052

Ask about our ScanBlaster Systems; including the Scout™, OptoScan456 or 535 and an array of accessories at great savings.

Contact Factory for shipping prices. Visa, Master Card, & C.O.D. (cash or money order only)

Made in the U.S.A

All prices and specifications are subject to change without notice or obligation.

CIRCLE 161 ON READER SERVICE CARD

AN EDITORIAL

Is There a Greater Hobby? Why Bother Looking?

I think the bug started to bite when I saved up enough pocket change as a kid, got driven to the local Sears store, and bought a cheap AM transistor radio that had the oddest battery ever. It was one of those batteries that were stocked only in odd shops that kept a box of them in a back room. But it became the radio under my pillow at night that not only introduced me to the rock 'n' roll that my parents didn't listen to, but also a whole new world.

As I lay awake on summer nights with my bright red radio neatly placed under my pillow, I slowly would move the tuning dial up and down the AM broadcast band. After I got over the novelty of the two rock 'n' roll stations in town—WFIL and WIBG (while avoiding Mom and Dad's WIP)—I wondered what else was out there in the ether. Could Philadelphia really have other radio stations to listen to? Soon, WABC from New York would find a place on my transistor's dial and I found myself listening to their countdown lists insofar as to actually write the station and request a copy of their annual playchart. And then something odd happened under that pillow. After my favorite baseball team wrapped up another game and the post-game show was over, I very carefully tuned that dial. And then the magic happened. "You're listening to Cardinals baseball on KMOX, St. Louis." Wow! My \$3.29 radio was pulling in a baseball game being transmitted from a half-continent away. There were Boston Red Sox games, as well as the Baltimore Orioles and Pittsburgh Pirates. My spare change let me eavesdrop on a nation—well, at least almost half of it.

My interest was further piqued in my childhood as my father became a volunteer firefighter and that brought all kinds of contraptions into the house. The devices ranged from the early alerting receivers with alarms that seemingly would rid the house of mosquitoes to the Hallicrafters S-95 that Dad dragged home from a fellow firefighter for \$25 one day. That old S-95 tuned all across the VHF high band, but Dad liked it set on 154.130 MHz, or there about on the old tunable dial, so we would know where the fires were as he raced off to siren blasts. I marveled at hearing a state communications center more than 100 miles away that had jurisdiction over a toll road. It would be only later on in my hobby that I would learn that the signal did not come from Harrisburg, Pa., but was relayed through microwave towers and retransmitted from a tower two blocks from our home. But it was fascinating!

Somewhere along the way, I received a

September is a Good Starting Point

In September of 1982, the first issue of *Popular Communications* rolled off the presses. I'm proud to say that I was the Editor of that issue, and the more than 150 that have followed. It's a dream come true, first having a hobby you love, then finding out it's possible to make that hobby the focal point of a lengthy and satisfying career. Yes, friends, my first article on hobby radio was published in *Popular Electronics* 40 years ago in 1955. Since 1960, I have always been lucky enough to be an editor of monthly magazines in the field of hobby communications, and found every minute an exciting challenge.

Now I'm coming up on my 63rd birthday. Mother Nature has spent several years giving me subtle and blunt hints that I might consider shedding the burdens, pressures, and stresses of being the person in charge of running a monthly magazine. Ten years ago, one of those hints was a heart attack. I promised myself and my family then that I would slow down. Now I suppose it's time to think about this.

As a result, I've decided to cut back on my daily workload. This will relieve me of having to deal with the unrelenting copy and other production deadline pressures that occur every week, month after month. These are only a few of the many high-pressure responsibilities and duties of a magazine editor.

Now, as Senior Editor I can continue

doing what I enjoy most, writing at a leisurely pace, providing occasional features, my monthly "Telephones Enroute" column, and other input for *Popular Communications*. Also, I hope to spend more time with my communications gear. I want to finally be able to have real vacations or even just *dolce far niente*. I want to spend some afternoons fishing with my grandsons without feeling guilty because I'm away from my desk.

At the helm of *Popular Communications* from now on will be the magazine's new Editor, Chuck Gysi, N2DUP. Chuck has been a valued and integral member of our editorial staff since 1983. He has written our scanner column as well as numerous features. Chuck is active on the Internet, and also has written for many hobby communications journals over the years through his activities in the communications hobby. Chuck has been my colleague and friend for many years, so I know how talented and innovative he is. I am very enthusiastic about Chuck's position as the new Editor of *POP'COMM*.

Therefore, September continues to be a special month for *Popular Communications*. A time for beginnings. Big things to come!

Tom Kneitel, K2AES
Senior Editor

pair of kiddie-talkies on CB Channel 11 for a Christmas gift and I was confused at hearing the constant mention of the word "breaker." I was convinced these seemingly distant radio operators could hear me talking with my sister and they were making a statement as if I were interfering with them—"breaking" up their conversations.

But it was in junior high school where the bug bit big time. One of my favorite activities was riding my bike downtown and walking through the old G.C. Murphy Co. store that anchored the shopping center. One day, my eyes caught sight of a Ross Electronics multiband portable radio. Yes, this radio not only had AM and this new-fangled FM that I kept hearing the kids talking about, but also a pair of shortwave bands, VHF high band, the VHF aero band, the VHF TV band—and get this...long-wave! I couldn't save my paper route mon-

ey fast enough. The \$39.99 that I needed to bring that radio home was my only focus.

And I did attain my goal. My ears were delighted in that now I not only could hear stations like KMOX, but also Radio Moscow. The BBC. Radio Sweden. Radio Canada International. Soon, I had 25 countries QSL'd. I was receiving gifts of books, magazines, diaries, newspapers and records from Radio Peking. Pennants came from Deutsche Welle. My parents' mailbox became a depository for mailing lists from places known as Radio Habana Cuba and Trans World Radio. My book reports in school focused on shortwave listeners' handbooks. And my social studies reports would quote Radio Moscow broadcasts.

It wasn't too much later when Dad was dragging me around to hamfests and CB-

(Continued on page 82)

GILFER KNOWS GRUNDIG!

GRUNDIG Yacht Boy 400



- 40 Memory Channels
- 1.6—30 MHz, plus LW, MW & FM Stereo (w/phones)
- Wide & Narrow Bandwidths
- SSB Capable
- Clock, Timer & Alarm Functions
- Carrying Case, External Antenna & Batteries Standard
- Optional AC Power Supply Available

GRUNDIG Satellit 700



- 512 Memory Channels (expandable to 2048!) with Alpha-numeric ID Display
- Synchronous AM Detection with Selectable Sideband
- 1.6—30 MHz, plus LW, MW & FM
- SSB Capable
- Clock, Timer & Alarm Functions
- AC Power Supply
- Audio Output: 3W

Send \$1 for complete catalog of shortwave products!

GILFER
SHORTWAVE

52 Park Avenue
Park Ridge, NJ 07656

ORDERS: (800) GILFER-1
NJ & Technical: (201) 391-7887
Fax: (201) 391-7433

MAILBAG

LETTERS TO THE EDITOR

Each month we select representative reader letters for our Mailbag column. We reserve the right to condense lengthy letters for space reasons. All letters submitted must be signed and show a return address. Upon request, we will withhold a sender's name if the letter is used in Mailbag. Address letters to: Chuck Gysi, N2DUP, Editor, Popular Communications, 76 N. Broadway, Hicksville NY 11801-2953, or send e-mail via the Internet to POPCOMM@aol.com.

Unformatted

Your March editorial on changing radio station formats expressed many of my concerns, however, I do not feel that there is much we can do about it. Corporations of people who buy radio stations are going to do pretty much what they want, despite any public outcry. I've worked in markets before where the station actually was making money, turning a profit and had good ratings, only to be swept out by some consultant or "programming guru." These people knew nothing about the community that their station was designed to serve. I've seen small 3,000-watt FM operations dump local news and sports and try to sound like some big-city jukebox. I've described some of these operations in a book I wrote about Chicago radio.

However, the biggest problem faced by those of us who wish to save a certain format are the stations that fire their staffs and hook up with a satellite service. The results are the following: little local programming; no time or temperature; cold, anonymous announcers making generic comments; off-air engineering instructions being heard by the listeners; and lots of dead air.

Your suggestion that we go to these stations and provide them with programming won't work because many have ripped out their turntables, cart machines, etc. In fact, they can't broadcast anything if they lose their satellite link.

John Russell Ghrist, N9HVF
Elgin, IL

Secret Listening

To the letter writer who can't believe that the friendly Third Reich would prohibit foreign broadcast listening: If he can get a photocopy of the user manual for a German radio such as a Philips WR-1 or V.E.F. KB-416, he can see for himself, assuming he can read German in the old obscure Fraktur typeface.

I packed away my manuals before I last moved, but here's the gist as I remember it: "According to Special Radio Broadcast Measures of 1939, listening to enemy

broadcast stations is prohibited and subject to strong punishment." The history books are replete with references to extralegal measures meted out to citizens of German-occupied countries who dared even to own a radio: burning of houses, deportation to prison camps and shootings.

H.E. Miller
Salt Lake City, UT

Allow me to help squash an attempt at revisionist history by one of your readers who tried to pass a 1939 news clipping saying that Nazis are warned to shun foreign radio as fiction.

I was 10 years old when World War II ended, and I remember very well that my father in occupied Belgium listened to the BBC, which we could get on medium wave, but had to hide doing it. I don't know what the imposed penalties were (probably some fines), but it was forbidden by the occupying forces.

Because our house was very large, the German army requisitioned part of it. The Germans used our garage for motorcycle repair and had us lodge a couple of soldiers during the war. Unlike the Gestapo or SS, the military treated the occupied population rather decently, in general. Despite their presence in the house, my father kept listening to the BBC.

Near the end of the war, they had to leave abruptly. A few years after the war, one of the soldiers visited us and a second one visited us several times. At the first visit, I remember my father telling the soldier that he listened to the BBC every day while they were inside our house, despite that it was strictly forbidden. I remember the German smiled and said that he knew all along, but did not care.

Guy R. Olbrechts
Bellevue, WA

Area Closes

James A. Williams' article on Area 51 near Las Vegas was certainly interesting. One of the best spots to overlook the area and to scan for the action, Freedom Ridge, recently has been declared off limits.

An article in the Las Vegas Sun contained information about the area being shut down. While it's not really communications related, it does represent one more way that Big Brother is trying to save us from ourselves.

I enjoy POP'COMM (and have for almost as many years as it's been around); I look forward to each new issue.

Richard Haskey
Operations Manager,
Western Wireless Works
Mesa, AZ



The Latest From AOR Products

Available at a Dealer Near You!



"The New Star" AR 2700...Out of this world Wideband Scanner

The new AR 2700 from AOR is another break-through for general coverage scanners at an affordable price. It combines wide freq. coverage with many advanced features & options, including computer interface and voice recorder. With this small marvel, you will never miss important calls and conversations through the use of the optional digital voice recorder.

• FEATURES •

Wide frequency range: 500kHz to 1,300MHz with various step size, 5, 6.25, 9, 10, 12.5, 20, 25, 30, 50, & 100kHz (wide FM only).

Auto Mode tuning: Comprehensive band plan has been pre-programmed to simplify the operation. The AR 2700 will automatically select the appropriate mode and channel step.

Great flexibility in programming, for Scan and Search mode. Delay, Pause and Priority intervals can be set to a specific value. Program search, Manual search, Bank link, Delay, Pause, Pass, Scan, Bank delete, Priority are provided.

High Capacity: 500 channels into 1- banks and 1- search banks.

Optional Digital Voice Recording: 20 seconds of digitized recorded conversation and playback through the use of the RU-2700 option.

Computer control port may be connected via an optional adaptor to a computer for remote control of the AR 2700.

AR8000 shocks the market. AOR made every effort to incorporate the latest technology in to this new scanner.

• SPECIFICATIONS •

- **Range:** .5 - 1900MHz usable to 100kHz
- **Modes:** AM/NFM/WFM/USB/LSB/CW
- **Stepsize:** 50Mz to 999.995kHz
- **Sensitivity(μV):** 30 to 1000MHz
SSB .2 AM 1.0 NFM .35 WFM 1.0
- **Filters:** (kHz) SSB 4 AM/NFM 12 WFM 180
- **Memories:** 50 ch. x 20 banks=1000 total
- **Size/Wt.:** 6.1 x 2.8 x 1.6 inch. 20 oz. batt. incl.

* Cell blocked for all, but Approved agencies.

• Covers .5-1900MHz*



- Ferrite Rod antenna below 2MHz
- Only portable scanner on U.S. market to have true SSB, both LSB & USB. Others attempt SSB using a BFO, but are difficult to tune and produce poor SSB audio.
- 4 level alpha numeric LCD read out frequency, mode, signal strength, band scope spectral display, battery low, remote and more

• Computer control up/down load data, will add a new dimension to the world of scanning.

• Clone your memory banks with a friend, load 1000 memory channels in seconds

.1 - 1900MHz*



WINDOWS Control of the AOR AR8000 Receiver

The Remote Computer Scanning System

Enhance the AR8000 receiver capabilities by providing automated Personal Computer control over the receiver scanning, logging and memory functions.



- △ Scan with user specified Tuning Step from 10Hz to 100MHz
- △ Scan by Mode, Class of Service, or Type of Unit
- △ Maximum Scan Rate possible. User adjustable if desired.
- △ Unattended frequency monitoring by time and date.
- △ Advanced computer control unlimited by the radio's memory capacity or predefined operations.
- △ Rearrange all your frequencies in any combination you desire by click and drag as well as direct entry.

Computer Interface for the AR8000



Unlike some of the European devices sold today, this unit is smaller, lighter, and makes no power demands on your receiver. With the extra shielding and smaller size there is less chance of additional interference leaking into your radio. The AR8000INF is also the only interface that is upgradeable for use with the optional Tape recorder controller due first quarter '95.

- △ Low Power, powered by your serial port
- △ No Drain on the batteries in the radio
- △ Light weight, perfect for Laptop use
- △ Hi-Tech Surface mount design for reliability
- △ 100% Shielded cable to receiver for reduced interference
- △ PC Software included for Windows and DOS
- △ Detailed Programers documentation available
- △ Designed and Manufactured in the USA

Other AOR Products available: SDU5000. AR3000. TSC100, WX2000



Electronic Distributors Co.

325 Mill Street, N.E.

Vienna, VA. 22180

Phone: 703 938 8105 FAX: 703 938 4525

Exclusive North and South American Distributors.



Cordless Phone Bonanza!

More Channels...More to Monitor?

BY HAROLD ORT, N2RLL

Take a look around you: It's a good bet your neighbor, co-worker, grocery store owner, electronic retailer, and nearly everyone else in your daily life uses a cordless phone. And no wonder. We're a perpetually busy society—one that can't be tied down by a 12-foot phone cord, not to mention it's also big business. According to the Electronic Industries Association, more than 16 million cordless phones were sold in 1994 to the tune of some \$1.1 billion. Today, at least 52 percent of U.S. homes have at least one of these phones.

Plenty to Hear

It's no wonder so many scanner users frequent these frequencies, with so many phones and so much to hear! Like what, you ask? Anything folks discuss on regular wired phones they also talk about on their cordless. It's sometimes humorous, sometimes romantic, but always downright interesting, to say the least. There have even been numerous cases of criminal activity being overheard and reported to the authorities by concerned scanner users. For

those who think we should mind our own business and let the police do their business, think about this: Wouldn't you be relieved to know that a scanner user just reported the fellow down the street for running a drug operation or other sleazy business from his basement? It makes our routine cordless conversations pale by comparison.

What's all the fuss about cordless phone monitoring? It's a simple question, but there is no simple answer. You'd think that cordless users, like cellular users, would realize there are no "strings" attached—after all, they're using a radio transmitter! But they don't. Most users think nothing of giving out credit card numbers, addresses, other phone numbers, bank account numbers, Social Security numbers, and tons of other personal information that should never be said aloud in public.

Ever hear your neighbors having a heated argument or candid discussion with their windows wide open within earshot of your open windows? When those neighbors use a cordless phone with a typical range of 1,500 feet, their conversations can be easily heard a mile or two away with little trou-

ble by a scanner enthusiast using a good outside antenna. Wouldn't you think they'd have the good sense to close the window or in the case of their cordless phone, either not use one or better yet, not divulge personal information?

And how many cordless users need that type of range? Very few, in fact. Most of us are simply interested in moving around the house or into the yard while chasing after the kids. So, if you don't need long cordless range and want to keep your conversations more private, why not consider the poor man's cordless range reducer by experimenting with operating your cordless with the base unit antenna collapsed? This drastically cuts down on the possibility of your calls being overheard. (And you thought we were just going to explain the ins and outs of snooping!)

900 MHz Technology

Then there's the new 900 MHz cordless phone technology that uses the 902-928 MHz part of the radio spectrum. In many cases, these cordless units are digi-



(Above) The Ramsey SS-70 Speech Scrambler also descrambles simple analog scrambled communications. It connects to the speaker output of your scanner.



(Right) Uniden's SCA 4500 Digital 25-channel cordless telephone answering system.

tal systems, which gives the user more security and limits interference. Some even use advanced spread spectrum circuitry that searches for the clearest, most secure channel—all in a tiny fraction of a second. According to the EIA, all digital 900 MHz phones are not necessarily spread spectrum. They advise consumers to ask questions and check the box!

According to a recent issue of *Countermeasures*, using an AOR AR1500 scanner, "general scanning in the operating range of the Escort 9000 (902 to 925 MHz) did not achieve any hits...the scanner did not stop on any active frequency in use by the Escort 9000." The article continues, "...when one of these (900 MHz) frequencies was manually tuned, an audible buzz was received...there was no audible voice at all." The *Countermeasures* folks have concluded that because of the widespread carrier of 900 MHz phones, they "are much more useful than their 46 MHz cousins." They also correctly report that it's possible to use the phone itself as a spread spectrum scanner, receiving signals from adjacent telephones! It would seem that if you're after the ultimate in cordless phone security, a 900 MHz spread spectrum phone is your best bet.

New Cordless Channels

Maybe it's hard to admit, but let's face it—we're a nation of snoops. What would you do, open or close your window to hear the next-door neighbors? The same holds true for cordless monitoring; for a growing number of scanner users, the temptation is just too strong to resist.

Cordless phone monitoring is growing by leaps and bounds. To make the listening even more interesting, the FCC recently added 15 new channel pairs to the existing 10 channels at 49 MHz in an effort to alleviate congestion on the existing channels. Uniden, a long-time manufacturer of scanners, CB radios and cordless phones recently introduced a line of 25-channel cordless models with suggested retail prices from \$109.95 to \$299.95. Some of Uniden's "high-security models equipped with Voice Scramble" include DX4519, 4534, and 3555. Their news release claims the new phones "effectively prevent the interception of private conversations by radio scanners or other cordless phones." They also have three completely digital cordless telephone answering systems.

Motorola's Secure Clear cordless phones are probably the most eavesdrop-proof cordless phones available. The use of security codes and their patented Secure Clear audio scrambling technology helps to prevent scanner monitoring. These cordless phones also are 25-channel models operating in the newly assigned frequency band. The feature works with 65,000 randomly selected codes.

Many of the new 25-channel phones, including those from Radio Shack and Mo-



Motorola's Secure Clear telephone uses audio scrambling technology that effectively prevents third-party monitoring.

torola, will have analog scramblers to keep ears tuned out. Analog scrambling, also known as speech inversion, has been around for years. It's a relatively simple scrambling

system used by some police and taxi dispatchers around the country. This process interchanges high and low speech frequencies by removing the carrier wave and trans-

Timestep

The Weather Satellite System

Images available as often as every 4 minutes.

Full screen color animation of up to 1000 frames.

Direct temperature readout.

Latitude / Longitude and political boundaries.

Easy to use mouse operation.

3D Cloud images.

Automatic operation.



HRPT Image of southern Hudson Bay

If you want to see the world's weather right now from anywhere in the world, including the Americas, Europe, the Middle East, Japan and Australia, then we have a system for you. Watch local weather systems or track hurricanes and tropical storms. We can supply simple systems for beginners or advanced HRPT systems for enthusiasts. All component parts are available separately. Systems and satellites available include HRPT, WEFAX, APT, NOAA, Meteor, Okean, GOES, Meteosat and GMS. Color brochures available.

Spectrum International Inc. PO Box 1084 Concord Mass. 01742 USA
Tel. (508) 263-2145 Fax. (508) 263-7008

Manufactured by: Timestep PO Box 2001 Newmarket CB8 8XB England
Tel. 01440 820040 Fax. 01440 820281

The Fastest OptoScan Software

- ✓ Easiest to Operate
- ✓ Most On-Screen Data
- ✓ Best Frequency Management
- ✓ Imports PerCon FCC Data
- ✓ Decodes CTCSS/DCS/DTMF
- ✓ Works on any DOS Computer

Check the rest, then BUY THE BEST!

\$99.95 + \$7.50 S/H
MasterCard/Visa/Check/Money Order

DataFile, Inc.
P.O. Box 20111
St. Louis, MO 63123 *Write for Free Details!*

**P
R
O
B
E**

YOU AIN'T HEARD NOTHIN' YET

Since 1967, CRB Research has been the world's leading publisher and supplier of unique hobby and professional books and information including:

- Scanner Frequency Guides
- Shortwave Frequency Guides
- Military/Federal
- & Other Related Topics!



CRB RESEARCH
P.O. Box 56, Commack, NY 11725
Phone: (516) 543-9169/FAX: (516) 543-7486

CIRCLE 11 ON READER SERVICE CARD

New Cordless Channels

Base	Handset
43.72	48.76
43.74	48.84
43.82	48.86
43.84	48.92
43.92	49.02
43.96	49.08
44.12	49.10
44.16	49.16
44.18	49.20
44.20	49.24
44.32	49.28
44.36	49.36
44.40	49.40
44.46	49.46
44.48	49.50

Original Cordless Channels

Base	Handset
46.61	49.67
46.63	49.845
46.67	49.86
46.71	49.77
46.73	49.875
46.77	49.83
46.83	49.89
46.87	49.93
46.93	49.99
46.97	49.97

BUY SMART

SG-230 Smartuner®

Antenna Coupler

SSB, AM, CW & DATA

You can't buy a smarter tuner than this. An automatic antenna coupler so intelligent it precisely tunes any length antenna -8 to 80 ft-in the HF band.

The Smartuner® automatically evaluates and switches 64 input and 32 output capacitance combinations, plus 256 inductance combinations in a "pi" network. The amazing result is over a half-million different ways to ensure a perfect match for your transceiver. And the most intelligent feature of all is that the Smartuner remembers the chosen frequency and tuning values, and will automatically reselect those values-in less than 10 ms, each time you transmit on that frequency.

The SG-230 Smartuner.® Buy smart.

WARRANTY REGISTRATION CARD
 NAME: J. MARTINO
 ADDRESS: SEE BELOW
 TELEPHONE: [blank]
 MODEL: SG-230
 PURCHASED FROM: SGC
 DATE PURCHASED: 1/11/89
 INSTALLED BY: J. MARTINO (OPERATOR)
 ONPE TRAINING DEPT. OF STATE WASHDC 20521

PERFORMANCE INFORMATION
 LENGTH OF TIME TO INSTALL: 5hrs (with COMPE STRIP)
 WAS SATISFACTORY TEST CALL MADE: YES
 DISTANCE COMMUNICATED: US/R/JAPAN/N.Z.
 INSTALLATION: [checked] OK [] DISCU [] POOR
 TUNING: [checked] Good [] Fair [] Poor
 TEST CALL: [checked] Good [] Fair [] Poor
 VOICE QUALITY: [checked] Good [] Fair [] Poor
 YOUR COMMENTS: WHAT CAN I SAY! BEST COUNTRY IN THE WORLD
 THX A LOT! E-S



SMARTUNER INSIDE

MICROPROCESSOR CONTROLLED • NON-VOLATILE MEMORY • WATERPROOF
 B.I.T.E. INDICATOR • 1.8 TO 30 MHZ RANGE
 3 TO 150 WATTS INPUT POWER • 10mS RETUNING TIME • 8 to 80 ft. ANTENNA (all types)



NO COMPROMISE COMMUNICATIONS
800-259-7331



SGC, INC. SGC BUILDING P.O. BOX 3526 BELLEVUE, WA 98009 TEL. (206) 746-6310 FAX: (206) 746-6384

CIRCLE 77 ON READER SERVICE CARD

mission of only one sideband in a communications link. This renders the speech unintelligible unless received by a device capable of replacing the carrier wave correctly. It's also easy to descramble.

Ramsey Electronics, 793 Canning Parkway, Victor, NY 14564 (phone 800-446-2295) makes a kit and wired analog descrambler that works just fine with any scanner. This small unit, the SS-70, connects to the speaker output terminal of your radio, has a single on/off switch and volume control. While it won't descramble digital scrambling, it will work with analog scrambled transmissions. Powered by an internal 9-volt battery, it also can be used with your telephone to effectively scramble your conversations. The cost of the kit is a mere \$39.95. Their fully assembled unit with case is only \$79.95. Tell Ramsey that *Popular Communications* sent you.

Some states have laws prohibiting deliberate monitoring of cordless calls. The Electronic Communications Privacy Act (ECPA) of 1986 is a federal law that previously covered only cellular phones, but was amended last year and now prohibits cordless monitoring, too. So *technically* you're not supposed to tune in your neighbor's private cordless phone conversations.

Our advice is to check your state and local laws first! If you get in the habit of listening to those private conversations near that open window, be prepared—you may hear things you weren't prepared for in the first place!

POP'COMM Review: DataFile's Probe

Scanning Software for the OptoScan456

If you own a Radio Shack Pro-2005/2006 scanner with the popular OptoScan456 computer interface from Optoelectronics, you should consider DataFile's Probe computer-aided scanning software. Exclusively designed for the OptoScan456, Probe utilizes a true database engine. Plus, Probe works with the popular PerCon FCC frequency databases.

Overview

Probe is designed specifically for use with the OptoScan456 computer interface installed in a Radio Shack Pro-2005/2006 scanner. Probe requires an IBM-compatible DOS-based (version 3.0 or higher) computer with at least 640K RAM, serial port and a hard drive. Although Probe runs well on computers with earlier processors such as the 8088 and 80286, the maximum scanning capability of 50 to 70 channels per second may require later processors such as 80386 or 80486. Probe uses a true database engine (dBASE format) allowing large capacity data management, while still attaining the maximum scanning performance from the OptoScan456. This

performance is achieved without the requirement of memory beyond the 640K level or very fast processors.

Some of Probe's powerful features include: Bank Management (selection of up to 99 banks to scan at one time with 1,000 frequencies in each bank), Group File Management (provides 4,000 groups of 99 banks, each with separate and customized configuration), Online Data for Active Frequencies (the scanning screen includes frequency, licensee name, address, city, state, county, radio service type and description, callsign, transmitter latitude and longitude), Powerful Frequency Management (the frequency file viewer/editor provides extensive versatility and control), "Lite Bar Tuning" (direct access "online tuning" from both the frequency and log file viewers with manual tuning capability), Online Status Indicators (status indicators and data include current active frequency, CTCSS/DCS/ DTMF codes, modulation, signal strength, log, record, alarm, delay, current time, and active log of the most recent frequency activity), Read and/or Squelch CTCSS and DCS Tone Codes (allows for identification, scan,

and optionally update frequency records with active analog or digital tone codes).

One of Probe's most powerful features is its ability to work with PerCon's FCC database on CD-ROM. Probe automatically will load and scan the station data provided by the PerCon database. Now you can scan all your favorite frequencies in your area without having to enter long frequency lists manually. It even will calculate the distance from your monitoring station to the transmitter by using latitude and longitude data. This is a most powerful and useful feature!

Summary

Probe's ease of use, powerful features and exceptional scanning speed make this a desirable software package for use with the OptoScan456. Through the use of "pipeline" tuning, maximum scanning speeds are attained for a given processor. The price of Probe Version 1.2 is \$99.95, plus shipping and handling. For more information, please contact DataFile, Inc., P.O. Box 20111, St. Louis, MO 63123, or send e-mail to DATAFILE@genie.com.

Reviewed by POP'COMM Staff

Frequency Data		Group/Log/Bank Data		Probe V1.0	
Status	ACTIVE	Group PerCon	10 Mile Radius	Log LOG.LGF	
MHz	0154.8450	Bank	34 POLICE		
CTCSS	103.5	Licensee Data			
Signal	- 62	Licensee	SAINT LOUIS, COUNTY OF		
Mode	NFM	Service	PP POLICE		
Priority	OFF	Address	7900 FORSYTH BLVD		
Alarm	0	City, St	CLAYTON	MO	
Log	YES	County	ST LOUIS		
Recorder	OFF	Callsign	KAA519	Distance	7.62
Active	00:00:02	Latitude	38 38 57	Longitude	090 20 20
Delay	00:03	DTMF Data			
Time	22:54:47	#95551212			
Latest Activity					
0463.1500	203.5	BRENTWOOD, CITY OF		L 22:54:39	1
0154.3100		MEHLVILLE F P D		L 22:54:16	1
0154.8150	103.5	FENTON, CITY OF		L 22:53:36	5
0154.8450	103.5	SAINT LOUIS, COUNTY OF		L 22:53:24	12
0155.6400		FRONTENAC, CITY OF		L 22:53:13	4
0155.5800	123.0	GLENDALE, CITY OF		L 22:53:07	3
0155.6400	241.8	FRONTENAC, CITY OF		L 22:52:54	6
0453.8000	146.2	ARNOLD, CITY OF		L 22:51:52	8
0042.3800	186.2	MISSOURI, STATE OF		L 22:51:46	2
[B]lanks [F]reqs [E]dit [R]ecord [V]iewlog [K]illtemp [S]ettings [M]anual					
[L]lockout [T]emplock [o]G] <Escape> = quit <Enter> = hold <Space> = next					

Another Mid-East Powder Keg

DXing the Next Potential World Crisis

BY GERRY L. DEXTER

Iraq was invaded a few months ago. Maybe you missed the networks' "extensive" TV coverage of Turkey's move into the Kurdish zone in northern Iraq. As this is written, Turkish troops still occupy a strip along the Iraq-Turkish border.

The invasion was designed to eliminate pockets of terrorists operating on behalf of the PKK—the Turkish Workers Party, which has been responsible for a long string of strikes inside Turkey.

The PKK is just one of Turkey's many problems—count the rising power of Islamic fundamentalism, a monster inflation rate, a contracting national output, a non-stop flow of Kurdish refugees and a weak,

uncertain government, and you have the reasons why some experts are calling Turkey "the sick man of Europe."

Turkey exists in a volatile area, nearly surrounded by nations suffering big problems, over and above the fact that many of these governments and peoples do not like each other. Rather than serving as an anchor helping to keep the area more or less stable, just the opposite is happening. Experts say the ingredients exist for an international crisis that could erupt sometime in the future if the government cannot get its act together. With the above as a preface, let's take a shortwave tour of the area and find out what we can hear.

The Kurds

The Kurds are spread through Iraq, Iran, Syria and Turkey, with those in Iraq living in a protected zone, supposedly safe from the clutches of Saddam. Many want a separate Kurdish state but others just seek more autonomy within whatever country they're living. There's a dictionary full of Kurdish political parties, many of which go after each other as much as they do non-Kurdish governments and populations.

There is no such thing as a "Kurdish state radio," but a number of Kurdish clandestine stations speak on behalf of various political parties, as well as air broadcasts sponsored by the Iranian and Iraqi gov-

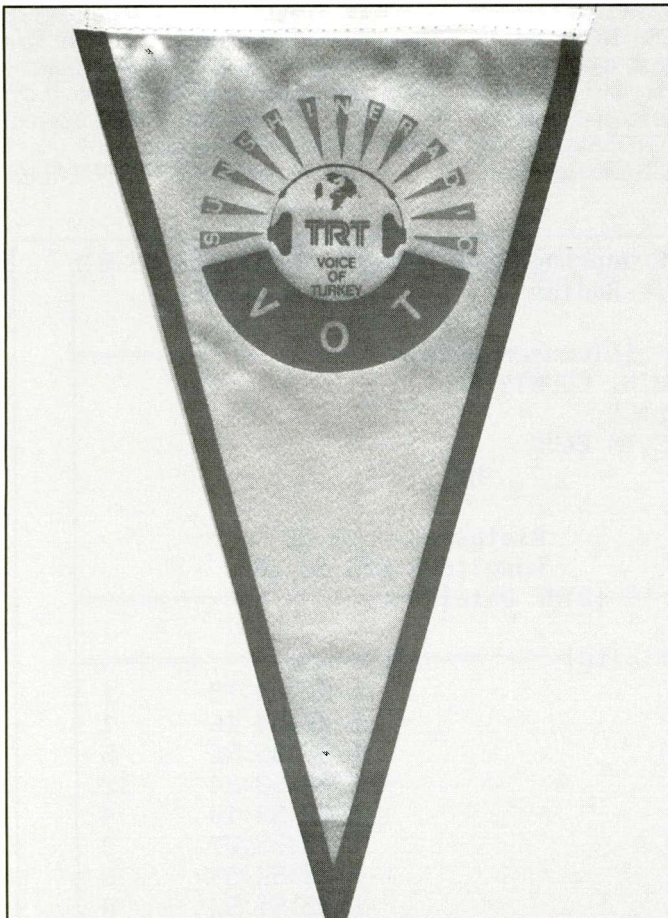

Pennants usually are in store for listeners who send reception reports to the Voice of Turkey.

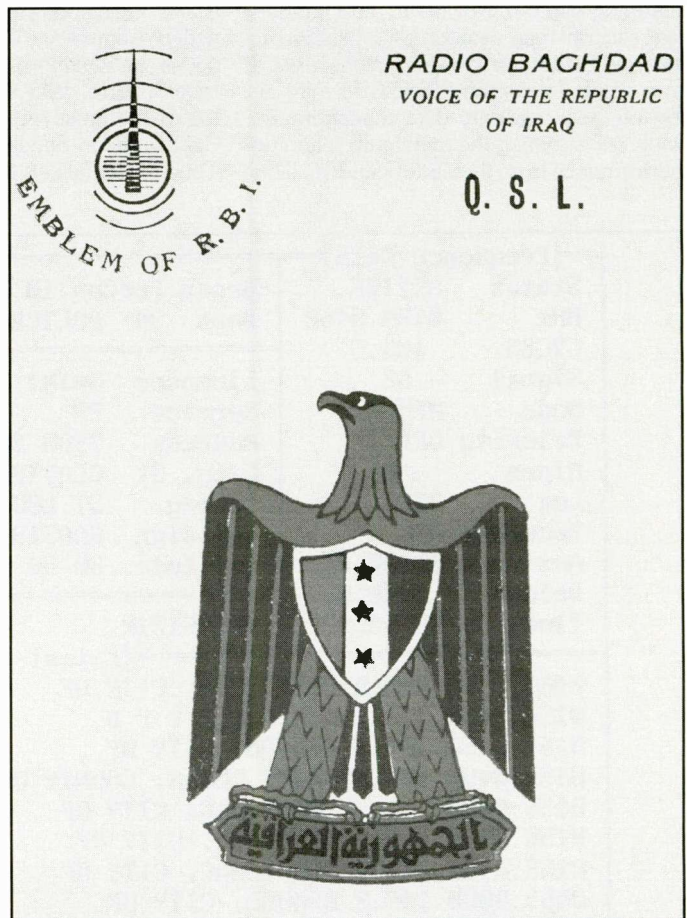

Radio Baghdad QSLs are not easily obtained these days.

Stop! Look! Listen!

We carry full lines of your favorite brands plus accessories, books and more!



AOR AR2700 Wide-Band Radio Receiver \$399

What an amazing breakthrough in value for under \$400!! This full featured unit combines the important features of wide band coverage, auto-mode bandplan data (with override), fast scan/search rates & ease of operation with the latest innovations of optional computer control, and clone of data. There is even an option available that records 20 seconds of audio directly off the air for playback! This receiver covers the frequency range from 500 kHz to 1300 MHz* and gives you 500 channels to put those frequencies in! Features: Auto-Mode tuning, AM, NFM & WFM, Optional voice recording, computer control, and data clone between sets.

Optoelectronics Scout 40 Frequency Scout \$439 OPTOELECTRONICS

The Scout 40 can record and store into memory 400 unique frequencies within a 10 MHz to 1.4 GHz range, while being able to record up to 255 hits on each channel in memory! Digital Filter/Auto Capture allows the Scout to record frequencies automatically! This unit will even automatically Reaction Tune or Memory Tune many receivers (call for more information). Features 10 digit LCD, EL backlight, and 16 segment signal strength bargraph. NiCad batteries, AC adapter/charger and PC utility disk are included.

Nevada SE 1300 VHF/UHF Discone Antenna \$89

If you've been looking for a superior wide band omni-directional antenna covering 25 to 1300 MHz, this is it! The SE 1300 is the ultimate wideband omni-directional antenna for hours of listening pleasure. Not only is it a receiving antenna, but it can also transmit on 50 MHz, 144 MHz, 430 MHz, 900 MHz and 1200 MHz with a maximum power rating of 200 watts. The antenna has stainless steel construction and comes complete with low-loss "N" connector, mounting kit and short mast section. The SE 1300 is excellent for indoor installation since it's only 5' 6" and weighs just 2.2 lbs, yet its construction and weather protected feedpoint beg to be out in the elements. This antenna is a must if you want the best possible results! Also available as Diamond D-130 w/PL-259 connector...\$99

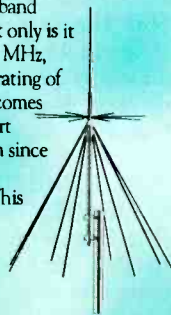

Sony ICF-SW100S World Band Receiver \$349

- Ultimate Travel Radio...smallest radio available that features synchronous detection
- Outstanding Performance...covers 150 kHz to 30 MHz continuously as well as AM broadcast and FM stereo

Economy Service available on most orders only \$6.95 **FedEx** Federal Express



Bearcat BC9000XLT Continuous Band Scanner \$399

The Bearcat BC9000XLT is a 500 channel, high performance continuous band scanner. Features: 25 MHz to 1.3 GHz, V.F.O. Control, selectable attenuator, selectable mode, selectable delay, TurboScan™ & Search, LCD dot matrix, alpha display, frequency transfer, automatic store, aux. line output, data skip feature, & programmable search.



JIM M75 GaAs FET VHF/UHF Scanner Pre-Amp \$99

State of the art surface-mount technology coupled with features not found on other pre-amps makes the M75 simply the best. Wide band (24 to 2150 MHz), variable gain -10 dB (attenuation) to +20 dB gain. Bandwidth selector switch covers 3 bands: a) 225 to 1500 MHz-reduces TV, FM and Hi Power VHF pagers for clear UHF Airband, PSB, Cellular etc.; b) 108 to 185 MHz-for optimum reception of VHF Airband, 2m Amateur Radio, and other VHF communication eliminating VHF TV and FM bands; c) wide open 24 to 2150 MHz, low noise figure 2 dB gain. Comes with a BNC connector. Requires 12 VDC or 9 V battery.



Tucker SW-500 Portable Shortwave Active Antenna/Tuner \$79

If you want to expand your range or just want to get better reception from the stations you currently listen to, we have developed the new TUCKER SW-500 Active Antenna. This portable (only 1.75" x 5.5" x 4.6") antenna is perfect for indoor use by itself, in conjunction with an outside antenna or both!



Call, Write or Fax For Our **FREE** Catalogs!



Call Now: 800-559-7388

TUCKER ELECTRONICS

1801 Reserve Street, Garland, TX 75042 • P.O. Box 551419, Dallas, TX 75355-1419 • In Dallas: 214-348-8800 • Fax 24 hrs. in English, Español, Français, und auf Deutsch: 214-340-5460



CIRCLE 160 ON READER SERVICE CARD



The Voice of Turkey offers a wide variety of colorful QSLs.



Radio Bulgaria—Radio Sofia in the days when Bulgaria was communist—still is a very friendly station and generous with QSLs.

ernments. These aim to cause unrest in the other states' Kurdish population.

Schedules and frequencies of the Kurdish stations tend to be variable. Unfortunately, most of the time/frequency combinations make the broadcasts difficult or next to impossible to hear in much of North America.

Voice of Iranian Kurdistan—operated by the Iranian Kurdistan Democratic party (PDKI) opposes the Iranian government, and seeks to establish a democracy in Iran as well as obtain autonomy for Kurdistan (it's also anti-U.S.). It is nominally scheduled with broadcasts at 0330, 0900 and 1530 on variable 3740 and 4280.

Voice of the Struggle of Iranian Kurdistan uses the same transmitting facilities as the above station but little else is known

about this broadcaster. This one's schedule is unclear but it seems to be active at 1600, perhaps also at 1500. The frequency is 4355, but it varies down to 4345.

Voice of Iraqi Kurdistan favors the Kurdistan Democratic Party and National Democratic Iraqi Front, and broadcasts from the Kurdish area of northern Iraq. It operates from 0345 to 0500, 1030-1200 and 1545-1815 on 4180 and 5945.

Voice of the People of Kurdistan is operated by the Patriotic Union of Kurdistan (PUK). Reported to be using two lower 4 MHz frequencies—4015 and 4095, and to have extended its schedule after the military activity in the area. It also claims to be broadcasting on 15060.

Voice of Islam/Voice of the Islamic Movement in Iraqi Kurdistan is operated by

the Islamic Movement in Iraqi Kurdistan and broadcasts on 4110, 4400 and 6285 from 1330-1430 in Kurdish and 1430-1530 in Arabic.

Voice of the Iraqi People is operated by the Iraqi Communist Party and is believed to be connected with the Voice of Iraqi Kurdistan. It approximately operates at 0300-0500 and 1700-1745 (Arabic) and 1500-1645 (Kurdish) on variable 3915 and 7095.

Voice of Iraq/Iraqi Broadcasting Corporation supports the Patriotic Union of Kurdistan, with programs from 0540 to 0600 and 1630 to 1650 using 4070, 5880 and 7055.

Voice of the Kurdistan Revolution is a station of the People's Democratic Party of Kurdistan (PDPK), operating from Sulay-

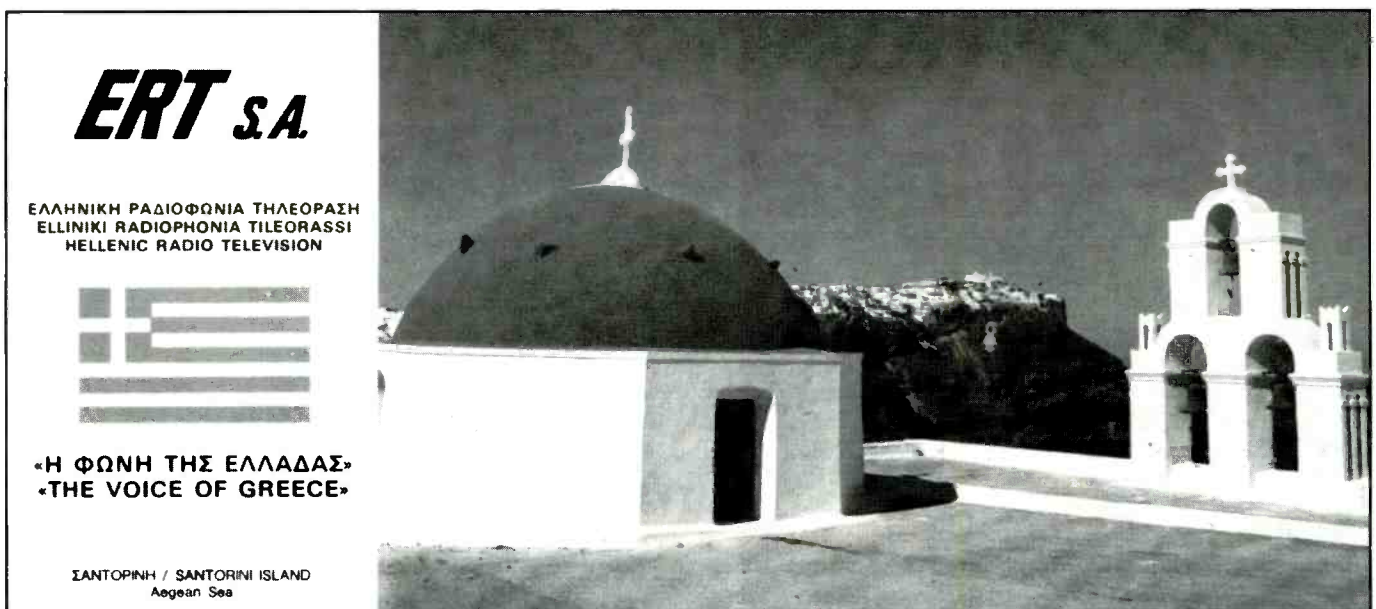

The Voice of Greece is another source of colorful QSLs from this region.

Now The Company That Takes You Around The World Lets You Take The World Around With You.



The Drake SW8 – Finally, Professional Desktop Performance In An Affordable, Portable World Band Shortwave.

The company that has been setting the standards in premium-quality world band shortwave performance now puts top-of-the-line features and technology at your fingertips with the SW8... wherever you want to take it. Designed for both desktop use and easy portability, the

Drake SW8 includes many of the same features that have made Drake a perennial favorite of experts – superb audio, versatility, and the unique combination of professional quality and functional simplicity. So tune in the world and get the best of all worlds – quality and affordability, desktop

technology and portability.

The Drake SW8.

To order your SW8 direct, for more information, or for the dealer nearest you call:

1-800-968-7426

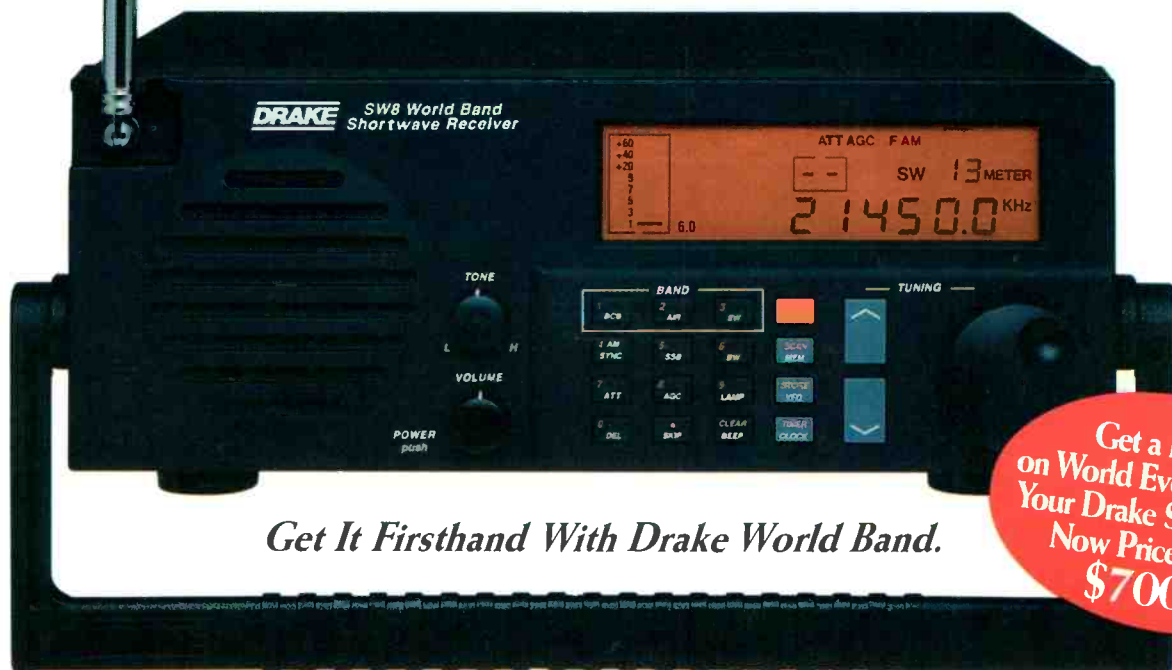

Get It Firsthand With Drake World Band.

**Get a Handle
on World Events...Order
Your Drake SW8 Today.
Now Priced under
\$700.00**

maniyah. Scheduled at 0300-0500 on 6720 and 1400-1600 on 6760.

Voice of Independent Kurdistan, operated by the Kurdish Workers Party (PKK), is believed to operate from one of the PKK's strongholds in northern Iraq. This one currently operates from 0900-1000 and 1400-1500 in the area of 7020-7030.

Again, the time and frequencies of the Kurdish clandestines tend to be variable, sometimes considerably so.

Iraq

Despite embargoes, Saddam Hussein not only continues, but he is widely believed to be rearming at a rapid pace—indeed, suspected of making significant progress in reacquiring the facilities to manufacture nuclear and chemical weapons.

One thing he hasn't done much is to rebuild his shortwave broadcasting facility. Republic of Iraq Radio, also known as Radio Iraq International, remains a shadow of its pre-war self, with only a few active frequencies and a haphazard schedule. A "general service" in Arabic supposedly operates from 0258 to 0025 on 4615 and 6560—and more recently 17740 on occasion. Your best bet may be 6560 in the evenings. The International Service occasionally is reported on 13680 between 1000-1300, but these broadcasts seem to be irregular.

There are a number of clandestine sta-

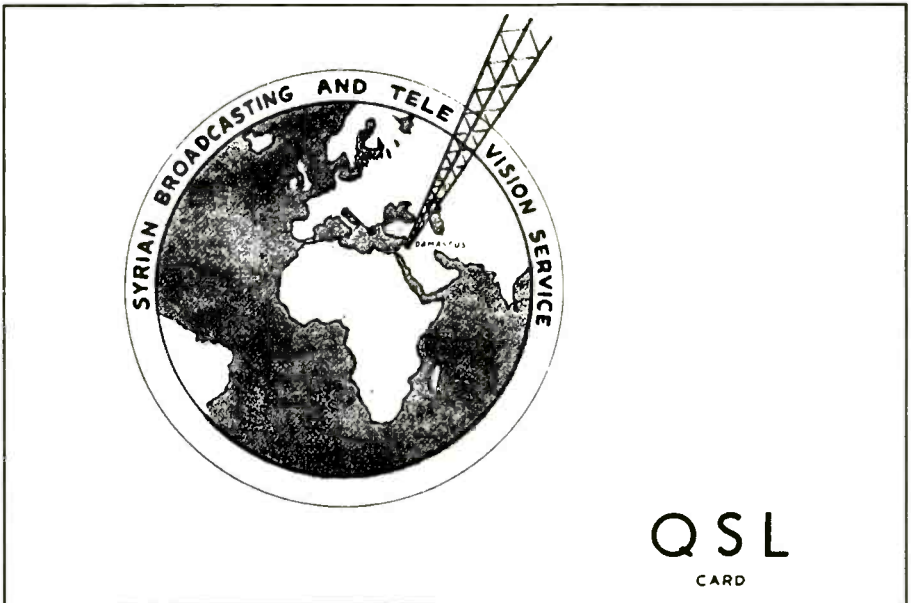

North American service notwithstanding, Radio Damascus is not known for eager replies.

tions targeting Iraq. A couple of the more easily heard:

Radio Freedom—the News Center of Free Iraq—operates on 11695 between 2200 and 0000, but its location and sponsor are unknown.

Voice of Rebellious Iraq supports the Supreme Assembly of the Islamic Revolution of Iraq—an organization sponsored by the Iranian government. The mostly Arabic broadcasts are at 0230-0500, 1100—1330 and 1500-1730 on variable 5555.

TUCKER ELECTRONICS

ICOM

CARRIES THE COMPLETE ICOM RECEIVER LINEUP!

Give us a call today for a complete catalog of these and many other great products to complete your listening post.
TUCKER ELECTRONICS: YOUR COMPLETE SOURCE FOR ICOM RECEIVERS!



Icom IC-R7100A12



Icom IC-R100



Icom IC-R71A

Icom IC-R1-15



Call Now: 800-527-4642

TUCKER
ELECTRONICS

1801 Reserve Street, Garland, TX 75042 • P.O. Box 551419, Dallas, TX 75355-1419 • In Dallas: 214-348-8800 • Fax 24 hs. in English, Español, Français, und auf Deutsch: 214-348-0367

CIRCLE 83 ON READER SERVICE CARD

Scanners/CB/Weather Stations

New Scanner Products Available

Now it's easy to purchase communications, emergency management supplies, weather forecasting equipment and more directly from Communications Electronics Inc. Your free fax-on-demand catalog including un-advertised specials is instantly available by calling 313-663-8888 from your fax machine.

Bearcat Scanners

Monitor police, fire, marine, aircraft, emergency medical transmissions and more with a Bearcat scanner.

Bearcat 9000XLT-R base/mobile	\$374.95
Bearcat 3000XLT-R handheld	\$344.95
Bearcat 890XLT-R base/mobile/weather alert	\$228.95
Bearcat 860XLT-R base	\$154.95
Bearcat 760XLT-R base/mobile	\$189.95
Bearcat 700A-R information mobile	\$148.95
Bearcat 560XLA-R base/mobile	\$76.95
Bearcat 220XLT-R handheld/SPECIAL	\$208.95
Bearcat 178XLT-R base with weather alert	\$128.95
Sportcat 150-R handheld with 800 MHz	\$159.95
Bearcat 148XLT-R base with weather alert	\$83.95
Bearcat 120XLT-R handheld	\$124.95
Bearcat 80XLT-R handheld with 800 MHz	\$159.95
Bearcat BCT7-R information mobile	\$168.95

Weather Stations

Now you can be your own weather reporter with the Davis Weather Monitor II. Our top-of-the-line weather station combines the most advanced weather monitoring technologies available into one incredible package. Glance at the display, and see wind direction and wind speed on the compass rose. Check the barometric trend arrow to see if the pressure is rising or falling. Push a button, and read indoor and outdoor temperature, wind chill, humidity and barometric pressure. Our package deal includes the new ultra high resolution 1/100 inch rain collector part #7852-R, and the external temperature/humidity sensor, part #7859-R. The package deal is order #DAVI-R for \$479.95 plus \$15.00 shipping. If you have a personal computer, when you order the optional Weatherlink computer software for \$139.95, you'll have a powerful computerized weather station at an incredible price. For the IBM PC or equivalent order part #7862-R. Apple Mac Plus or higher including PowerBook, order part number 7866-R.

The Weather Monitor II (7440) comes complete with anemometer with 40 feet of cable, external temperature sensor with 25 feet of cable, junction box with 8 feet of cable, AC-power adapter, detailed instruction booklet and one year limited factory warranty.

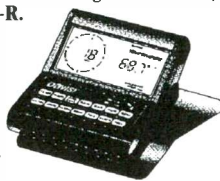

Davis Weather Monitor II 7440-R	\$334.95
Davis Weather Wizard III 7425-R	\$154.95
Davis Perception II Indoor stand-alone weather monitor 7400-R	\$124.95
Davis Remote Display Unit 7815-R	\$84.95
Davis Rain Collector II 0.01" 7852-R	\$59.95
Davis Rain Collector II 0.2 mm 7852METRIC-R	\$59.95
Davis Rain Gauge Stand-alone 0.01" 7520-R	\$79.95
External Temperature/Humidity Sensor 7859-R	\$99.95
Davis Anemometer Mast Mount 7890-R	\$115.95
Weatherlink Software for IBM PC-Version 3.0 7862-R	\$139.95
Weatherlink Software for Apple-Version 3.0 7866-R	\$139.95
4-Conductor 40' (12.2 m) extension cable 7874-R	\$17.95
6-Conductor 40' (12.2 m) extension cable 7878-R	\$21.95
8-Conductor 25' (7.6 m) junction box cable 7880-R	\$14.95
8-Conductor 50' (15.2 m) junction box cable 7881-R	\$24.95
8-Conductor 100' (30.5 m) junction box cable 7882-R	\$44.95
Modem Adaptor 25-Rin for communications port 7870-R	\$9.95
Car/Boat/RV Lighter Power Cord 7873-R	\$9.95
2400 baud modem for Weatherlink MEXT-R	\$39.95
Talking weather card - Call 313-994-9000 for demo IT1-R	\$47.95
Weatherlink language disks: Française, Deutsche, Italiana, Española 7863-R	\$24.95
Barometer, Indoor Hygrometer & Thermometer, Clock/Calendar BA888-R	\$99.95
Indoor-Outdoor Thermometer/Barometer & Hygrometer by OSI BA213-R	\$79.95
Thermometer with transparent calendar & clock display by OSI FC188-R	\$19.95
Thermometer with AM/FM clock radio by Oregon Scientific CR388-R	\$39.95
Indoor/Outdoor Thermometer with Jumbo Display by OSI JB880EX-R	\$24.95

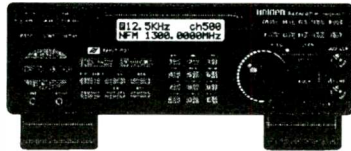

Bearcat® 9000XLT-R Radio Scanner

Mfg. suggested list price \$769.95/CE Special \$374.95
500 Channels • 20 banks • Alpha numeric display
Turbo Scan • VFO Control • 10 Priority channels
Auto Store • Auto Recording • Reception counter
Frequency step resolution 5, 12.5 & 25 KHz.
Size: 10-1/2" Wide x 7-1/2" Deep x 3-3/8" High

Frequency Coverage:
25,000-549,995 MHz., 760,000-823,995 MHz.,
849,0125-868,995 MHz., 894,0125-1,300,000 MHz.

The Bearcat 9000XLT gives you pure scanning satisfaction with amazing features like TurboSearch™ to search VHF channels at 300 steps per second. This base and mobile scanner is ideal for surveillance professionals because it has a selectable attenuator to help eliminate annoying intermodulation from adjacent frequencies in highly populated areas and selectable AM, Wide FM and Narrow FM modes that allow you to change the default receiving mode of the BC9000XLT. Other features include Auto Store - Automatically stores all active frequencies within the specified bank(s). Auto Recording - This feature lets you record channel activity from the scanner onto a tape recorder. Hi-Cut filter to help eliminate unwanted static noise. You can even get an optional CTCSS Tone Board (Continuous Tone Control Squelch System) which allows the squelch to be broken during scanning only when a correct CTCSS tone is received. For maximum scanning enjoyment, order the following optional accessories: PS001 Cigarette lighter power cord for temporary operation from your vehicle's cigarette lighter \$14.95; PS002 DC power cord - enables permanent operation from your vehicle's fuse box \$14.95; MB001 Mobile mounting bracket \$14.95; BC005 CTCSS Tone Board \$54.95; EX711 External speaker with mounting bracket & 10 feet of cable with plug attached \$19.95. The BC9000XLT comes with AC adapter, telescopic antenna, owner's manual and one year limited warranty from Uniden.

CB/GMRS Radios



The Maxon GMRS 210+3 transceiver is a PLL synthesized 10 channel radio on General Mobile Radio Service frequencies. It's the ideal radio for long range communications. Two repeater channels are programmable and one channel (462.675 MHz.) is set aside for emergency and safety communications. The seven remaining interstitial frequencies

462.6875 & 462.7125 MHz are all-purpose GMRS radio channels. 2 watts of RF power for exceptional transmitting range. Up to 5 watts when used with the supplied 12 volt vehicular DC power cord. CTCSS built-in. Includes 450mAh Ni-cad rechargeable battery pack, AC/DC wall battery charger, owner's manual, FCC license application, belt clip, antenna. Call 1-800-USA-SCAN to order.

Maxon GMRS210+3-R1 GMRS transceiver \$188.95

SPECIAL Buy 2 or more GMR210+3 at \$174.95 each

WTA3DT-R1 Ni-cad battery charger for WTA6GN4 & WTA6GN2	\$69.95
WTA6GN4-R1 Ni-cad pack gives 4 watts power with 210+3	\$69.95
WTA6GN2-R1 Ni-cad pack gives 2 watts power with 210+3	\$29.95
WTA6GA-R1 Alkaline battery case - requires 6 AA batteries	\$9.95
WTA8GA-R1 Carrying case for Maxon GMR210+3	\$29.95
WTA10G-R1 Speaker/microphone for Maxon GMR210+3	\$18.95
WTA13G-R1 Push-to-talk mini-VOX headset for GMR210+3	\$47.95
WTA14-R1 Antenna adaptor/screw-in male to BNC connector	\$9.95
ANT4GM-R1 1/4 wave UHF magnetic mount mobile antenna	\$29.95
Cobra 2010GLTWX-R SSB base with weather alert	\$379.95
Cobra 148FGTLR-CB with frequency counter	\$209.95
Cobra 29LTDWX-R CB with weather alert	\$114.95
Cobra HH40-R CB 40 channel handheld transceiver	\$99.95
Ranger RC12950-R 25 watt 10 meter transceiver	\$239.95
Uniden GMR100-R GMRS handheld transceiver	\$144.95
Uniden WASHINGTON-R SSB CB Base († \$25.00 shipping)	\$199.95
Uniden GRANTXL-R SSB CB Mobile	\$139.95
Uniden PRO538W-R CB & Weather	\$59.95



VHF Transceiver

RELM® WHS150-R Transceiver/SPECIAL

Mfg. suggested list price \$481.67/CE price \$299.95
Police and fire departments depend on the RELM WHS150 transceiver for direct two-way communications with their police, fire department, civil defense agency or ham radio repeater. The WHS150 is our most popular programmable five watt, 16 channel handheld transceiver that has built-in CTCSS, which may be programmed for any 39 standard EIA tones. Frequency range 148.000 to 174.000 MHz. Will also work 144.000-148.000 MHz with slightly reduced performance. The full function, DTMF compatible keypad also allows for DTMF Encode/Decode and programmable ANI. Weighing only 15.5 oz., it features dealer programmable synthesized frequencies either simplex or half duplex in both 5.0 and 6.25 KHz. increments. Other features include scan list, priority channel, selectable scan delay, selectable 5 watt/1 watt power levels, liquid crystal display, time-out timer and much more. When you order the WHS150 from Communications Electronics Inc., you'll get a complete package deal including antenna, battery, belt clip and user operating instructions. Other accessories are available. A leather carrying case with swivel belt loop part #LCWHS is \$49.95; rapid charge battery charger, part #BCWHS is \$69.95; speaker/microphone, part #SMWHS is \$54.95; extra ni-cad battery pack, part #BP007 is \$59.95. The radio technician maintaining your radio system must order programming instructions part #P1150 for \$18.00 to activate this radio. FCC license required for United States operation.

Other neat stuff

WX70-R weather radio with National Weather Service storm alert	\$39.95
WB-R USA Today The Weather Book, Guide to USA weather by Jack Williams	\$15.95
PSUN-R Parly Sunny, Weather Junkie's Guide to Weather by Alan Fields	\$11.95
Grundig Satellit 700-R digital portable shortwave with 512 memory	\$459.95
Grundig Yacht Boy 400-R digital portable shortwave - 40 memory	\$179.95
Grundig Yacht Boy 230-R portable shortwave receiver	\$109.95
Sangean AT5800-R portable 20 memory shortwave receiver	\$69.95
Sangean AT5803A-R portable shortwave w/AC adapter - 9 memory	\$129.95
Sangean AT5808-R1 portable 45 memory shortwave receiver	\$129.95
Uniden EXP9200-R 900 MHz. 1 or 2 line spread spectrum cordless phone	\$289.95
Uniden EXP9100-R 900 MHz. 1 line cordless spread spectrum telephone	\$229.95
Bogen FR3110-R Digital FAX Friday Fax-on-Demand & answering system	\$399.95
Bogen FR3020-R memory module for Fax Friday/up to 36 minutes	\$99.95
Bogen FR2000-R Digital two-line voice mail & answering machine	\$279.95
Bogen FR0018-R memory module, doubles recording time to 36 minutes	\$79.95
FANS P161P-R 60 name/number caller ID, unwanted call blocker, paging	\$149.95
SNI ID200-R Bouncer name/number caller ID, call reject, forward	\$89.95
ICOM GP22-R handheld global positioning system (GPS)	\$494.95
RELM WHS150-R VHF handheld 5 watt, 16 channel transceiver	\$299.95
RELM RH256NR-R VHF 25 watt, 16 channel synthesized transceiver	\$289.95
Ranger RC12950-R 25 watt 10 meter ham radio transceiver	\$239.95
Cobra RD17125W-R Safety Alert & Super Wideband Laser/Radar receiver	\$159.95
Uniden LR9900SW-R Super Wideband Laser/Radar receiver	\$139.95
ANTK-R VHF scanner/VHF transmitting antenna PL259 connector	\$29.95
ANTMMBNC-R magnet mount scanner antenna w/ BNC connector	\$29.95
ANTMMOT-R magnet mount scan antenna w/Motorola plug	\$29.95
ANTMPLR-R magnet mount scan antenna with PL259 connector	\$29.95
ANTSGBNC-R glass mount scanner antenna with BNC connector	\$29.95
ANTSGMOT-R glass mount scanner antenna with Motorola jack	\$29.95

Buy with confidence

It's easy to order from us. Mail orders to: Communications Electronics Inc., P.O. Box 1045, Ann Arbor, Michigan 48106 U.S.A. Add \$15.00 per radio product or weather station for U.P.S. ground shipping and handling in the continental U.S.A. unless otherwise stated. Add \$10.00 shipping for all accessories and publications. Add \$10.00 shipping per antenna. For Canada, Puerto Rico, Hawaii, Alaska, Guam, P.O. Box, or APO/FPO delivery, shipping charges are two times continental U.S. rates. Michigan residents add state sales tax. No COD's. Satisfaction guaranteed or return item in 31 days for refund, less shipping. 10% surcharge for net 10 billing to qualified accounts. All sales are subject to availability, acceptance and verification. Prices, terms and specifications are subject to change without notice. We welcome your Discover, Visa, American Express or MasterCard. Call anytime 1-800-USA-SCAN or 800-872-7226 to order toll-free. Call 313-996-8888 if outside the U.S.A. FAX anytime, dial 313-663-8888. For technical assistance, call our technical support hotline for \$2.00 per minute at 1-900-555-SCAN. Dealer and international inquiries invited. Dial 313-663-8888 for fax-on-demand info. Price schedule effective 8/20/95 add #080195WX Copyright © 1995 Communications Electronics Inc.

For credit card orders call
1-800-USA-SCAN

COMMUNICATIONS ELECTRONICS INC.

Emergency Operations Center

P.O. Box 1045, Ann Arbor, Michigan 48106-1045 U.S.A.
For information call 313-996-8888 or FAX 313-663-8888

Iran

The Tehran government is believed by U.S. authorities to be today's No. 1 sponsor of terrorism. It's also moving full steam ahead to increase its military power and is believed to be just a few years away from being able to produce nuclear weapons.

The government broadcaster, The Voice of the Islamic Republic of Iran, is an easy catch. You can find its 24-hour-a-day broadcasts to Europe on 15084, relaying the "First Program" from the domestic service. English to North America airs at 0030-0130 on 6175, 7100 and 9022. You can also log the English broadcast for Europe at 1930-2030 on 9022 and 11965.

Like Iraq, Iran is the target of a number of clandestine stations, including:

Radio Azadi (Radio Freedom), operated by the National Resistance Movement of Iran and believed to be transmitting from Egypt. It airs programs in Farsi from 0230-0300 and 1830-1930 on 9400 and 15560.

Voice of Human Rights and Freedom for Iran—has operated under a number of names since it began in 1983 (Radio Nejat-e-Iran, Iran's Flag of Freedom, etc.) and is affiliated with a number of different organizations that seek to change the Tehran government. It is one of the more easily heard clandestines from this area. Sched-

uled from 0230-0425 on 9380; 0600-0645 on 15150; and 1630-1825 on 9270 and 11470.

Voice of the Mojahed is sponsored by the People's Mojahedin Organization of Iran and the National Liberation Army of Iran. It operates on many frequencies, most of them useless for our purposes. Try 0200-0600 and 1400-1900 on variables 8840, 9060 and 9240.

Syria

The area of northern Iraq that Turkey occupied practically touches the northeast corner of Syria, where a Kurdish population also lives.

Syria's Radio Damascus is a pretty easy catch in North America. There are nearly back-to-back hourlong English language broadcasts at 2005 (to Europe) and 2110 to America both on 12085 and 15095.

Three ex-U.S.S.R. republics border on Turkey and each of the governments is having trouble maintaining a grip on power, not to mention its own sovereign territory.

Azerbaijan

This was the site of one of the first crises in the post-U.S.S.R. world. Indeed, the civil war over the Nagorno-Karabakh area was under way before the Soviet Union's demise. There was an attempted coup in Baku last fall.

Radio Baku, also known as Radio Dada Gorgud, is no more easily picked up now than when it was a part of the U.S.S.R. There's a service to Europe on 7160 at 1900 but that's useless here. Try the outlets on 4957.5 or 4785 around local dawn. They're also heard on occasion during the 0300-0400 period on those frequencies.

Armenia

Radio Yerevan, also known as Araks News Agency, is listed for some English to America—at 2230-2245 on 11920 and 17770, but is seldom reported.

A new "station" is Radio Intercontinental, a religious broadcaster using the government's transmitters to air programs of its own as well as those of other groups. It operates on 9480 (also listed for 11790 and 15400 at 0630 and 2200 in German) and has lately been heard with a program called Radio Voice of the Martyrs, airing at 1800, though perhaps not consistently. Another independently produced religious program, Radio Mitternachtstruf, is aired in German at 2200. The Voice of Russia also uses 9480 from Yerevan at other hours.

Georgia

This former Soviet republic also is the scene of a breakaway independence movement: the Abkhazians and the residents of southern Ossetia want their own state.

Radio Georgia put an international service on the air a couple of years ago but it's only directed to Europe so the BBC it's

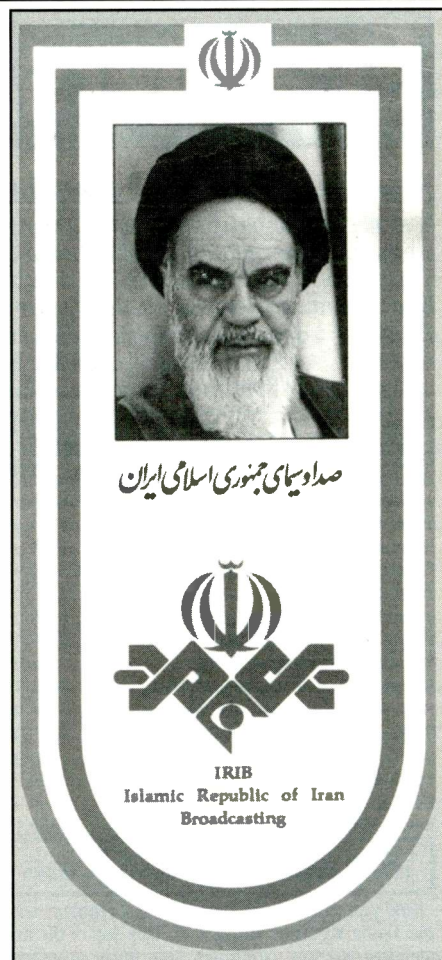

This VOIRI QSL of five years ago features a friendly face we know so well.

not! Information on the exact schedule is conflicting, but try the half-hour English broadcasts at 0730 on 11805, 1100 on 11815, 1900 on 11805, 2100 on 6180.

A recently reactivated station is Abkhaz Radio, based at Sukhumi, the capital of the Abkhaz region. Again, the schedule is indefinite but seems to be 0430 to 0530 or later, and again from 1500, all on 9505 or just a hair below. The broadcasts are announced as being on Wednesdays and Saturdays only, but have been heard on other days as well.

Bulgaria

Bulgaria sits on Turkey's northwest border, 100 miles or so from Istanbul.

Radio Bulgaria offers regular reception with its English language broadcasts to North America, at 2300-0000 and 0400-0500 on 9700 and 11720.

More interesting to the DX hound or curiosity seeker is the "Horizont" domestic service in Bulgarian on 11660 from 0300 to 1700. Also the Radio Varna relay, which broadcasts tourist information from 2200-2300 Fridays on 7260. The Voice of America uses Radio Bulgaria's Plovdiv transmitter site for relays to west Africa,

20th Annual Virginia Beach HamFest & Computer Fair™

ARRL Virginia State Convention
Sept. 23 & 24, 1995



- ★ Major Commercial Exhibitors, Dealers & Organizations
- ★ Amateur Exams & Upgrades
- ★ DX and Technical Forums
- ★ Computer Hardware, Software and Accessories
- ★ Plenty of FREE PARKING
- ★ Held at the Va. Beach Pavilion
- ★ Talk-In on 146.97 MHZ
- ★ Speakers: Wayne Green & Gordon West
- ★ Saturday night banquet

Admission Tickets
\$6.00

Tickets Good Both
Days!

HamFest Information Line
1-804-HAMFEST

Tickets & General Info: Exhibitor and Dealer Info:

Manny Steiner, K4DOR Lewis Steingold, W4BLO
3512 Olympia Lane 1008 Crabbers Cove Lane
Virginia Beach, VA 23452 Virginia Beach, VA 23452

Send SASE - Checks Payable to TRCI, Inc.

CIRCLE 85 ON READER SERVICE CARD

TRT – THE VOICE OF TURKEY

BROADCASTING ZONES

- 1 - EUROPE
- 2 - NORTH EAST AMERICA
- 3 - BALKANS
- 4 - MIDDLE EAST
- 5 - NORTH AFRICA
- 6 - NORTH WEST ASIA AND FAR EAST
- 7 - SOUTH WEST ASIA
- 8 - SOUTH EAST ASIA

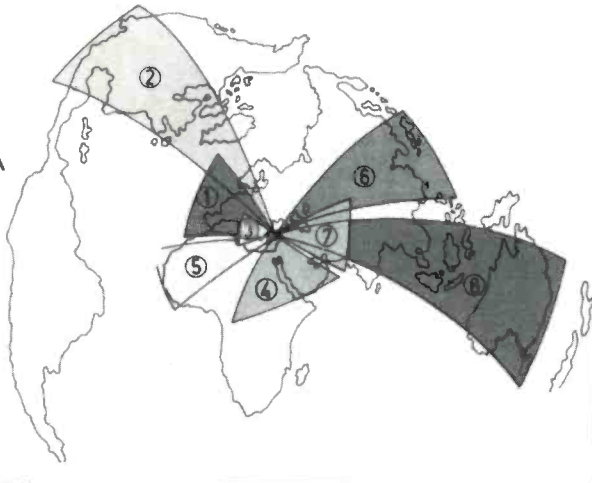

The Voice of Turkey's shortwave broadcasts cover a good portion of the globe.

You also can pick up the Greek regional station at Thessaloniki, Radiophonikos Stathmos Makedonias, a shortwave relay of a regional program service. It is scheduled on 9935 and 11595 from 0600 to 2255 and on 7430 from 1400 to 2255, all in Greek.

Turkey

The Voice of Turkey is another easy pick, with its daily English language broadcasts to North America at 0300 to 0350 and 2200 to 2250 (an hour later in winter months), all on 9455.

Of special interest to the DXer are two lower power stations. Turkish Police Radio can be heard in North America on occasion, but the feat probably will demand many, many tries. It operates on 7370 and is best caught at its sign-on at 0458. Somewhat more often heard is the Turkish State Meteorological Service on 6900, which also signs on at 0458, carrying weather reports and Turkish music.

That's our radio tour of troubled Turkey and the borderland states—most of which also have more than their share of serious problems—and some seem anxious to cause problems for others. Who knows what headlines this mix of poor economies, ethnic hatred, breakaway regions, militants, fundamentalists and an ever-growing stockpile of armaments may bring one day.

scheduled on 13680 from 1800-1900 and 15080 from 1600-0630.

Greece

A small bit of Turkey borders on Greece, just below the Turkish-Bulgarian border. There's certainly no love lost between these two archenemies who have squabbled over

Cyprus for years and once even fought a war there.

The Voice of Greece is an easy catch in North America. Broadcasts are mostly Greek but do contain two English language newscasts each evening that run about 10 minutes each. These currently air at 0131 and 0341 on 6260, 7448 and 9435.

Pager Decoder Pager Decoder Pager Decoder

Message Tracker 2.0

Call for Information on our Plus and Pro Versions

Decode digital pager messages using your PC and scanner. Adaptor connects to your RS-232 port and audio output jack on scanner. The Message Tracker software program allows you to select various options and features.

Starting At
\$139⁹⁵

S & H within U.S.: \$4
(outside U.S.: \$10)

Tx Residents add 8.25% Sales Tax

Advanced Features Include:

- Decodes FSK Signals
- POCSAG - 512 1200 2400 baud
- GOLAY (600 baud)
- Auto Baud Rate Detection
- Handles GOLAY and multi-speed POCSAG modes on same frequency
- Allows option to monitor all messages on channel
- Ability to monitor messages only from your capcode address list
- Output to File with Time Stamp
- Displays both Alpha and Numeric Messages
- Connects to speaker/earphone jack or directly to discriminator output

We currently accept checks and money orders only. Call for latest product and ordering information.

Mail Your Order Today!!!

Name: _____
 Addr: _____
 City: _____
 State: _____ Zip: _____
 Phone: _____
 E-mail: _____
 Message Tracker 2.0 : \$ 139.95
 S & H: \$ _____
 Tx Residents:(8.25%): \$ _____
 Total Purchase: \$ _____

K & L Technology
 P.O. Box 460838
 Garland, Tx 75046-0838

Phone/Fax: 214-414-7198
 E-mail: KLTsupport@aol.com

Min. Recommended System : 386

Pager Decoder Pager Decoder Pager Decoder

FINALLY - NOW AVAILABLE IN THE USA

The Decoder that is the STANDARD of the European Continent.

HOKA CODE-3 USA Version

Many radio amateurs and SWLs are puzzled! Just what are all those strange signals you can hear but not identify on the Short Wave Bands? A few of them such as CW, RTTY, Packet and Amtor you'll know - but what about the many other signals?

There are some well known CW/RTTY Decoders but then there is CODE-3. It's up to you to make the choice, but it will be easy once you see CODE-3. CODE-3 has an exclusive auto-classification module that tells YOU what you're listening to AND automatically sets you up to start decoding. No other decoder can do this on ALL the modes listed below - and most more expensive decoders have no means of identifying ANY received signals! Why spend more money for other decoders with FEWER features? CODE-3 works on any IBM-compatible computer with MS-DOS with at least 640kb of RAM, and a CGA monitor. CODE-3 includes software, a complete audio to digital FSK converter with built-in 115V ac power supply, and a RS-232 cable, ready to use.

CODE-3 is the most sophisticated decoder available for ANY amount of money, and the best news of all, is that it is available from a United States dealer.

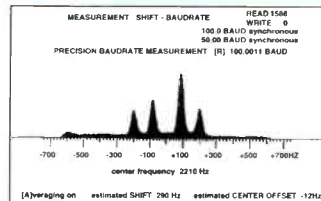

Simulated Speed Measurement Module

26 Modes Included in standard package include:

- Morse
- RTTY/Baudot/Murray
- Sitor CCIR 625/476-4
- ARQ - Navtex
- AX25 Packet
- Facsimile all RPM (up to 16 gray shades at 1024 x 768 pixels)
- Autospec - Mk's I and II
- DUP-ARQ Artrac
- Twinplex
- ASCII
- ARQ-90/98
- SI-ARQ/ARQ-S
- SWED-ARQ-ARQ-SWE
- ARQ-E/ARQ1000 Duplex
- ARQ-N-ARQ1000 Duplex Variant
- ARQ-E3-CCIR519 Variant
- POL-ARQ 100 Baud Duplex ARQ
- TDM242/ARQ-M2/4-242
- TDM342/ARQ-M2/4
- FEC-A FEC100A/FEC101
- FEC-S * FEC1000 Simplex
- Sports info 300 baud ASCII
- Hellsreiber-Synch/Asynch
- Sitor • RAW (Normal Sitor but without Synch.
- ARQ-70
- Baudot F788N
- Pactor
- WEFAX

Available as extra options

- Option 3 Piccolo\$85.00
- Option 4 Coquelle.....\$85.00
- Option 5 4 special ARQ & FEC systems TORG-10/11, ROU-FEC/ RUM-FEC, HC-ARQ (iCRC) and HNG-FEC\$115.00
- Option 8 SYNOP decoder. \$85.00

- All modes in typical baud rates with possibility of changing to any desired value of speed and shift.
- All options are available from the main menu, saving or loading to and from hard/floppy drive in bit form, means no loss of unknown signals!

HURRY! For a limited time the Standard CODE-3 package includes FOUR options:

1. OSCILLOSCOPE 2. ASCII STORAGE 6. AUTO CLASSIFY 7. PACTOR
- Live Support after the sale. Computer Aided Technologies is dedicated to customer support!

ORDER NOW

STANDARD CODE-3 PACKAGE \$595.00
ALL FOUR EXTRA OPTIONS - \$199.95

ORDER NOW

NOW AVAILABLE — CODE-30 DSP-Based Decoder with all above options. SCALL (318) 687-2555 (SHIPPING & HANDLING \$10.00) DEMO (SLIDE) DISK ONLY \$5.00 DEALER INQUIRIES INVITED

COMPUTER AIDED TECHNOLOGIES

P.O. Box 18285 - SHREVEPORT, LA 71138

ORDERS ONLY - (318) 636-1234 FAX (318) 686-0449 (24 Hrs)
 Live Tech Support (318) 687-2555 - (9 a.m. to 1 p.m. Central M-F)
 NiteTime BBS (SCANCAT File Area) (318) 631-3082 (7 p.m. - 6 a.m. Central)
 Online support available on Genie. • E-mail • j.springer7@gets.com

(See our ad on page 78 & 81)

Remembering Radio

An Arizona Pioneer

BY ALICE BRANNIGAN

The U.S. Department of Commerce granted a license on September 6, 1922, to the Neilson Radio and Sporting Goods Company to operate a new broadcast station on 360 meters at Phoenix, Arizona. Sequentially-issued call letters KFCB were assigned to the station, located at 311 North Central Avenue, Phoenix, and went on the air September 6, 1922, with the 10 watts of power under the directorship of Earl A. Neilson.

In May 1923, KFCB was reassigned to operate on 1080 kHz. Its first license expired in June 1923, and it temporarily left the air. In July 1923, KFCB was relicensed to the Neilson Radio Supply Company, still owned by Mr. Neilson. By 1924, it operated daily (except Wednesday) from 7 p.m. until 7:30 p.m. The "Class A" station remained located in the four-story concrete business block at 311 North Central (it later housed the city fire department offices and is now the site of a parking lot).

In late 1924, the station changed frequency to 1260 kHz and concurrently increased power to 50 watts. By February 1925, KFCB operated Wednesday and Friday between 7:30 p.m. and 8:30 p.m., using the air motto "The Pioneer Sports-casters." KFCB's owner was engaged in the sale of sporting goods as well as receivers and supplies. Power was increased to 100 watts in early 1926, and increased again in the spring of 1927 to 150 watts. The newly empowered Federal Radio Commission shifted the Phoenix station to 1230 kHz in June 1927. At this time, its slogan, used both on the air and off, was "Kind Friends Come Back."

By way of a major frequency reallocation plan taking place at 3 a.m., Saturday, November 11, 1928—a date that found most United States broadcast stations switching to new dial positions—KFCB changed frequency to 1390 kHz. Also in November, power was reduced to 100 watts. The FRC authorized KFCB to change call letters to KOY on February 8, 1929. KFCB moved from 311 North Central to newer quarters at 621 North Central (the old Sands Building) and raised power from 100 to 250 watts on March 28, 1929. Call letters KOY debuted in May 1929, when it inaugurated its new power level and transmitting site. Late summer 1929, power was increased again—now to 500 watts.

KOY joined the Columbia chain as its Phoenix area affiliate in February 1932. Studio and transmitter at this time were

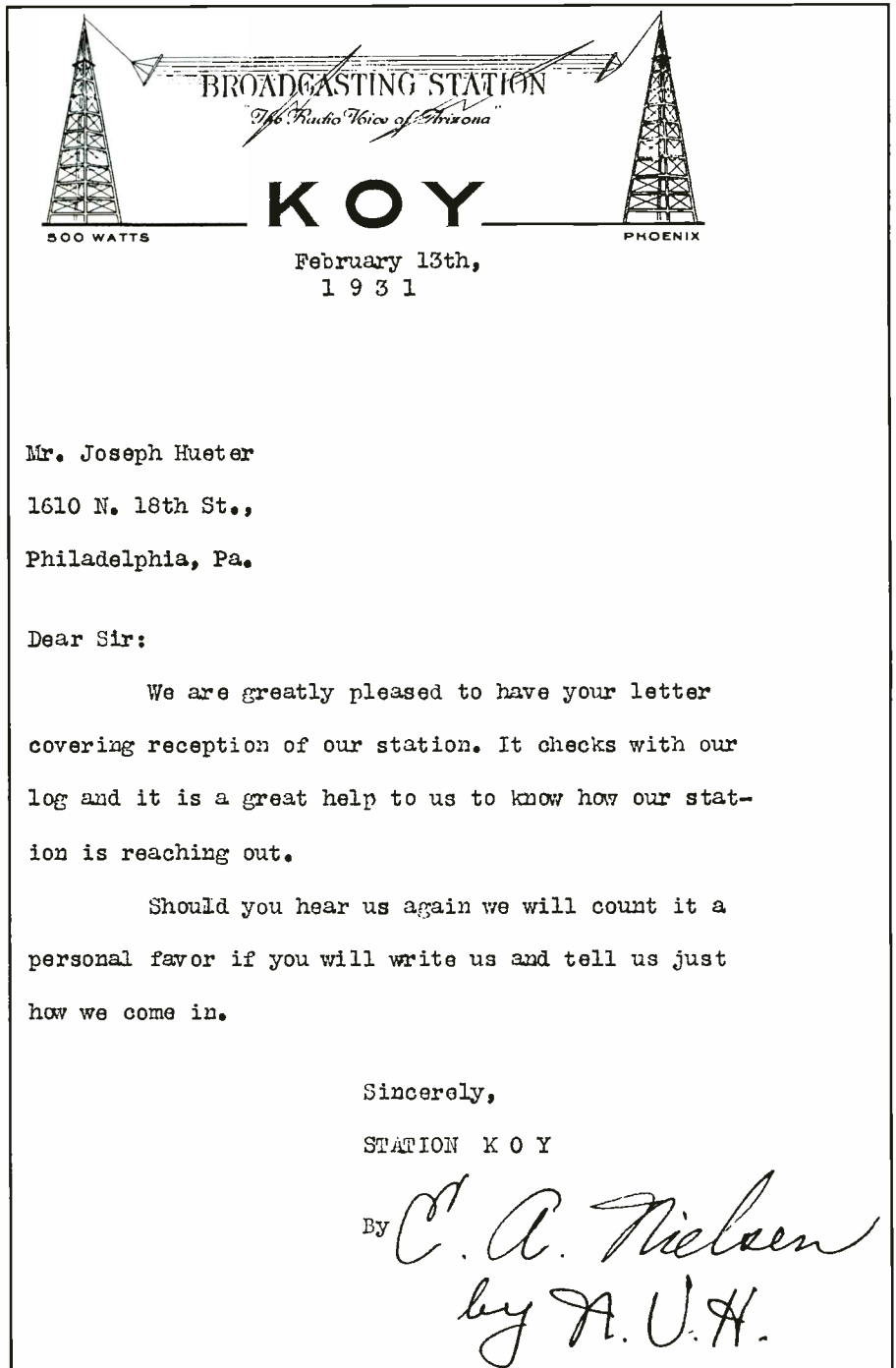

Mr. Joseph Hueter

1610 N. 18th St.,

Philadelphia, Pa.

Dear Sir:

We are greatly pleased to have your letter covering reception of our station. It checks with our log and it is a great help to us to know how our station is reaching out.

Should you hear us again we will count it a personal favor if you will write us and tell us just how we come in.

Sincerely,

STATION K O Y

By C. A. Nielsen
by A. U. H.

A cordial 1931 veri letter from KOY, Phoenix.

located at 621-623 North Central Avenue. Daytime power was increased from 500 to 1,000 watts on January 10, 1933; nighttime power remained at 500 watts. Station director at this time was founder Earl A.

Neilson. CBS network programming was dropped by 1934. Program director by 1935 was John R. "Jack" Williams.

KOY was acquired from the Neilson Radio and Sporting Goods Company by The



The KOY Building—as it looked in 1974. (Photo by J.D. Lowry)

Salt River Broadcasting Company on November 10, 1936. Principals were Burridge D. Butler and Naylor Rogers; the former associated with WLS Chicago, and the latter formerly manager of KNX at Hollywood. While Mr. Butler became KOY's new president, Earl Neilson continued on as general manager. On December 15, 1936, KOY was granted FCC permission to move its transmitter and install a new vertical radiating antenna tower to replace

its old flat-top antenna on Central Avenue, which fell from its supports onto a hotel earlier in 1936.

In March 1937, KOY moved studios from 621 North Central to 838 North Central and transmitting location to a 20-acre site at 12th Street and Camelback Road. The \$55,000 facility included a newly constructed one-story stucco transmitter house and adjacent 289-foot self-supported Blaw-Knox steel vertical radiator. Full-time

power was raised to 1,000 watts. A license covering these changes was issued to KOY by the FCC on April 2, 1937. Fred A. Palmer succeeded Earl Neilson as station manager of KOY in 1937. In late 1937, KOY reaffiliated with the CBS network and organized the Arizona Network as the new statewide chain's key affiliate.

Studios were moved again slightly in late 1938 to 836 North Central Avenue (the KOY Building). At this time, KOY operated daily from 6:30 a.m. until 11:45 p.m. The Phoenix station was granted an FCC construction permit March 13, 1940, to change frequency from 1390 to 550 kHz, a dial position long sought by the CBS affiliate. This move was carried out in June of 1940. In 1941, J.A. Reilly was named general manager of KOY, but was succeeded in that post by Harold A. Safford a year later. Albert D. Johnson was appointed general manager in 1944. In 1945, KOY's studio address became 840 North Central Avenue (no physical change—still "The KOY Building").

Owner and President Burridge Davenal Butler died at age 80 on March 30, 1948, requiring the sale of his broadcast properties, KOY at Phoenix, KTUC at Tucson, and WLS at Chicago, Illinois. The Salt River Broadcasting Company was transferred to John L. Hogg, commercial manager of KOY, and his associates in late 1948. It was then that Mr. Hogg became president

Tone Decoder with Serial Interface

A Must For Icom R7000, R7100 and R9000

The DC440 is a powerful yet flexible instrument for decoding sub-audible and digital signaling tones as well as Touch-Tone® characters. The DC440 monitors the demodulated audio output from a Communications Receiver, Service Monitor, Scanner or Interceptor®. The DC440 automatically decodes CTCSS tones, DCS codes and DTMF Touch Tone® characters. In addition, the DC440 can be interfaced with the CX-12AR (CI-V to RS-232C interface converter) to allow for complete computer control and Automatic Data Logging of Icom CI-V receivers (R7000, R7100 and R9000). Several different devices can be connected to the bus simultaneously. Great for portable test systems, where only one serial port is available. The DC440 and CX-12AR are supported by Scanstar, ScanCat and ScannerWEAR for Windows.

Applications

- Use with any Scanner or Receiver for Off-The-Air measurements (may require internal connection to discriminator for CTCSS and DCS)
- Use with Receiver & PC to automatically survey busy communication channels for tone and code usage
- Ideal for repeater operators to monitor users
- Direct connection to Optoelectronics R10 Interceptor® for CTCSS, DTMF, FM deviation and signal strength measurement system

Features

- Simultaneous off air measurement of 50 CTCSS tones, 106 DCS codes, and 16 DTMF characters
- Six measurement modes
- Serial Data Interface with CX-12AR (optional)
- Decoding Activity Indicator
- Compact, ideal for mobile or portable operation (optional NiCad Batteries)
- 16 Character back-lit LCD Display
- Interface with Icom CI-V receivers (R7000, R7100, and R9000) for computer control



Size: 1.8" high x 4.5" wide x 4" deep

\$259

OPTOELECTRONICS®

Order Line: (800) 327-5912 • Tel: (305) 771-2050 • Fax: (305) 771-2052

5821 NE 14th Avenue Fort Lauderdale, Florida 33334

All prices and specifications are subject to change without notice or obligation. **MADE IN THE U.S.A.**

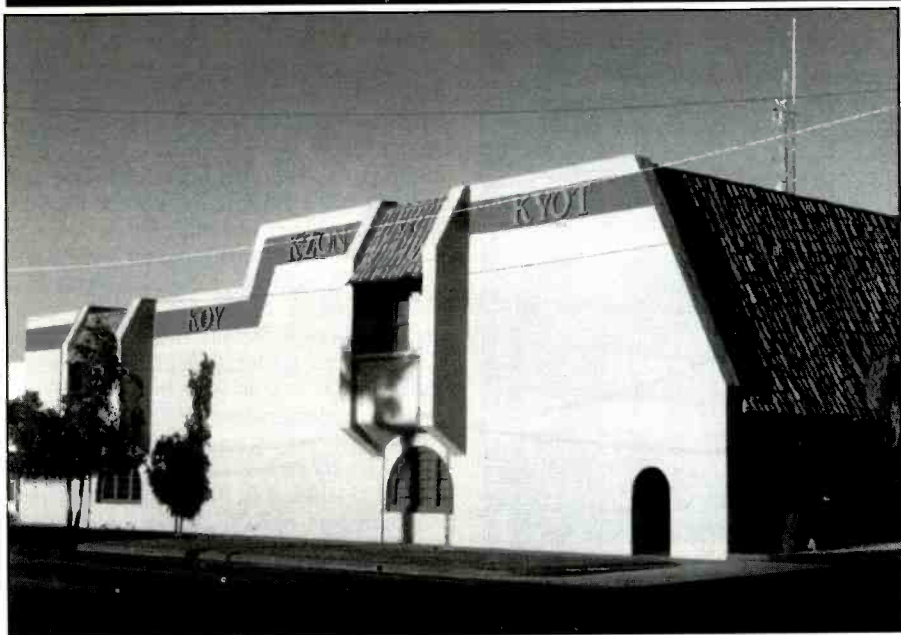

After being remodeled in the 1980s, the KOY Building now looks like this. (Photo by J.D. Lowry)

of KOY. In early 1949, power of the station was increased to 5,000 watts during the daylight hours; nighttime power remained at the 1,000-watt level. A new Western Electric 5-kW transmitter was installed at its 12th Street and Camelback

Road site with its old 1-kW W-E unit reverting to standby use.

On January 1, 1950, KOY relinquished its CBS network affiliation to another Phoenix station (KOOL), but remained as the key Arizona Network station. By the

end of January 1, an affiliation was secured with the Mutual Broadcasting System and the Don Lee Networks. On April 11, 1951, KOY's licensee name was changed to The KOY Broadcasting Company in a reorganization that saw John L. Hogg retaining his ownership and position as president of KOY and Albert D. Johnson continuing as general manager. The ownership interest of Mr. Johnson and Irving Jennings was acquired by the other owners at this time.

Renovated studios were opened in June 1951, at 840 North Central Avenue. By 1954, KOY operated 24 hours a day (17 hours on Sunday). In late 1954, James W. Ross joined KOY in the newly created position of station manager. He filled this post until late in 1957 when he became commercial manager. The station joined the ABC radio network in early 1958 while continuing as key Arizona Network affiliate. Programming from Mutual-Don Lee also was aired. The west coast-based Don Lee Broadcasting System was discontinued in 1958. On October 30, 1960, KOY became an exclusive ABC affiliate; Mutual Network programming then was dropped. Its Arizona Network liaison was unaffected by this switch.

James W. Ross was appointed station manager of KOY in 1962. KOY saw other changes in 1966. Its affiliation with the ABC Radio Network expired in 1966. President and General Manager John L.

For all your scanner and shortwave questions



Ask Bob!

Bob Grove, Publisher of *Monitoring Times* magazine

Q: What is the "gurgly-beep-beep" sound that interferes with my scanner reception?

—R.B., Kansas City, MO.

A: The fact that you're in Kansas City is a giveaway. Strong signal overload, "intermod" from high power digital pagers, is a common complaint among metro scanner listeners. Filters like the Grove Scanner Filter can help reduce this annoying interference.

The **FREE Grove Catalog and Buyer's Guide** is your best source for information and products. Call today!



Grove Enterprises, Inc.
300 S. Hwy. 64 W.
Brasstown, N.C. 28902
1-800-438-8155; Fax 704-837-2216
Internet Address: www.grove.net

DELTACOMM™ DSS

Digital Signal Strength Option For Your ICOM™ R7000

DELTACOMM™ I-7000 and your MS-DOS computer integrated with the Delta Research custom CI-V interface and optimized software will not just control but will maximize the potential of your ICOM™ IC-R7000's monitoring capability.

- CYBERSCAN function allows scan file tracking control of systems employing frequency hopping techniques.
- Spectrum log at speeds in excess of 1300 channels a minute, generate a real time histogram of activity and create scan database file automatically.
- Birdie log during frequency search automatically characterizes your R7000, then locks out those frequencies.
- Activity log function continuously monitors and logs all frequencies of a scan database while displaying active, was active and never active channels.



Optional DELTACOMM™ DSS (Digital Signal Strength) upgrade for your DELTACOMM™ I-7000 communication manager.

- Innovative interface design allows digitizing and storing the R7000 signal level information with 8-bit accuracy via your computer's game/joystick port.
- DSS allows user programmable upper and/or lower signal level detection limits during DELTACOMM™ I-7000's spectrum log, scan and search functions.
- Log signal strength information to printer or delimited log file while DELTACOMM™ I-7000 is scanning or activity logging the selected database file.

DELTACOMM™ I-7000 communication manager program includes all cabling, manual, UL listed power supply and Delta Research custom CI-V interface for \$299.00 + \$8.00 (U.S.) or \$25.00 (foreign) S&H. The DELTACOMM™ DSS interface upgrade comes complete with easy to follow NO SOLDER installation instructions, all cabling and 8-bit DSS A/D converter module (game port required) for \$99.00 + \$8.00 (U.S.) or \$25.00 (foreign) S&H and is available as an upgrade option to registered I-7000 users. Contact us for additional information on DELTACOMM™ communication managers for ICOM™ R7100, R71A, R72 and IC735.



Delta Research



Box 13677 • Wauwatosa, WI 53213 • FAX/Phone (414) 353-4567

Hogg died April 26, 1966. In May, Vice President Glenn Snyder became chairman of the board of the KOY Broadcasting Company, while Jack Williams, secretary and assistant to the president, was named president of the firm. (In late 1966, Mr. Williams was elected governor of Arizona). And James W. Ross rose to vice president and general manager of KOY.

In May 1967, the station again changed ownership. Acquiring KOY from the KOY Broadcasting Company (Glenn Snyder and Governor Jack Williams, et. al.) was the Southern Broadcasting Company (John G. Johnson, president and 11.28 percent owner) for \$1.9 million in a sale gaining FCC approval on March 29. This was KOY's fourth ownership change. In June 1967, the station was transferred from the soon-to-be-dissolved KOY Broadcasting Company to the parent Southern Broadcasting Company (a corporation). On January 1, 1968, the effective date of ABC's new four-network service, KOY disbanded the Arizona Network.

The FCC on April 24, 1968, granted a permit for KOY to relocate its transmitter and tower site to Northwest 36th Street, between Vineland Road and Southern Avenue. The move was carried out in July, 1968. In 1971, the "middle-of-the-road" music station switched to independent status; its ABC Information Network liaison ending that year.

Effective in July 1978, KOY became the property of Harte-Hanks Communications Inc. The Southern Broadcasting Company then was purchased from President John G. Johnson and Johnson family members for \$3.3 million by the publicly traded group owner, based in San Antonio, Texas. Also included in the purchase price was KQYT (FM) Phoenix; FCC approval for this transfer took place June 22. John G. Johnson was named chairman of the new licensee while Gary D. Edens became senior vice president and general manager of the Harte-Hanks Phoenix stations. L.G. Jones became president in 1979. Mr. Edens followed as president of the radio group in early March 1981, then based in Phoenix. He continued as KOY's general manager.

KOY's licensee name was changed to Harte-Hanks Radio Inc. in 1981. On April 1, 1982, the station affiliated with the NBC Radio Network, and joined NBC's "Talk-Net" for nighttime network talk programming as of February 2, 1983. Stereo broadcasting began in early 1983, using the Kahn system. R. Michael Horne became KOY station manager in early June 1983, after serving earlier as general manager of co-owned KQYT (FM). In late September 1983, Mr. Horne became Harte-Hanks vice president, while continuing as station manager of KOY and KQYT (FM).

In December 1984, KOY was acquired from Harte-Hanks Radio Inc. by Edens Broadcasting Inc. (Gary D. Edens, chairman

of the board and president) in a management buyout that included KQYT (FM) and stations in St. Petersburg, Florida, and Richmond, Virginia. R. Michael Horne rose to vice president and general manager of KOY in late January 1985. In 1987 Michael D. Osterhout was named president of Edens Broadcasting Inc. in late August, while Mr. Edens continued as owner and board chairman; the station dropped NBC's "TalkNet," and joined the ABC Entertainment Radio Network. More changes occurred during 1989. In early 1989, KOY switched to satellite-delivered programming when it added Transtar's "AM Only" adult standards music format. Its ABC Entertainment Network affiliation then was dropped as was its Kahn AM stereo transmissions. Mike Horne was transferred to an Edens-owned AM and FM property in St. Petersburg in mid-August, and Nancy L. Reynolds replaced him as vice president and general manager of KOY in mid-September. In 1991, the station joined CNN Radio as a member station.

Edens Broadcasting Inc. (Gary Denton Edens, chairman and CEO) sold KOY AM and FM for \$7 million to Sundance Broadcasting Inc. in September 1993. Sundance was headed by its president Michael Jorgenson, who then became president

and general manager of KOY. This transaction gave Phoenix its first duopoly, as Sundance was the owner of KYOT and KZON (FM) there.

Today, KOY, Arizona's second-oldest, continuously licensed AM broadcast station, operates on 550 kHz with a day power of 5,000 watts and a night power of 1,000 watts (non-directional) from studios at 840 North Central Avenue, Phoenix, Arizona. A CNN Radio affiliate, KOY airs an adult standards music format ("AM Only" from Westwood One) 24 hours a day. Licensee is Sundance Broadcasting Inc.—Michael Jorgenson, president and general manager.

Special thanks to Broadcast Pro-File, P.O. Box 982, Hollywood, CA 90078-0982. We excerpted most of the information about KOY from their lengthy reference report on the station. Broadcast Pro-File can furnish, at reasonable cost, detailed, accurate, historical reports about any American AM, FM or TV broadcast station, past or present. Many broadcasters use their services. A catalog is available from Broadcast Pro-File for \$1.

Thank you for your support of our column. We look forward to your old-time radio QSLs, photos, postcards, station listings, memories and ideas. ■

Get your hands on more bands.

Catch all the action: 800-MHz police/fire, UHF military aircraft and VHF-air, government and business bands, NOAA weather, amateur radio, TV audio and more!

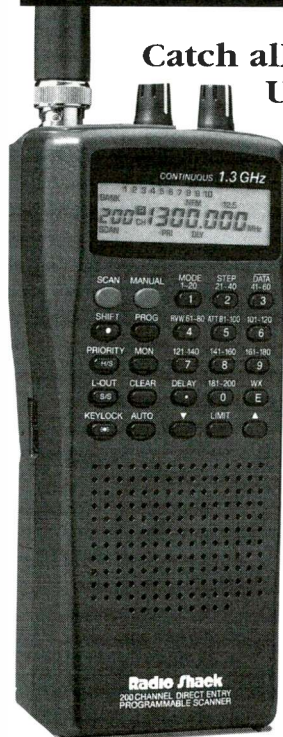

With Radio Shack's hot new PRO-26 scanner, you can monitor local action at home or listen in on exciting behind-the-scene communications at air shows, car races and sports events.

PRO-26 teams 25-1300 MHz wide band coverage and interference-rejecting triple-conversion circuitry in a rugged housing only 6⁵/₁₆" high. And it offers a host of scanning conveniences, including 300-channel-per-second HyperScan™ search and a 200-channel memory.

Grab hold of the best from America's first name in radio: the PRO-26, only from Radio Shack.

Radio Shack®

You've got questions. We've got answers.™

BOOKS YOU'LL LIKE

BY R.L. SLATTERY

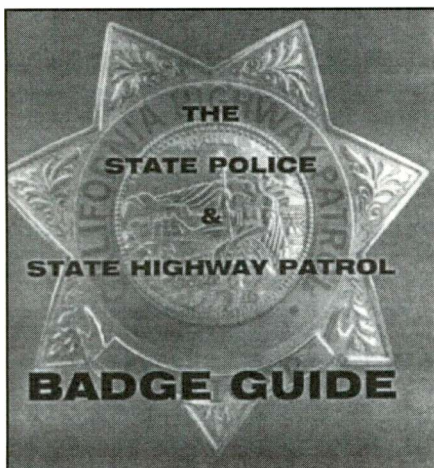

Badge of Honor

Those of us who enjoy scanning soon learn to stand in a bit more awe than the average person about the tasks faced daily by our law enforcement officers on the job. Some hobbyists eventually go into police work, or study police science. Many collect police memorabilia, such as shoulder patches, or other items.

POP'COMM columnist William Mauldin has spent years researching police badges, and is considered an authority in this field. He has written a fine, very informative new book entitled *State Police and State Highway Patrol Badge Guide*. Fully illustrated with hundreds of excellent badge photos, covering every single state, Mauldin's book devotes a page of descriptive text to each state. The text for each state describes things such as the type of coloring and design, variants in use over the years or at present, what it's made from, which company manufacturers it, whether authentic looking fakes for that state are being sold to collectors (and how to spot them), whether that state's authentic badges are available on the collectors' market, and (if so) their value on the collectors' market.

More than this, Mauldin's book has general text that discusses the terminology related to badges, and how their coded hallmarks identify the manufacturer. He tells about badge ID numbers. The book's photos are large and clear, with many shots of variant designs. Obviously, a lot of work went into this book, which offers many interesting and unusual facts.

This volume is \$12.95, plus \$3 shipping by Priority Mail, from William Mauldin Productions, Inc., P.O. Box 49944, Guilford Finance Station, Greensboro, NC 27419.

On the Right Track

The standard reference to scanning railroad communications has just been updated. It's the 13th Edition of *The*

Compendium of American Railroad Radio Frequencies. This handy 200-page information resource lists the communications frequencies used by virtually all North American railroads in their operations. This isn't a mere printout of frequencies; most are shown with specific additional information that might include type of usage, channel ID code name used, geographic locations, and whether they are base and/or mobile stations only.

These listings include specific usages such as railroad police, terminal, yard, switching, stores, portables, dispatchers, shops, towers, hump, supervisors, docks, PBX, road, maintenance of way, repeaters, general operations, etc. The information is very detailed, so you know exactly where to listen to find what you want to monitor.

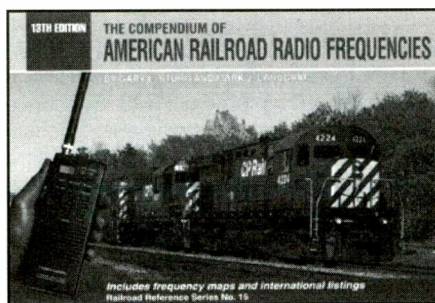

American and Canadian lines are included, as well as numerous lines in other nations. Listings cover passenger and freight railroads, as well as industrial railroads, museums and tourist railroads, transit systems and commuter authorities, and metro area systems. Some large and more important railroads are included with route maps.

This comprehensive monitoring reference guide also has lots of valuable general information explaining railroad communications, and offers suggestions about the best ways to monitor the most action. You'll learn about the frequencies and channel numbers used, the types of messages, the terminology encountered, and more—all you need to know. Lots of new frequencies have been added since the last edition, too!

The Compendium of American Railroad Radio Frequencies, 13th Edition, is \$16.95, plus \$5 shipping and handling (\$6 to Canada) from CRB Research Books, Inc., P.O. Box 56, Commack, NY 11725-0056. (NY State residents add \$1.87 tax.) VISA/MC welcomed. Toll-free phone orders: 1 (800) 656-0056. Canada/AK/HI phone orders: (516) 543-9169.

Scanner Souper-Upper

Many scanner owners look upon CRB Research Books' famous *Scanner Modifi-*

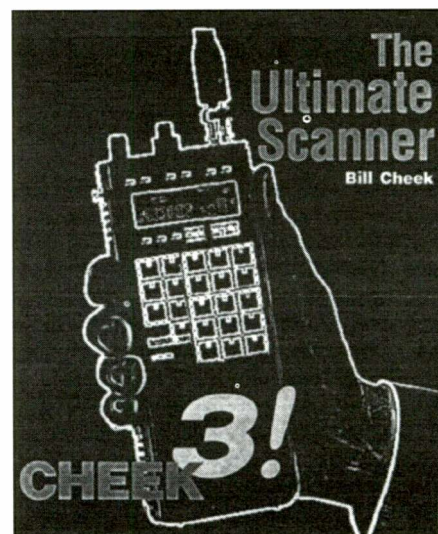

cation Handbooks, Volumes 1 and 2, by Bill Cheek, as being the most useful sources of information about enhancing scanner performance, including opening up locked-out bands, interfacing scanners with other equipment, adding S-meters, etc. Vol. 2 came out in 1991, and everyone has been wondering if and when Bill would put any more of his great modifications down on paper for the waiting world. Let's face it, there have been some new scanners, and people want to do things like open up those locked-out 800 MHz bands.

Bill Cheek's long-awaited third modification book is finally upon us. It's entitled, *The Ultimate Scanner, Vol. 3*, and seeks to begin where his first two books ended. This it does! You get to add channels, extend frequency bands, enhance sensitivity, improve control, and optimize almost everything. As usual, there are easy step-by-step instructions, and plenty of helpful photos in this big 242-page book.

Before you get too carried away, keep in mind that if you have an el-cheapo special beginner's scanner, your equipment isn't going to accept all of the mods in this book. The scanners that most often lend themselves to the best mods are the top-end, high-tech ones like the Radio Shack PRO-2004/5/6, PRO-2035, the AOR AR1000XLT, the Bearcat BC-760XLT, BC-2500XLT, etc.

Remember, in any event, no scanners manufactured after April of 1994 can be user modified to unlock the cellular bands. This includes the Radio Shack PRO-2035, for instance.

In case you're wondering, Bill's third mod book offers cellular bands unlocking data on the following scanners not previously written up in his first two books: Radio Shack PRO-37, PRO-43, PRO-39, PRO-23, PRO-51, PRO-2027, PRO-2030,

PRO-2032, Uniden older BC-890XLT, older BC-2500XLT, and BC-855XLT. "Older" means pre-1994 manufacture.

Some of the many mods covered in this book include those that can be used for various scanners (to the extent of their modifiability), such as SCA decoders, adjustable delay, RS-232 interface, computer interface, audio improvements, adjustable scan speed, autoprogram memory, auto-reject of unwanted signals, and adding more channels.

Every scanner owner interested in enhanced performance will want to have all three of Bill's excellent modification books. Cheek suggests those who modify scanners avail themselves of his three existing books because it wasn't feasible for him to attempt to cram everything into a single volume. The enormous amount of information, the numerous modifications, and the new and different models covered make all three books valuable. Cheek writes: "If scanner hacking is among your interests, you're going to have to settle in for the long haul and prepare for serial efforts."

The Ultimate Scanner, Vol. 3, by Bill Cheek, is \$29.95. You can order it from Index Publishing, at (800) 546-6707, or from leading dealers in scanner books and products. Many carry all of Cheek's modification books. ■

NEW! CAT-WHISKER

TIRED OF YOUR HANDHELD SCANNER ALWAYS FALLING OVER JUST TO KEEP THE ANTENNA "VERTICAL!"

Try our unique, swivel base, telescopic scanner antenna. Our new CAT-WHISKER lets you lay your handheld scanner on its back and still keep the antenna vertical!



- Swivels to ANY angle
- Easily adjusts to any length AND frequency
- Fits ANY scanner with a BNC antenna connector

• Fits on BACK or TOP mount scanner antenna inputs

What other antenna will let you lay your handheld on a car seat and still receive?

CAT-WHISKER #1 (5 to 23 inches).....\$19.95
 CAT-WHISKER #2 (6 to 36 inches).....\$24.95
 (plus \$2.50 S & H)

NEW!!! SCANGAT GOLD IMPROVED!

Once you use SCANGAT with YOUR radio, you'll NEVER use your radio again WITHOUT SCANGAT!

SCANGAT supports most radios by:
 AOR, DRAKE, KENWOOD, ICOM, YAESU and JRC (NRD)
 Plus PRO-2005,6 & 2035/OS456, Lowe HF-150, and Watkins-Johnson HF-1000

SCANGAT 6.0 FEATURES

- Search between any 2 frequencies.
- Search by ANY increment.
- Create Disk files.
- Import from most text formats to a working SCANGAT file.
- Log found frequencies to files while scanning.
- Scan Disk Files Frequencies.
- Spectrum Analysis to Screen OR Printer.

SCANGAT - GOLD FEATURES

We simply don't have the space to tell you ALL the new GOLD features SCANGAT-GOLD includes ALL ABOVE 6.0 FEATURES PLUS

- Link up to 15 frequency disk files.
- D-BASE IMPORT including Spectrum CD.
- Scan HF & VHF Icom's simultaneously.
- PRINT to ANY printer, or Disk File.
- Automatic BIRDIE LOCKOUT.
- Link up to 15 search banks.
- IMPORT virtually any database.
- Search by CTCSS & DCS TONES with PRO2005,6/2035 (& ICOM/DC440).
- MULTIPLE search filters.

PLUS - POWERFUL COMMERCIAL FEATURES SUCH AS:

- Demographic search for frequency co-ordination and 2-way Usage Analysis.
- Detailed logging to ASCII type files with DATE, TIME, Sig Str, Air Time
- UNLIMITED file sizes with our exclusive SCANGAT filing method.
- Exclusive "MACRO" control by frequency of Dwell, Hang, Resume.
- Sig. Threshold and even 6 separate programmable, audible alarms.
- Command line options for TIMED ON/OFF (Unattended) logging/searches.

New Supports AOR AR8000

***SCANGAT IS NOT COPY PROTECTED—USE ON AS MANY COMPUTERS AS YOU NEED* SCANGAT will run on virtually ANY 640K computer, EVEN HP-100XLT PALMTOP!**

SCANGAT comes ready to run ALL supports radios within only ONE program. SCANGAT makes your listening hobby a breeze! Plus, the included SCANPORT allows you to convert your favorite BBS, D Base or Text Files to a running SCANGAT file: 100+ Page manual included. Requires a 640K MS-DOS computer w/RS-232C serial port - hard disk recommended. Manufacturer's Interface not included. CALL or WRITE for FREE information or our \$5.00 FULLY OPERATIONAL DEMO DISK (includes shipping/handling). ORDER NOW & RECEIVE as a BONUS, FOUR SCANGAT FREQUENCY FILES!

SCANGAT GOLD	\$94.95	UPGRADE to GOLD	\$24.95
SCANGAT 6.0	\$69.95	from any version	
SQUELCH DETECT CABLES	\$24.95	PLUS \$5.00 SHIPPING & HANDLING \$7.50 FOREIGN	
OPTOScan456/535 kit	\$299 (\$10 s/h)		

Order OS456/535 & SCANGAT-GOLD combined and receive our \$15 frequency disk. **FREE!**
 Order direct or contact your favorite dealer

COMPUTER AIDED TECHNOLOGIES FREE DEMO ON BBS
 P.O. Box 18285 Shreveport, LA 71138
 Orders Only (318) 636-1234 FAX (318) 686-0449 (24 hrs) Live Tech Support (318) 687-2555 (9 a.m. - 1 p.m. Central M-F)
 Nitetime BBS (SCANGAT File Area) (318) 621-3082 (7 p.m. - 6 a.m. Central)
 Online support available on Genie, • E-mail - j.springer7@geis.com
 (See our ad on page 21 & 31)

POWER LINE NOISE, IGNITION NOISE, ATMOSPHERIC NOISE, ETC. ? JPS provides help at both ends of the receiver

ANC-4 ANTENNA NOISE CANCELLER
 Eliminates POWER LINE noise before it enters the receiver. Lets you hear signals you didn't know were there. Reduces any locally-generated noise typically by 50dB. Usable between 100 kHz and 80 MHz. Noise whip and wire antenna supplied with each unit. Requires 12 VDC @ 300 mA. Installed between antenna and receiver. List Price: \$175.00.

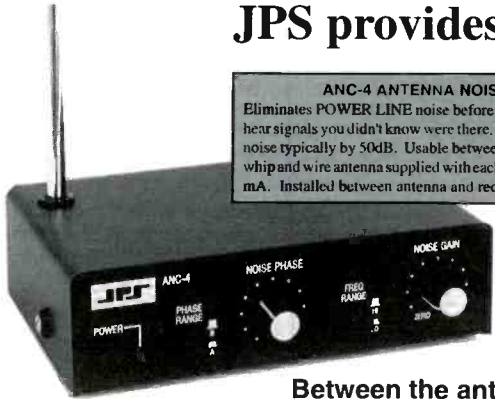

Between the antenna and the receiver

NIR-12 DUAL DSP NOISE REDUCER AND FILTER UNIT
 The most advanced DSP noise reduction unit available. Unparalleled performance: super-selective FIR filters, fully adjustable center frequency and bandwidth; both Dynamic Peaking AND Spectral Subtraction Noise Reduction; spectral multi-tone NOTCH filter. All NIR-12 modes usable simultaneously. Use on all operating modes, including AMTOR & FACTOR. Installed between receiver audio out and external speaker. List Price: \$349.95



Between the receiver and the speaker

Other fine JPS Amateur Radio products include:
 NIR-10 Noise/Interference Reducer, NRF-7 General Purpose Noise Reducer & Filter, NTR-1 Wideband Noise and Tone Remover, SSTV-1 DSP Filter for SSTV, NF-60 DSP Notch Filter, 115VAC/12VDC, 1A adapter (all units require 12V, 1A)

When you want the best, get JPS.



"First and Finest in Noise Reduction"

TOLL FREE ORDER LINE: 800-533-3819

We accept MC, VISA, Money Order, or Check (\$US)
 P.O. Box 97757, Raleigh, NC 27624
 FAX: (919)790-1456 Tech. Line: (919)790-1048
 Compuserve: 74777,3575 Internet: jps@nando.net

UNBELIEVABLE RANGE WITH A 3 INCH ANTENNA!

Hear every whisper in a room on your programmable scanner!

UHF

Model
UX-50



Check these features:

- REALISTIC 1 mile range
- Simple 5 minute assembly
- Measures only 1 3/4 x 3/4 inches
- Runs for days on low-cost 9V battery
- Single-sided board for EASY custom mounting

Only
\$79.95

WHY UHF?

Most "miniature" VHF transmitters require a 3 FOOT ANTENNA for any useful range. Our **UX-50** transmits farther with a 3 INCH ANTENNA!

UHF IS PRIVATE!

Many VHF transmitters use a cheap computer crystal to transmit on 143 MHz - receivable by EVERYONE with a 2-meter amateur radio! Our **UX-50** uses miniature transmitting crystals on one of 4 stocked frequencies away from public bands.

We back our product with a **moneyback guarantee** the "toy makers" can't match; we invite you to use our **UX-50** for a month and put it to the test. Return it for a courteous refund if it doesn't perform *exactly* as needed. **Save \$\$\$** - buy 2 or more **UX-50's** for only **\$75** each! Visa, M/C, MO, COD. Add \$3 S&H by UPS.

The leader in wireless design since 1976

DECO
Industries*

BOX 607
BEDFORD HILLS, NY
10507
914-232-3878 914-243-0346 (FAX)

GMRS

EMERGENCY Radios

- Hiking
- Fishing
- Skiing
- Camping
- Traveling
- Hunting
- Personal communications

MAXON

GMRS-210+3

2-5 Watt portable

NOW Only \$ 195.00

SM-4450

40 Watt 16 Ch mobile

NOW Only \$ 350.00

Many other accessories available for these radios: headsets, mobile antennas, speaker/mics and more.

GMRS RADIO SALES

P. O. Box 37825

Phoenix, AZ 85069

1-800-571-GMRS

Fax: (602) 878-6398

NEW PRODUCTS

REVIEW OF NEW AND INTERESTING PRODUCTS

Go Mobile With Shortwave Converter

It's been a number of years since we've seen a converter that allows you to tune in shortwave broadcasts on your car's AM radio. Imagine being snarled in freeway traffic, but tuned to the BBC. Think what it would be like going to work each morning with Radio Australia.

The new MFJ Enterprises Inc. MFJ-306 World Band Explorer Mobile Shortwave Converter will take you around the world as you tool on down the highway. When the same song is played over and over by all the local radio stations, you can bet you'll find something interesting to listen to on shortwave—all without the expense of buying a new radio for your car. The shortwave con-



JPS Communications Inc.'s NIR-12 Noise and Interference Reducer.

The NIR-12 uses dual Digital Signal Processors (DSP) to provide simultaneous bandpass operation, noise reduction and multiple tone removal. The spectral notch filter eliminates multiple tone interference from "tune-ups," foreign broadcast carriers, CW, RTTY and more. A multilayer printed circuit board provides superior shielding to virtually eliminate radiation from the DSP data bus. Two methods of noise reduction are provided: Improved Spectral Subtraction (NIR) and Improved Dynamic Peaking, to give the operator the best audio noise reduction possible.

For experimenters, access to the dual DSPs is provided via RS-232 on an internal header. The unit's manual describes this implementation.

The Improved NIR mode of noise reduction automatically enhances voice, CW or data signals by recognizing the speech, CW or data and reducing the amplitude of all signals that are not part of the desired information. In addition to providing a continuously variable processing level, the NIR control features an automatic position to give the optimum noise reduction based on the measured signal-to-noise ratio.

The Improved Dynamic Peaking noise reduction features an external Peak Factor switch to allow the operator to control the "aggressiveness" of the peak mode. When this mode is used in conjunction with the NIR mode, exceptional noise reduction can be attained without damaging speech components or intelligibility.

All modes in the NIR-12, except the NIR mode, operate in "real time" with very small delay, so the unit may be used in all data modes, including ARQ modes popular with AMTOR and PACTOR. The Finite Impulse Response (FIR) filters provided in the unit have very steep skirt selectivity, linear phase in the passband and minimum passband ripple, all desirable characteristics for good data and SSTV reproduction. The bandwidth of the filter is variable from 50 Hz to 3200 Hz and the center frequency of the chosen filter is variable from 200 Hz to 3400 Hz. The combination of variable filter bandwidth and variable center frequency provides user-friendly operation.

Installation of the NIR-12 is simple: The unit gets audio input from the receiver's speaker output line or headphone jack and then provides volume-adjustable processed

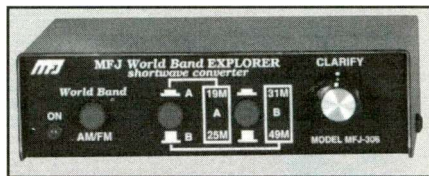

The MFJ-306 World Band Explorer shortwave converter.

verter is easy to install: You unplug the antenna from your car radio and plug it into the MFJ-306. Then, plug the cable from the converter into your car radio. Connect the 12-volt cord and voila! You're tuning the 19-, 25-, 31- and 49- meter shortwave broadcast bands with the flick of a switch.

The MFJ-306 measures 5 by 1.5 by 3.5 inches and fits handily in tight spaces. The converter works with all car radios, including the digital versions already preset at 10-kilohertz spacing. A clarifier knob on the front of the converter allows you to zero in shortwave stations that would be sandwiched between those 10 kHz steps on newer car radios. You wouldn't find this feature on older versions of converters because of the old analog AM radio dials. And when you want to return from the world bands to the local stations, a simple push of a button is all it takes.

The MFJ-306 carries MFJ's one-year unconditional guarantee. The unit carries a suggested price of \$79.95. For more information, contact any MFJ dealer or MFJ Enterprises Inc., P.O. Box 494, Mississippi

Shhh! Be Very Quiet

JPS Communications Inc. has introduced its advanced DSP noise reduction and filter unit available to amateur radio operators and shortwave listeners. The NIR-12 Noise and Interference Reducer and Filter Unit is a state-of-the-art audio signal processor designed to provide the user with maximum flexibility to reduce or eliminate most types of interference from received voice, CW and data transmissions.

audio from its own built-in amplifier to power an external speaker of 3- to 8-ohm impedance. A line output, which is unaffected by the volume control, is provided for modem or phone patch.

The NIR-12 requires 12 volts DC at 1-amp peak. Power adapters are available from JPS at nominal cost. Mating connectors are supplied with each unit. The NIR-12 carries a one-year factory warranty and is fully upgradable. Contact: JPS Communications Inc., P.O. Box 97757, Raleigh NC 27624-7757, (919) 790-1011, or e-mail via the Internet at jps@nando.net.

Signs and Decals

One problem facing radio clubs—ham and listener—is that when you want to have a banner or decals made for your club, the cost often is quite prohibitive. It seems everyone wants your money for a product that may be used only a few times a year.

Old West Graphics of Fort Collins, Colorado, now produces custom graphic decals and other related products for radio enthusiasts and clubs. According to the folks at Old West Graphics, the trend in computer software in the past decade has made it possible for even clubs with a small num-

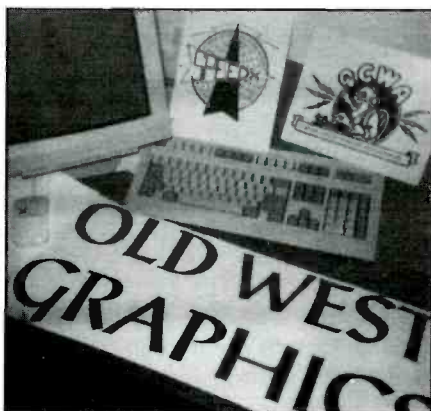

Let Old West Graphics produce decals for your radio club.

ber of members to have their club logo designed professionally for use as a window decal, applied to T-shirts and sweatshirts, to include it on a club banner, or wherever else looks sharp.

Old West Graphics will take your club's logo and computer-generate it as a professionally produced logo, whether you want one copy or a thousand. And those clubs without a logo need not fret: Old West Graphics will help you get one designed.

In addition to logo decals, Old West Graphics now is making available to the radio enthusiast computer-cut lettering, convention and hamfest banners, ham radio license plates and novelty street signs for your driveway (can you imagine N2DUP Boulevard?).

For more information and pricing on the products produced by the firm, contact: Old West Graphics, 749 S. Lemay, Suite A3-355, Fort Collins CO 80524-3251, or (800) 579-0959.

FREE SAMPLE COPY!

ANTIQUE RADIO CLASSIFIED

Antique Radio's Largest-Circulation Monthly Magazine

Articles - Classifieds - Ads for Parts & Services
Also: Early TV, Ham Equip., Books, Telegraph, 40's & 50's Radios & more...
Free 20-word ad each month. Don't miss out!

1-Year: \$34.95 (\$51.95 by 1st Class)
6-Month Trial - \$17.95. Foreign - Write.

A.R.C., P.O. Box 802-T10, Carlisle, MA 01741

Or Call: (508) 371-0512

PORTABLE SATELLITE ANTENNA

Complete 2' KU Band System

For **FREE** information package and pricing

• Call 219-236-5776 •

R.C. Distributing Company - PO Box 552 - South Bend, IN 46624

CIRCLE 72 ON READER SERVICE CARD



World's Most Powerful CB and Amateur Mobile Antenna*

Lockheed Corp. Test Shows
Wilson 1000 CB Antenna Has
**58% More Gain Than The
K40 Antenna (on channel 40).**

In tests conducted by Lockheed Corporation, one of the world's largest Aerospace Companies, at their Rye Canyon Laboratory and Antenna Test Range, the Wilson 1000 was found to have 58% more power gain than the K40 Electronics Company, K40 CB Antenna. This means that the Wilson 1000 gives you 58% more gain on both transmit and receive. Now you can instantly increase your operating range by using a Wilson 1000.

Guaranteed To Transmit and Receive Farther Than Any Other Mobile CB Antenna or Your Money Back**

New Design

The Wilson 1000 higher gain performance is a result of new design developments that bring you the most powerful CB base loaded antenna available.

Why Wilson 1000 Performs Better

Many CB antennas lose more than 50% of the power put into them. The power is wasted as heat loss in the plastic inside the coil form and not radiated as radio waves.

We have designed a new coil form which suspends the coil in air and still retains the rigidity needed for support. This new design eliminates 95% of the dielectric losses. We feel that this new design is so unique that we have filed a patent application on it.

In addition, we use 10 Ga. silver plated wire to reduce resistive losses to a minimum.

In order to handle higher power for amateur use, we used the more efficient direct coupling method of matching, rather than the lossy capacitor coupling. With this method the Wilson 1000 will handle 3000 watts of power.

The Best You Can Buy

So far you have read about why the Wilson 1000 performs better, but it is also one of the most rugged antennas you can buy. It is made from high impact thermoplastics with ultraviolet protection. The threaded body mount and coil threads are stainless steel; the whip is tapered 17-7 ph. stainless steel. All of these reasons are why it is the best CB antenna on the market today, and we guarantee to you that it will outperform any CB antenna (K40, Formula 1, you name it) or your money back!

*Inductively base loaded antennas
**Call for details.

Lockheed - California Company

A Division of Lockheed Corporation
Burbank, California 91520

Aug. 21, 1987

Wilson Antenna Company Inc.
3 Sunset Way Unit A-10
Green Valley Commerce Center
Henderson, Nevada 89015

Subject: Comparative Gain Testing of Citizen's Band Antennas
Ref: Rye Canyon Antenna Lab File #970529

We have completed relative gain measurements of your model 1000 antenna using the K-40 antenna as the reference. The test was conducted with the antennas mounted on a 16' ground plane with a separation of greater than 300' between the transmit and test antennas. The antennas were tuned by the standard VSWR method. The results of the test are tabulated below:

FREQUENCY (MHZ)	RELATIVE GAIN (dB)	RELATIVE POWER GAIN (%)
26.965	1.30	35
27.015	1.30	35
27.065	1.45	40
27.115	1.60	45
27.165	1.50	41
27.215	1.60	45
27.265	1.75	50
27.315	1.95	57
27.365	2.00	58
27.405	2.00	58

58% MORE POWER GAIN THAN THE K40

Individual test results may vary upon actual use.

CALL TODAY

TOLL FREE: 1-800-541-6116
FOR YOUR NEAREST DEALER

Wilson 1000

DEALERS Exclusive dealer areas still open

Roof Top Mount.....	59 ⁹⁵
Trunk Lip Mount.....	69 ⁹⁵
Magnetic Mount.....	79 ⁹⁵
Little Wil.....	29 ⁹⁵
Wilson 2000 Trucker.....	59 ⁹⁵

Wilson

ANTENNA INC.

1181 GRIER DR., STE A
LAS VEGAS, NV 89119

Phone Patch?

The *Patch Antenna* is a new cellphone product that promises to make portable cellphones more practical and efficient. Incorporating a distinctive combination of revolutionary design and advanced technology, the antenna features patented circuitry the manufacturer claims will "amplify, boost and purify a cellular signal, greatly improving reception and transmission."

This device, offered by International Cellular Communications of Agoura Hills, Calif., is designed on a four-inch square. A static-cling coating allows it to adhere to any glass surface. Conductive etched copper lines are embedded within the epoxy patch. The manufacturer claims the design increases the signal strength by up to 10 times, and that most portable cellphone users experience an average 30 percent improvement with the device when used with any make or model portable cellphone. They can be tuned anywhere from 700 MHz to 1 GHz.

We haven't seen or tried one of these, but the literature the company sent along certainly makes the device look very promising. The suggested retail price is less than \$30. Want more information? Contact International Cellular Communications Inc.,

28030 Dorothy Drive, Suite 301, Agoura Hills, CA 91301. Phone (800) 997-2824, or (818) 706-9985. Mention you read about it in *Popular Communications*.

900 MHz Cordless, Plus PBX

The Uniden PHP-9000 has a 900 MHz digital PBX cordless handset that is compatible with most PBX and key systems. Multichannel auto-scan monitors multiple channels and automatically selects the best channels to assure the best quality transmissions. The 900 MHz digital scrambling ensures privacy, the impedance interface allows the units to operate on various PBX/key system equipment. The PHP-9000 also has Digital Security Coding that prevents other handsets from accessing the base unit.

This unit is from Uniden America Corp., 4700 Amnon Carter Blvd., Fort Worth, TX 76155. Phone (818) 858-3300.

Personal Intelligent Communicator

Panasonic's new Personal Intelligent

Communicator (PIC) can send and receive e-mail, phone calls and faxes. It also creates messages, takes notes, plans schedules, files or deletes documents, moves notes from one area to another, and plays games.

Depending upon subscription services, the unit also can read a daily newspaper, check stocks or do shopping. AT&T *PersonaLink Services* are built in. With future PCMCIA application cards, the potential uses for the device seem limitless.

This is a lightweight, compact unit operated with an attached or stand-alone stylus. Just touch an easily recognized desired icon, file name, menu option or graphic to advance to the next step. Touch the stylus to the screen and slide it to move an object from one place to another. The stylus can be used for handwritten notes or messages, with several different "pen" types available. Additionally, an on-screen standard keyboard facilitates typing, including the typewriter sound effects.

This device is designed to be user-friendly to everyone, even those who are normally put off by technology. Anybody can use it. The Magic Cap software was designed to be simple, even fun to use.



No, it's not the latest commemorative stamp from one of the former Soviet republics. It's a new advanced cellular antenna ◀ you'll want to know about from our column this month.

The Uniden PHP-9000 PBX cordless handset utilizes 900 MHz band technologies.▼





Panasonic's Personal Intelligent Communicator has a lot to offer, and promises to be user-friendly to everyone. It sends and receives e-mail, cellphone calls and faxes. You also can use it to do office chores and play games!

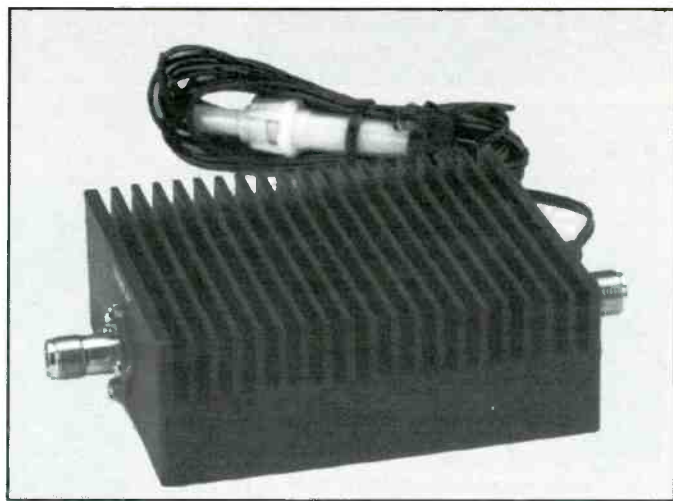

The ORA Signal Booster amplifier aids received and transmitted signals from portable cellphones used in vehicles.

The Panasonic Personal Intelligent Communicator has two megabytes of RAM, plus 1/2-megabyte of reserve memory. The screen measures about 3 by 4.5 inches, and boasts 480 (V) by 320 (H) lines of resolution. It operates from four "AA" alkalines. It weighs about 1 pound, with batteries.

This comes from Panasonic, Matsushita Consumer Electronics Co., One Panasonic Way, Secaucus, NJ 07094.

Booster

Remember CB footwarmers? ORA Electronics offers the new Booster Amplifier Model SB-2000, being a power amplifier for portable cellphones used inside a vehicle. The in-line booster turns a 0.6-watt portable cellphone signal into one that equals that of a full three-watt carphone. This is fully legal.

The ORA unit boosts both the transmit-

ted and received signals of a cellular call, and is suggested for users who complain about poor reception or dropped calls because of low signals or in areas with marginal cellular coverage. The manufacturer reports the booster provides improved range and cellular system access, markedly improving the signals of portable cellphones used in vehicles.

The small FCC-approved unit fits neat-

NEW!

COPYCAT-PRO

IMPROVED!

The **ONLY** Commercially Available
Computer Control Program
for the Universal M-7000 & M-8000.
AEA's PK-232 and the MFJ-1278 ...

... JUST GOT BETTER!



STANDARD COPYCAT FEATURES

- 32K incoming text buffer
- Runs on any 640K PC Compatible
- Pull down menus
- 50 page printed manual
- Mouse support (but not required)
- New improved online help
- 20+ programmable macros

Note: Std. COPYCAT Does Not Support Radio Interface

NEW COPYCAT-PRO FEATURES

- Control **BOTH** your TNC and radio simultaneously! Send commands to TNC and at same time, send frequency and mode to radio!
- Supports ALL SCANCAT frequency file formats, or create your own!
- NEW! Multiple pop-up windows for HELP, frequency files, and text editor. Instantly go between any of three windows with single keystrokes.
- NEW, easier, "Plain English" MACRO language for control of all radio and TNC functions.
- RADIO SUPPORT for most AOR, KENWOOD, JRC, ICOM, YAESU, plus LOWE's HF-150 and Watkins Johnson's HF-1000.

Discover our revolutionary COMPUTER CONTROL PROGRAM for the M-7000 and M-8000. Let COPYCAT free you FOREVER from remembering all those buttons and keys. COPYCAT does it all! Simple "PULL-DOWN" menus control all functions. No more looking through complicated manuals or searching for buttons. ALL commands are in plain English. *PLUS* COPYCAT has a fully editable text buffer, with cut & paste. Save/load/edit/print files. PROGRAMMABLE macros and much more. COPYCAT supports ALL the above units within ONE program. Simply select your units from COPYCAT's EASY-TO-USE menu and GO!

COPYCAT-PRO \$79.95 COPYCAT (std) \$59.95
upgrades to COPYCAT-PRO \$24.95

S/H \$5.00 (\$7.50 Foreign)

(Be sure and order our serial adapter if you do not have the specially wired cable for the M-7000/8000)
SERIAL CABLE ADAPTERS FOR M-7000 AND M-8000 \$24.95.

COMPUTER AIDED TECHNOLOGIES

P.O. Box 18285 Shreveport, LA 71138

Orders Only (318) 636-1234 - FAX (318) 686-0449 (24 hrs)

Live Tech Support - (318) 687-2555 (9 a.m. - 1 p.m. Central M-F)

NiteTime BBS (SCANCAT File Area) (318) 631-3082 (7 p.m. - 6 a.m. Central)

Online support available on GEnie. • E-mail - j.springer7@geis.com

(See ad on page 21 & 27)



Order direct or contact your favorite dealer

UNLOCK

FULL 800 MHz

CLASSIC SCANNERS

PRO 34,37,39,43,46,2004,5,6
2022,26,27,30,32

BC 200,205,2500,700,760
855,890,950

Over 1500 Satisfied Customers

Same Day Service...

FREE Insured UPS Return

FOR DETAILS CALL:

508-281-8892

SHIP TO:

Cellular Security Group

47 Causeway Street

Gloucester, MA 01930

ONLY the "classic scanners" listed above can be unlocked and some are restricted by the date of manufacture.

Note: Certain modifications may be in violation of F.C.C. rules and regulations. Cellular Security Group assumes no further responsibilities beyond those stated in this ad.

\$40

FREE CELLULAR FREQUENCY CHARTS



GMRS Radios & Accessories



We have the lowest advertised price on the hot new repeater capable, MAXON GMRS-210+3 PORTABLE

NOW ONLY \$198.95!

Many accessories are available for this radio:

- 4 watt battery
- Fast dest top charger
- VOX headsets
- Mobile 5db gain antennas to increase range.
- Speaker/mikes & more

MAXON GMRS-210+3 10 ch. 2-5 watt. \$198.95

We also have the lowest prices on VHF & UHF business radios and equipt. Many models of ICOM & YAESU HT's & mobiles in stock. **COD orders are welcome! We have the lowest shipping rates!**

Shipping info: Orders shipped in 24 hours with cert. ck. or money order. COD's shipped via UPS in 24 hours. \$5.50 for pkgs. to 1lbs, \$8.50 to 3lbs

Sports-Communications Dist.

P.O. Box 36, Scotts Mills, OR 97375
Orders only call: (800) 573-2256
info only call: (503) 873-2256
fax: (503) 873-2051

CIRCLE 162 ON READER SERVICE CARD

SHORTWAVE SALE

Tremendous savings on Sangeans top of the line digital shortwave receivers.

ATS 818CS PLL synthesized, dual conversion. AM-FM-SW digital receiver with programmable cassette recorder 45 memory presets, and 150 - 29999 KHz continuous coverage w/BFO for SSB **\$209.00**

ATS 818 Same as ATS-818CS but w/o cassette recorder **\$149.00**

ATS 808 PLL synthesized, dual conversion. AM-FM-SW digital receiver 45 memory presets, 150 - 29999 KHz continuous coverage, 3 in speaker, and local/DX selector **\$135.00**

ATS 806P Ultra-compact, PLL synthesized, dual conversion. AM-FM-SW digital travel receiver 45 memory presets, 150 - 29999 KHz continuous coverage Comes w/pocket antenna. **\$145.00**

All receivers come with AC adapter, full numeric keypad for direct frequency entry, auto-scan, dual local/UTC time display, sleep/timer alarm functions, and a full 1 yr. warranty. Models ATS-818/CS, ATS-808 have tricolor digital displays. Add \$5.00 for shipping. CA Residents please remit Sales Tax.

Toll Free 1-800-717-7780

At these great prices now is the time to buy a full featured Sangean digital shortwave receiver.



CHILTON PACIFIC LTD.
5632 Van Nuys Blvd., #222
Van Nuys, California 91401

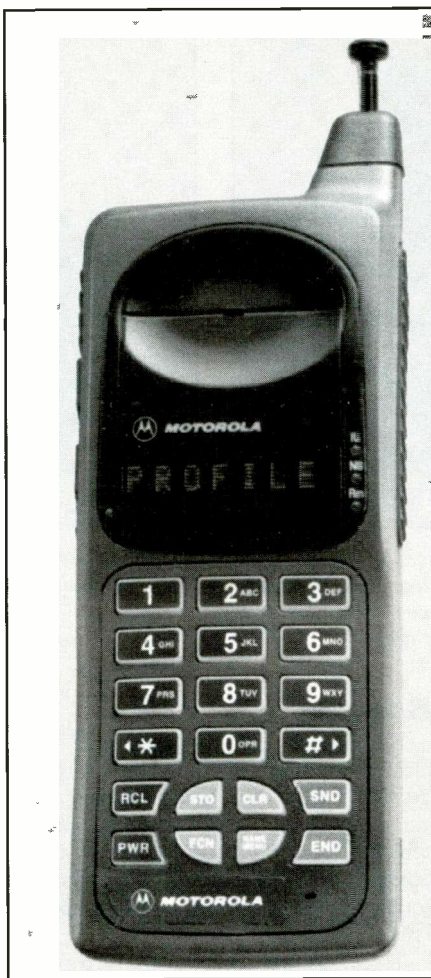

Motorola's new Profile 4000 pocket cellphone operates in digital and analog modes.



The EZ Pager is an easy-to-use, basic unit. Despite its low cost, it offers numerous useful features.

ly under a car seat or in the trunk. It is compatible with any portable phone and can be easily installed in-line between the portable phone and its external antenna.

This sells for less than \$400. For more

information, contact ORA Electronics, 9410 Owensmouth Ave., Chatsworth, CA 91313. Phone (818) 772-2700.

Digital in Your Pocket

Motorola's new Profile 4000 dual-mode analog and TDMA digital pocket cellphone is a tiny fistful of technology. It weighs less than 10 ounces, looks really good, and overflows with user-friendly features.

Using a standard XT battery, you get up to an hour of talk time, or six hours of stand-by. The unit is designed to take advantage of advanced digital features as they become available in local areas offering TDMA service, including: message waiting indicator; calling line ID; authentication; voice encryption; and distinctive ringing.

Besides a unique new look, the Profile 4000 has useful features such as one-touch turbo/emergency dialing; alpha memory storage, credit card dialing, and numerous optional accessories, including a hands-free vehicle kit, modems, several battery chargers, and other items and services.

This cellphone is designed to meet the TIA IS-54 standard for North American TDMA digital cellular service, and keep in mind that it also will operate in regular analog cellular mode in those areas where a TDMA digital channel is not available. More than 50 cellular U.S. markets now offer digital cellphone service in addition to analog service.

For further information on Motorola's Profile 4000, call Motorola's Cellular Information Center at (800) 331-6456.

An Easy Page

The new Vanguard EZ synthesized pager is being introduced by Panasonic and VCP International. This is a low-cost, simple-feature model designed for users seeking a basic, easy-to-use pager.

Features include flexible memory with up to 11 messages, elapsed time clock, individual message delete, unread message reminder alert, single-button operation, and back-lighted display. Its baud rate and frequency also are programmable.

This one-channel, fully synthesized pager is available in black, blue, clear, rose, smoke gray and teal. The pager is now available for VHF operation, with UHF and 900 MHz models to follow soon.

VCP International's mailing address is P.O. Box 550999, Dallas, TX 75355-0999. For more information about this pager, phone VCP International at (800) 442-7001. They said to be sure to tell them you read about their EZ Pager in *Popular Communications*.

Please pass along news clippings, questions, news releases and product releases relating to cellphones, cordless units, pagers and other personal comms devices. ■

HOW I GOT STARTED



Meet Hernan Hidalgo, N3OKP—a true shortwave listener can never have enough equipment!

Popular Communications invites readers to submit in approximately 150 words how they got started in the communications hobby. They preferably should be type-written, or otherwise easily readable. If possible, your photo should be included.

Each month we will select one entry and publish it here. You need submit your entry only once; we'll keep it on file. All submissions become the property of Popular Communications, and none can be acknowledged or returned. Entries will be selected for use taking into consideration if the story they relate is especially interesting, unusual, or even humorous. We reserve the right to edit all material for length and grammar, and to improve style.

The person whose entry is selected will receive a one-year gift subscription (or one-year subscription extension) to Popular Communications.

Address all entries to: How I Got Started, Popular Communications, 76 N. Broadway, Hicksville, NY 11801.

Our September Winner

This month's winner, Hernan Hidalgo, of Kensington, MD, has spent the last ten years enjoying the shortwave listening hobby. Here is his story:

"I have been a scanner buff since the age of nine, when my friend Jason (N3PRZ) first introduced me to the shortwave listening hobby. Now at 19 years old, I have since drafted the aid of several directories and guides with which I have monitored everything from the nearby shopping mall to the aircraft flying in the sky.

"My town's fire department knows my friends and me very well—thanks to our



The "Control Tower" is where all the listening action becomes reality for Hernan and his friends.

scanners we always show up at all major incidents from building fires to jackknifed tractor-trailers, using our bicycles as vehicles!

"I have a 46-foot-high treehouse in my backyard that we call 'The Control Tower.' Often my friends and I spend the night in it for an evening of scanning. We each bring up all of our equipment, including portable and tabletop scanners, shortwave radios, CB radios, two-meter rigs, portable telephones, etc.

"My buddies and I look forward to the future when we'll have our own cars for real mobile communications. Until then, our bicycle-mounted radios will do the trick!" ■

It's time you found out...
What over 185,000
people already know.

NOW YOU'RE TALKING!

was written with you, the reader, in mind.

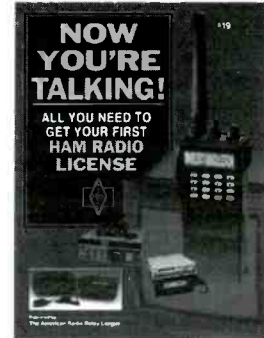

There's never been a more exciting time to get your Ham license. You can use Amateur Radio as a fun, friendly method of local communication, an invaluable tool in emergencies, or even experience the thrill of talking to Astronauts and Cosmonauts in orbit.

Whether you want to enter Amateur Radio as a Technician and choose to skip the code, or as a Novice licensee, *Now You're Talking* will provide you with the information you need in bite-size, easy-to-understand diagrams, photos and sketches, you'll be familiar with all the questions used to make up the FCC test...and you'll be ready for it.

In addition to study material that won't let you down, you'll find invaluable operating hints and tips you'll use once you pass your test. *Now You're Talking: All You Need to Get Your First Ham License* is the book you'll use even after you've passed your exam.

You can shop around for bargains, or you can join the thousands of licensed amateurs who have used *Now You're Talking* to pass their exam. Order your copy today:

Enclosed is \$19 plus \$4 for shipping (a total of \$23) or charge \$23 to my
() VISA () Mastercard
() Discover () American Express

For more information Call
1-800-326-3942

Signature _____

Acct. No. _____

Expiration Date _____

Name _____

Address _____

City _____ State _____ Zip _____ PC

THE AMERICAN RADIO RELAY LEAGUE
225 MAIN STREET
NEWINGTON, CT 06111

CLANDESTINE COMMUNIQUE

WHAT'S NEW WITH THE CLANDESTINES

Time again to step into broadcasting's dark regions to explore the world of clandestine radio.

The Angolan clandestine Voice of the Resistance of the Black Cockerel (VORGAN) is now operating on 5890, signing on at 0500. This station sometimes is well heard in North America; this particular time/frequency combo should be a good pair for reception. The station's programs are in Portuguese and local languages.

Radio For Peace International still carries the "Focus on Haiti" program—Tuesdays at 2030 and Saturdays at 2100 on 6200, 7385 (from 2100), 9400 USB and 15050. With all the media furor being raised about rightwing broadcasts, check out RFPI's "Far Right Radio Review" Sundays at 2200 and Tuesdays at 1800.

The Voice of Oromo Liberation, airs on WHRI, Indiana, and says it is broadcasting on behalf of the Oromo Liberation Front. The broadcasts consist of short commentaries, patriotic Oromo songs, and messages condemning the current government of Ethiopia. Listen at 1900-2000 on Tuesdays, Fridays and Sundays.

Another Ethiopian clandestine, the Voice of the Tigre Revolution, operates from Makale, the capital of Ethiopia's Tigre Province. It signs on at 0356, and is heard on 7515, with an opening ID in Tigre at 0400. A few DXers in the eastern part of North America have picked this one up.



The Voice of Democratic Burma, aired over the facilities of Radio Norway, says it now is using 7315. It's unclear whether this replaces or is an addition to the usual 11850 frequency. These programs, in Burmese, are aired at 1430. The Democratic Voice of Burma issues an attractive QSL card for correct reports sent to Maung Maung Myint, Democratic Voice of Burma, P.O. Box 6720, St. Olavs Plass, N-0130 Oslo, Norway.

Radio Rebelde of the "Government in Transition in Rebellion," claims to be operating as a mobile station from Chiapas province, Mexico. It is appealing for help—apparently in the form of equipment—via its support organization, the National Commission for Democracy in Mexico, USA, headquartered at 601 North Cotton, Suite A-103, El Paso, TX. This station appears to be affiliated with two others—La Voz de Chiapas Libre and La Voz de Guatemala Mayan. However,

La Voz Popular

The Voice of the People

An Alternative Radio Station
Official radio of the Guatemalan National Revolutionary Unity (URNG)

Guatemalan clandestine La Voz Popular operates from inside Guatemala with a regular schedule and about a kilowatt of power, but seldom is reported in North America.

none of the three stations have been very active or, to our knowledge, been heard very far outside their operational areas probably because of the use of extremely low power. If these stations ever use enough power to be heard widely, they'll certainly be interesting targets. The

Rebelde station may use a frequency between 7410-7420 or 7460-7470.

It's odd that there are so few reports of longtime Guatemalan clandestine La Voz Popular, which has a regular schedule and enough power to make its way into some of the receiver/antenna combinations of better-equipped DXers in North America. Check for this one. Let us know what you find. It's scheduled Tuesdays and Fridays at 2300-0000. Probe the area between 6965 and 7035. The station will hop around a bit, trying to avoid Guatemalan jamming. It is believed to be running about a kilowatt.

News reports indicate that plans continue to develop for broadcasts by Radio Free Kenya, which is to be operated by opposition political parties. If things go according to plan, the station could even be on the air now, although it's still not known whether the station will use medium wave, shortwave, or both. First reports indicated the station would be on board a ship off the Kenyan coast but the latest info refers to a "strategic location" and implies a land-based operation.

Radio Free Bougainville (Bougainville Island, Papua New Guinea) is reported still active on 3850, although on an erratic schedule (around 0930), using very low power. The government's counter station, Radio United Bougainville, still broadcasts on 3880 during the same time frame. The Solomon Islands Broadcasting Station on 5020 is reported to be suffering from occasional jamming believed to be coming from Papua New Guinea.

The Voice of Free Sahara (La Voix du Sahara Libre) operated by the Polisario Front, still is being carried via Radio Algeria at 2200 on 9640 and 15215. Another Polisario operation, National Radio of the Sahara Arab Democratic Republic continues to operate on 11800 from 1800 to 0000 and 0600-0900, in Arabic. Reports for either of these broadcasts may be sent to: Directeur d'Information, Polisario Front, B.P. 10, El-Mouradia, Algiers, Algeria.

Your clandestine log reports, QSL details and other news and information about clandestine or semi-clandestine broadcasters are always welcome. We look forward to hearing from you as often as you are able to check in.

Until next month—good hunting! ■

HF 150 IBS★★★★

**REAL RADIO, RUGGED,
RELIABLE**

Simplicity makes the HF150 easy to operate, and the synchronous detection produces superb audio which enhances the outstanding performance!

- Frequency: 30kHz - 30MHz
- Multimode: AM, AMN, LSB, USB
- 60 Memories (FREQ. & MODE)
- Tuning Step: 8Hz
- Bandwidth 7kHz & 2.5kHz
- 3 Ant. inputs, 600 Ohm BAL, 50 Ohm Coax and high impedance whip
- Built In Speaker, Ext. Jack & Record OUT
- Power 10-15VDC .15A (.3A max)
- Includes FREE AC adaptor
- Size: 7.3"W x 3.2"H x 6.3"D; 2.9 lbs.

**New for the
LOWE HF150
Display Back-
Light kit for
LCD readout.**

*The BL150 is easily
installed, instructions
included.*



LOWE



SP150

**New.... Just Released!
The Ultimate
Lowe Accessory!**

The latest from Lowe is a combination audio filter, amplifier and speaker. Works well with any SW receiver or transceiver, but designed to compliment the HF150 and PR150.

Features:

- 10W Audio amplifier
- Variable notch filter
- High pass filter
- Low pass filter
- Built-in loudspeaker
- External speaker output
- Headphone output



*The SP 150, PR 150 and the HF 150 shown
pictured on the three tier rack system.*

PR150

Pre - Selector w/ Pre-Amplifier

While a perfect match to the HF 150, this excellent unit is very effective with other SW receivers. Lowe's recently revamped model obtains wide coverage of 100KHz to 30MHz through the use of seven tunable bandpass filters. Multiple antenna inputs, pre-amp attenuator and much more. Hear what you've been missing by eliminating intermod & image interference.

Antenna input: 50ohm unbalanced, 600ohm balanced • **Power:** 10 - 15VDC

Size: 7.3"w x 3.2"H x 6.3"D



WRTVH RECEIVER OF THE YEAR!

HF 225 IBS★★★★

Rated 4 stars by Passport's Larry Magne,

- Multimode, AM, SSB, CW
- 30 Memory Channels
- Optional AM Synchro & FM
- Filter for all Modes: 2.2, 4.7, 10kHz 200Hz audio CW filter
- Built-In Speaker, Ext. Speaker, Rec. Jacks
- 10-15VDC .15A (.3A MAX) AC/Nicads Opt.
- Size 10"W x 4.2"H x 8"D; 4.18 lbs.



HF 225E EUROPA

A "Turbocharged" HF225 for the dedicated DXer! Same high performance features of the HF225 plus these additional features:

- 7, 4.5 & 3.5kHz replacement filters for excellent selectivity
- Reduced residual noise thru shielded coils and switching diodes
- Synchronous detector (D225) & KPAD1 standard on Europa version

CALL, FAX OR WRITE FOR DETAILED FLYER!

HF 235 THE PROFESSIONAL CHOICE

Top of the line rack version of the HF225, with similar specs. A professional communications receiver for the discriminating user, with high stability OSC & opt. computer RS232.

ACARS FROM LOWE....The Air Master!

The Lowe Air Master is a super combination of hardware and software for the receiving and decoding of ACARS (Aircraft Communications Addressing and Reporting System). This is a new teletype message format used to transmit data between commercial aircraft and airport ground stations. ACARS was developed and implemented to reduce the work load of flight crews by using computers to handle routine communications. This information is transferred via VHF to the ACARS ground station. Generally speaking, if your customer is able to receive VHF voice transmission, then ACARS traffic should be no problem from the same source. When using the Air Master software with your PC and an air-band receiver, you'll be able to view the ACARS messages as they are received. The package includes the MS-DOS software for use with a 386 or higher PC, the computer interface and manual. The interest level in this market is growing rapidly. Be sure to get a demo or evaluation unit for your store. Look for upcoming product reviews and new product releases.

Two or three tier rack mounts, along with a variety of accessories are also available from EDCO. Keypads for the HF150 and HF225, Carrying Cases, Mounting Brackets, and a Computer Control Interface are just a few of the extras which can give you optimum performance of your LOWE product. Contact EDCO for full details.



**Electronic Distributors Co.
P.O. Box 1936 • Vienna • VA 22180
Ph 703 • 938 • 8105 FAX 703 • 938 • 4525
Contact your favorite Dealer today!**



SCANNING VHF/UHF

BY CHUCK GYSI, N2DUP

MONITORING THE 30 TO 900 MHz "ACTION" BANDS

Some of the best scanning can take place during the fall months. It's not too hot, and folks still are active outside. Fall sports are under way and can be monitored if you bring a scanner. If you head to a school-related event such as a marching band competition, be sure to check business frequencies that may be in use on the field, especially the itinerant-use frequencies of 151.625, 464.500 and 464.550 MHz.

Frequencies used by school buses, which were quiet all summer, all of a sudden are active in both the special emergency radio service in the 155-MHz band, as well as business frequencies in the 151, 154 and 461-465 MHz bands. If the school district in your community didn't have radios in its buses last year, be sure to check for antennas on the vehicles this fall. Many school districts will install radios in its buses over the summer months so it is less disruptive to transportation operations.

And when you find new and interesting frequencies, don't forget to let us know at POP'COMM so we can tell others of your finds, too!

Blast Freqs

Dick Sharp, who lives in Oklahoma City, Oklahoma, sent us some e-mail right after the massive blast that rocked his city earlier this year. Dick was quick to pass along his list of active frequencies in use during the immediate days after the explosion tore into the federal building there. Here's the report Dick sent to POP'COMM:

"With a cup of coffee and the daily paper, I sat down at my monitoring post to see what was happening in the world as well as locally. On April 19, at 9:02 a.m., the Central Division (Will Rogers) frequency (for Oklahoma City police) came alive with frantic calls about an explosion downtown. Almost three seconds later, a strong shock wave hit my house. More than 4,000 pounds of high explosives were detonated in front of the federal office building.

"Within less than an hour following the blast, the cellular phone system was on overload with the landlines following shortly after. Frantic pleas to the public to not use the phones prevented total meltdown. To say that radio communications were important was an understatement.

"At first, the police were using 158.790 (Central) as the primary channel, but as soon as a command post could be set up, the blast site control became 158.730. The search and rescue operation headed by the Fire Department was established on 453.600. Because of all the metallic rubble and the location downtown, rescue communications on 453.600 were erratic. FEMA established a repeater downtown

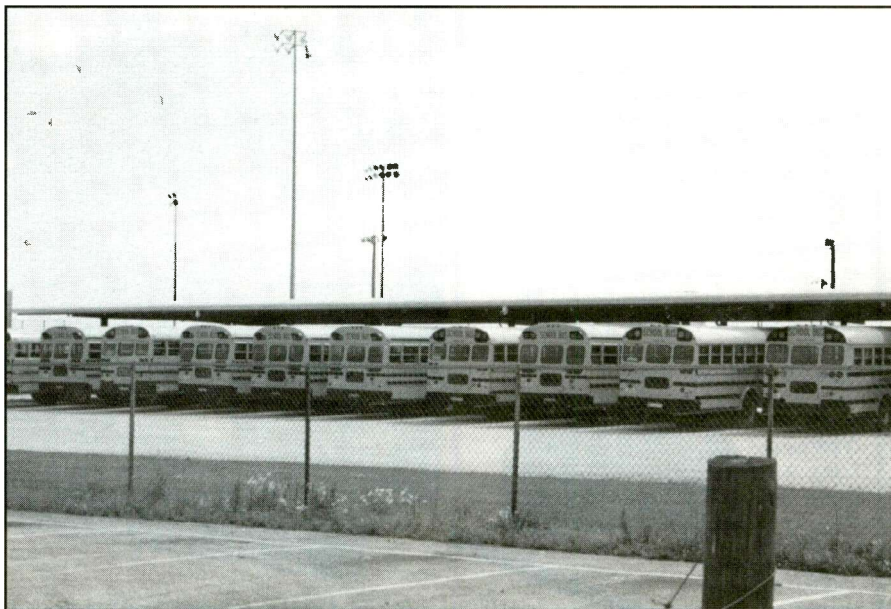

Autumn means frequencies used by school buses become active once again after a summer hiatus. To find frequencies typically used by school buses in your community, check the 155 MHz special emergency frequencies, as well as business frequencies in the 151, 154 and 461-465 MHz bands. (Photo by Chuck Gysi, N2DUP)

to correct the problem the next day after the blast. They arrived on site the evening of the blast and were heard on 139.950 connecting power to their facility and establishing INMARSAT (satellite) and HF links.

"At one time, there were probably 100 or more active frequencies in one way or another involved with the disaster: everyone from the food delivery trucks and hams to the FBI."

Here's a list of frequencies of an emergency nature that Dick monitored a fair deal of disaster-related traffic on: 155.490, state net; 418.900, Drug Enforcement Administration; 165.2875, Bureau of Alcohol, Tobacco and Firearms; 863.2125, Oklahoma State Highway Patrol; 44.70, Oklahoma State Highway Patrol; 163.200, U.S. Marshal Service; 154.665, Oklahoma State Bureau of Investigation; 460.350, Oklahoma County Sheriff; 154.830, Oklahoma Bureau of Narcotics and Dangerous Drugs; 453.600, Oklahoma City Fire search and rescue on-site; 139.950, Federal Emergency Management Agency; 158.790, Oklahoma City police Central Division-Will Rogers Channel 9; 155.235, Oklahoma State Emergency Operations Center; 163.5375, Tinker Air Force Base security; 462.700, General Mobile Radio Service (heavy equipment at the site); 155.805, Canadian County Sheriff; 415.200, FBI command post (Editor's note: This frequency normally is used by the General Services Administration Federal Protective Service, which provides se-

curity service in federal buildings); 155.340, ambulance to hospitals; 167.5625, FBI Channel D; 166.5125, Secret Service Sierra channel; 165.375, Secret Service Charlie channel; 151.310, Oklahoma City police Channel 13—presidential escort from Tinker Air Force Base to the state fairgrounds for a memorial service; 155.475, national law enforcement emergency channel; 172.685 and 170.950, digitally encrypted traffic (most likely FBI).

Dick's report was excellent. If you aren't ready to monitor a major emergency in your own town or city, there's no time like the present to plan! Draw together a list of frequencies that could become active in your community should a major accident occur. Have the lists ready to program your scanners, or keep a bank or two in your scanner loaded with frequencies that could be used to monitor major events.

Toronto Freqs

Vaughan Huska writes from Toronto, Ontario, with an interesting list of 800 MHz frequencies used by the police in that Canadian city. But first, here is some background information from Vaughan:

"The Toronto area has a population of about two million people, the largest metropolitan area in Canada. The city itself is about 28 miles from east to west and 12 miles from north to south.

"The police force is broken up into five districts and each district is broken up into

divisions. Each district averages three divisions, with only one with as many as five divisions, District 5."

Vaughan also notes for those considering visiting Ontario that there are no restrictions or laws preventing listeners from carrying scanners or having them in vehicles.

Here are the frequencies in use in Metro Toronto:

1 District—11 Division, 862.7375; 12 Division, 862.2375. 13 Division, 863.6875; 14 Division, 857.4125 (great downtown area listening and activity); 14B Division, 862.9125; 1 District headquarters, 861.6875; 1 district simplex, 857.4875.

2 District—21 Division, 861.9875; 22 Division, 862.4875; 23 Division, 862.9875; 2 District headquarters, 861.4875; 2 District simplex, 857.1875.

3 District—31 Division, 863.2375; 32 Division, 862.1875; 33 Division, 862.4375; 3 District headquarters west, 861.9375; 3 District headquarters east, 861.7375; 3 District simplex, 857.2375.

4 District—41 Division, 863.4125; 42 Division, 862.6875; 42B Division, 863.1875; 4 District headquarters west, 862.9375; 4 District headquarters east, 861.6625; 4 District simplex, 857.4375.

5 District—51 Division, 861.9125 (great for downtown activity and listening); 52 Division, 857.1625 (great for down-

town activity and listening); 52B Division, 862.1625; 53 Division, 863.4375; 54 Division, 862.4125; 55 Division, 862.6625; 55B Division, 863.1625; 5 District headquarters, 861.4375; 5 District simplex, 859.4125.

Miscellaneous police—Metro Toronto Police Marine Unit, 861.1875 (located in 52 Division south of the Skydome); Emergency Task Force F1, 857.2125; Emergency Task Force F2, 857.4625.

Here are some additional frequencies Vaughan sent along:

Skydome trunked system—813.025, 813.275, 813.525, 813.775, 814.025.

Skydome—457.525

CN Tower—151.115, 452.5375, 462.825.

Metro Toronto Convention Center—451.1875, 451.7875, 452.8125, 454.225, 456.7875, 464.6875.

DEN Switch

With the switch earlier this year from Denver's Stapleton Airport to the new Denver International Airport, listeners in Colorado may want to listen to these new frequencies for the new airport that were sent in by a reader: 134.025, airport terminal information system (ATIS) broadcasts; 118.750, outbound taxiing instructions; 123.300, runways 8/26 and 17L/

35R control tower; 132.350, runway 17R/35L control tower; 133.300, runway 7/25 control tower; 135.300, runway 16/34 control tower; 121.850, runways 8/26, 17R/35L and 17L/35R ground control; 127.500, runway 7/25 ground control; 128.750, runway 16/34 ground control; 129.025, Concourse A ramp control; 131.075, Concourse B north side ramp control; 129.500, Concourse B south side ramp control; 129.850, Concourse C ramp control; 131.975, cargo ramp control; 127.050, north departure; 128.250, east and south departure; 126.100, west and south departure; 118.975, 119.300, and 120.350, distant fixes into landing pattern approach; and 120.800, 123.850 and 125.750, final approach.

Write In

What are your favorite frequencies? Do you have any scanner-related questions? Do you have any listening tips worth passing along to your fellow readers? How about sending in a photo of your listening post or antenna farm? Write to: Chuck Gysi, N2DUP, Scanning VHF/UHF, Popular Communications, 76 N. Broadway, Hicksville, N.Y. 11801-2909, or e-mail to POPCOMM@aol.com or POPCOMM@genie.geis.com via the Internet. ■



Don't miss all the action!!

Join the Bearcat Radio Club Today!!

The Bearcat Radio Club membership offers:

1. The *National Scanning Report*, America's #1 all-scanning magazine. A FREE year subscription to every member.
2. A FREE frequency list for your county.
3. FREE access to our computer bulletin board and national frequency database -- members only.
4. FREE Classified ads - Buy, Sell or Trade.

TWO GREAT LEVELS OF MEMBERSHIP

ASSOCIATE MEMBERSHIP - \$19.90
Includes all of the benefits listed above.

FULL MEMBERSHIP - \$29.90
Includes all of the benefits listed above PLUS a free copy of the *Betty Bearcat Frequency Directory* book (a \$14.95 Value)

Join TODAY!!

Call 1-800-423-1331

Bearcat Radio Club, P. O. Box 291918, Kettering, OH 45429

Daiwa's PS50™ Power Supply...



More Power, Features and Quality...For Less!

Daiwa's very compact "Powerhouse" • Their smallest adjustable voltage and voltage & current metered regulated DC supply! Binding posts & cigarette lighter socket outputs. Perfect for handheld and mobile scanners, HamBand H.T.'s and CB's.

DAIWA

Available at your favorite dealer.



Electronic Distributors Corp.
 325 Mill St. Vienna, VA. 22180
 Phone: (703)-938-8105 • FAX: (703)-938-4525



Exclusive North and South American Distributors

CIRCLE 58 ON READER SERVICE CARD

BROADCAST DX'ING

BY TIM KRIDEL

DX, NEWS AND VIEWS OF AM AND FM BROADCASTING

Bits of the Future: One of the hottest topics in radio today is digital audio broadcasting (DAB), a method of digitally encoding and transmitting audio and signals, with different systems for AM and FM. DAB prototypes made quite a splash at the National Association of Broadcasters' April convention, impressing those in both the industry and the FCC. Commission officials said that they now were interested in considering proposed rulemaking, a promising first step toward realizing DAB in the marketplace. FCC Chairman Reed Hundt, absent from last year's convention, listened to a taped demonstration by DAB developer USA Digital Radio and asked how much new spectrum the system would require. Hundt subsequently was lambasted in the industry press for his apparent ignorance of the fact that DAB is in-band and on-channel, meaning the system makes use of existing spectrum and bandwidth space.

Real-world demonstrations of DAB included rides around the Las Vegas convention site on a bus equipped with digital and analog receivers. AM broadcasts originated from KUSA, a temporary, 10-kW convention station on 1660 kHz, while FM broadcasts came courtesy of KUNV. The test also allowed listeners to switch between

RUSH On Board
WBAP 820 **1-4 pm**

With its 50-kW signal, Fort Worth, Texas' WBAP can be heard in much of the Midwest. The station first signed on May 2, 1922. (Courtesy Michael Forinash, Sioux Falls, South Dakota.)

WBHY **96 AM**
84 AM **WLPR**

Mobile, Alabama, is home to WBHY, with a 10-kW daytime-only outlet on 840 kHz, and 33 kW on 88.5 MHz. Parent company Goforth Media, Inc. also owns Prichard, Alabama's WLPR-AM. (Courtesy Wilbur Goforth, president of Goforth Media Inc.)

Seeking Permits to Construct New FM Stations

AK	Houston	92.1 MHz	6 kW	MN	Hermantown	92.1 MHz	780 watts
AK	Seward	105.9 MHz	3 kW	MN	Nashwauk	102.9 MHz	
AL	Addison	105.7 MHz	6 kW	MN	Walker	101.9 MHz	6 kW
AL	Chatom	106.1 MHz	19 kW	MS	Greenville	104.7 MHz	50 kW
AR	Pine Bluff	91.1 MHz	1 kW	MS	Pascagoula	88.9 MHz	28 kW
AZ	Dreamland	89.1 MHz	1 kW	MT	Hamilton	91.9 MHz	850 watts
AZ	Nogalez	99.1 MHz	6 kW	MT	Missoula	91.3 MHz	1 kW
AZ	Prescott	89.3 MHz	100 watts	NC	Norlina	94.3 MHz	6 kW
AZ	Show Low	90.7 MHz	100 watts	NC	Wilmington	89.7 MHz	1 kW
CA	Lompoc	90.5 MHz	1 kW	NH	New London	90.9 MHz	250 watts
CA	Los Molinos	101.7 MHz	6 kW	NJ	Rio Grande	89.1 MHz	50 kW
CA	McCloud	91.9 MHz		NM	Bernalillo	90.5 MHz	127 watts
CA	Point Arena	102.3 MHz	1.2 kW	NV	Mopa Valley	104.7 MHz	3 kW
CA	Templeton	100.5 MHz		NY	Alfred	101.9 MHz	1.3 kW
FL	Apalachicola	105.5 MHz	6 kW	NY	Jefferson	102.1 MHz	6 kW
FL	Dinsmore	89.3 MHz	1 kW	NY	Minneto	106.5 MHz	5 kW
HI	Hanalei	90.9 MHz	900 watts	OH	Athens	95.9 MHz	6 kW
HI	Lihue	90.1 MHz	100 watts	OH	Bryan	90.9 MHz	750 watts
IA	Madrid	96.1 MHz	6 kW	OH	Beach City	88.7 MHz	3.3 kW
IL	Effingham	91.3 MHz	30 kW	OH	Defiance	91.9 MHz	6 kW
IL	Taylorville	94.3 MHz		OH	Piketon	100.1 MHz	3 kW
IL	Virginia	101.3 MHz	6 kW	OH	Spencerville	88.1 MHz	3 kW
IN	Anderson	89.5 MHz	400 watts	OR	Bonanza	102.9 MHz	785 watts
IN	Indianapolis	88.1 MHz	100 watts	OR	Keno	98.5 MHz	6 kW
KS	Hill City	101.9 MHz	100 kW	OR	Merrill	105.7 MHz	112 watts
MA	Nantucket	91.1 MHz	2 kW	OR	Milton-Freewater	88.5 MHz	
ME	Freeport	89.3 MHz	8 kW	PA	Johnstown	89.7 MHz	8 kW
ME	Isleboro	105.5 MHz	25 kW	TN	Cookeville	91.7 MHz	500 watts
ME	Winter Harbor	97.7 MHz	6 kW	TN	Dickson	91.5 MHz	6 kW
MI	Benton Harbor	94.9 MHz	6 kW	TX	Borger	91.5 MHz	10 kW
MI	Harbor Beach	103.7 MHz	47 kW	TX	Dimmit	100.5 MHz	
MN	Deer River	105.5 MHz	100 kW	VA	Brunswick	103.1 MHz	1.8 kW
				WA	Quincy	95.9 MHz	2.5 kW
				WI	Balsam Lake	104.9 MHz	
				WY	Powell	104.1 MHz	78 kW

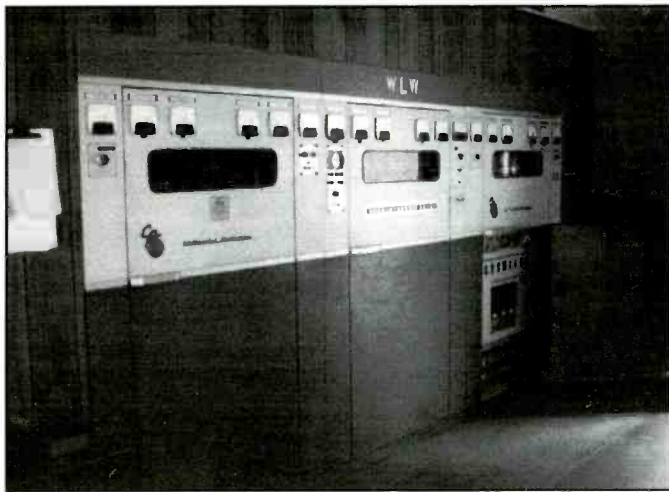

A view of the Continental Electronics transmitter at Cincinnati, Ohio's WLW, taken by James H. Young, Springfield, Virginia. The station first took to the air on March 22, 1922.

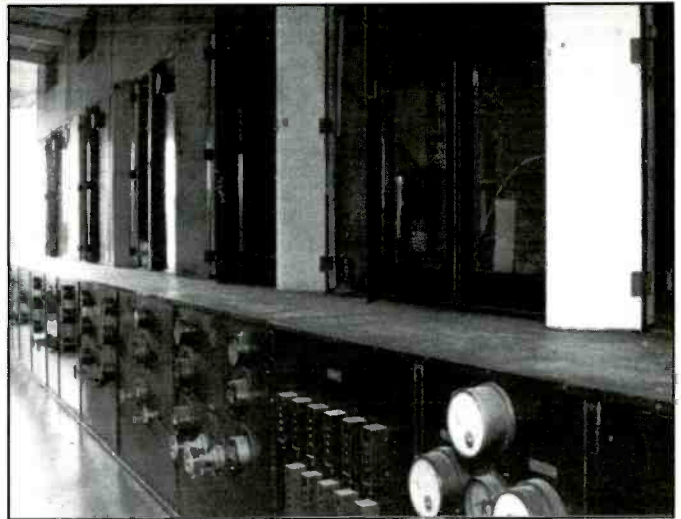

This is some of the hardware that puts WLW's 50-kW signal on 700 kHz. (Courtesy James H. Young.)

the two methods for side-by-side comparisons of digital and analog.

Among the NAB '95 attendees was POP'COMM reader Gregory R. Deprez, who sent us a brochure titled "Everything You Always Wanted to Know about DAB But Were Afraid to Ask," from one of its developers, Harris Allied. The primer states that one advantage DAB has over current analog broadcasting is an improved audio quality: AM can achieve a 15-kHz

stereo signal, up from analog's 10 kHz, and FM can rival compact discs with its 20-kHz signal. Another major advantage for FM is that a digital signal can overcome multipath distortion, which results when the signal bounces around obstacles such as buildings and mountains. Harris Allied also claims that a digital AM signal "eliminates or greatly reduces...noise and static." However, engineers at USA Digital Radio admitted that hurdles do remain in overcoming effects on

the AM signal's integrity from power lines and tunnels.

Of particular interest to AM DXers is how digital signals fare via skywave. While admitting that "nobody knows" whether a DAB signal could be received via skywave, engineers reason that if it "is a strong, stable signal, it should be possible. But AM system developers are concentrating on serving the needs of local broadcasters. DAB skywave would be a plus, but it isn't

Get A New Image

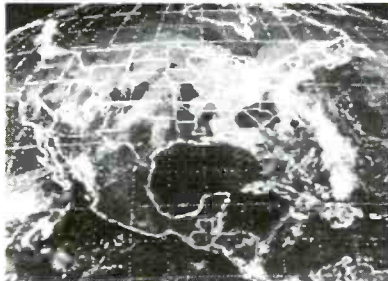

PC HF Facsimile \$99

PC HF Facsimile is a simple, yet comprehensive short-wave fax system for the IBM PC and compatibles. It includes an FSK demodulator, advanced signal processing software, tutorial audio cassette, and complete reference manual. Just plug the demodulator into a serial port, install the software and getting FAX is a snap.

PC SSTV \$149.95

PC Slow Scan Television is a complete system for sending and receiving full color amateur SSTV. The package includes an SSTV FSK modem, SSTV software, image capture utilities and reference manual. All popular formats are supported including Robot, Scottie, Martin and AVT. The system requires a 286, 386 or faster PC with VGA or super VGA display.



Have It All For Only \$199.95

For a limited time we are offering both software packages with a single FSK modem for under \$200. This combination offer will let you send and receive all the popular HF image transmission modes.

Call or write for our free catalog. Visa and Mastercard welcomed.

Software Systems Consulting
615 S. El Camino Real, San Clemente, CA 92672
Tel. (714) 498-5784 Fax. (714) 498-0568

AR8000 Interface

Computer Interface for the AR8000

- △ Low Power, powered by your serial port
- △ No Drain on the batteries in the radio
- △ Light weight, perfect for Laptop use
- △ As small as a DB-25 Connector
- △ Hi-Tech Surface mount design for reliability
- △ 100% Shielded cable to receiver for reduced interference
- △ PC Software included for Windows and DOS
- △ Manual included
- △ Detailed Programers documentation available
- △ Designed and Manufactured in the USA
- △ Optional 100% shield computer cable from AR8000INF to computer for reduced interference

Unlike some of the European devices sold today, this unit is smaller, lighter, and makes no power demands on your receiver. With the extra shielding and smaller size there is less chance of additional interference leaking into your radio. The AR8000INF is also the only interface that is upgradeable for use with the optional Tape recorder controller due first quarter '95.



Electronic Distributors Corp.

325 Mill St. Vienna, VA, 22180
Phone: (703)-938-8105 • FAX: (703)-938-4525
Available at your favorite dealer.



Changed FM Call Letters

New	Was	
KBOA-FM	KTEI	Piggott, AR
KCQQ	KRVR	Davenport, IA
KCTI-FM	KPJV	Gonzales, TX
KDDX	KEZV	Spearfish, SD
KEWL	KBWE	New Boston, TX
KJEM	KESE	Seligman, MO
KJSR	KTFX	Tulsa, OK
KKBH	KCLX-FM	San Diego, CA
KLND	KAEN	Little Eagle, SD
KLYD	KXHA	Shafter, CA
KNAC	KNKD	Earlimart, CA
KNBA	KANH	Anchorage, AK
KNRK	KMUZ-FM	Camas, WA
KNRX	KYBG-FM	Castle Rock, CO
KORB	KQCS	Bettendorf, IA
KYGL	KUKB	Texarkana, AR
WBCI	WKRH	Bath, ME
WEWM	WSAB	Pentwater, MI
WGTH-FM	WGTH	Richlands, VA
WHID	WYPD	Green Bay, WI
WIST-FM	WLWW	Waxhaw, NC
WJUF	WWUA	Inverness, FL
WJUX	WXTM	Monticello, NY
WMFS	WRRW	Bartlett, TN
WMJA	WUVE	Saginaw, MI
WMJK	WBTZ	Pinconning, MI
WMOS	WZLZ	Quincy, IL
WMTT	WXEJ	Conklin, NY
WMXN	WKZA	Stevenson, AL
WNVE	WRQI	S. Bristol, NY
WNZZ	WSYA	Montgomery, AL
WRRV	WKOJ	Middletown, NY
WSGF	WQQT	Springfield, GA
WXKW	WMHU	Renovo, PA
WXRR	WHSY-FM	Hattiesburg, TN
WYMR	WCAC	Sebring, FL
WZBZ	WNWX	Plattsburgh, NY.

Canceled

KECU	Ada, OK	91.3 MHz	2 kW
WRLQ	Ladson, SC	106.3 MHz	3 kW

Changed AM Call Letters

New	Was	
KBKW	KAYO	Aberdeen, WA
KESE	KJEM	Bentonville, AR
KMXZ	KJYX	Tucson, AZ
KNSN	KHSL	Chico, CA
KXSP	KAHS	Ventura, CA
WBIV	WBPS	Natick, MA
WBZS	WCPT	Alexandria, VA
WGTH	WRIC	Richlands, VA
WKYN	WBND	Florence, KY
WNZZ	WSYA	Montgomery, AL
WPFC	WLUX	Baton Rouge, LA
WZBZ	WNWX	Plattsburgh, NY
WZKD	WOMX	Orlando, FL

Pending FM Call Letter Changes

New	Old	
KHWG	KBCH-FM	Kings Beach, CA
KJQY	KKMY	Orange, TX
KLLR	KBUD	Amarillo, TX
KQOL	KRRI	Boulder City, CO
KRNB	KSTV-FM	Decatur, TX
WBCI	WKRH	Bath, ME
WEYQ	WURN	Marietta, OH
WXVR	WZYQ	Braddock Heights, MD
WYSR	WTRY-FM	Rotterdam, NY

Granted Permits to Construct New FM Stations

AK	Juneau	102.7 MHz	6 kW
HI	Kalahlui	103.7 MHz	211 watts (KNUQ booster)
MT	Great Falls	88.9 MHz	6 kW
PA	New Castle	90.1 MHz	2 kW

Modified AM Facilities

KIAM	Nenana, AK	630 kHz	Increased to 10/3.2 kW.
WAYR	Orange Park, FL	550 kHz	Added nights with 260 watts.
WLWI	Montgomery, AL	740 kHz	Dropped daytime to 10 kW

a goal." Since the technology still is being tested, it isn't clear yet whether or how DAB might affect signal coverage. As with analog, interference from other stations remains a concern, but "as long as a station maintains a signal that is 26 dB stronger than an interfering co- or first adjacent, the DAB signal should be received with no problem." For more information, contact Harris Corporation, Broadcast Division, 3200 Wismann Lane, P.O. Box 4290, Quincy, Illinois 62305-4290.

As DAB made its debut, another type of digital broadcasting was gearing up to promote itself in the consumer marketplace. Radio Broadcast Data System, referred to as RBDS or RDS, allows an FM broadcaster to piggyback digitally encoded data on its signal, which then is decoded by the listener's specially equipped receiver. Although a similar system has been in place in Europe for nearly a decade, RBDS has yet to achieve a significant foothold in the U.S., with only about 250 of the 5,000-plus FM stations using the system.

In an effort to educate the public about RBDS, the Electronic Industries Associa-

tion's (EIA) Consumer Electronics Group announced in early April that five Philadelphia stations agreed to broadcast RBDS as part of its \$500,000 national promotion. The addition of WUSL, WIOQ, WWDB, WMGK, and WXTU brings the total number of RBDS stations in the city to 11, giving the service a penetration of 36.3% in the Philadelphia market. A news release announcing the campaign notes that "in exchange for the equipment provided by the EIA, the stations will air ads or announcements to educate listeners about RBDS and promote the use of RBDS radios." No word on what sort of information the stations will transmit on their RBDS subcarriers, but it may include information such as call letters, format, song title and artist, traffic alerts, news headlines, and stock tickers. Whether the RDS logo becomes as commonplace as that of "Compact Disc Digital Audio" remains to be seen, but the technology may receive a boost from the emerging DAB, because industry watchers predict that DAB eventually will incorporate RBDS in some form.

Radio-On-Demand: Beginning this

summer, radio listeners who also are computer buffs can enjoy some of their favorite programs at their convenience, thanks to "RealAudio." A Seattle-based software company, Progressive Networks is offering the service to Internet users who will be able to pick which broadcasts they want, when they want them. Initial selections will include news, sports and entertainment from ABC, and portions of National Public Radio's "All Things Considered" and "Morning Edition" programs.

Although this isn't the first time audio has been offered on the Internet, RealAudio will eliminate the usual lengthy download time by using data compression. The resulting sound quality has been compared to that of AM, which may explain why music remains scarce in cyberspace. More information is available at Progressive Networks' Internet World Wide Web address of <http://www.realaudio.com>

Money Changes Everything: In a move at least as surprising as their departure for St. Louis, the NFL Rams in early May awarded their radio rights to KSD Radio. The seven-year deal, worth nearly \$50 mil-

lion, usurps KMOX-AM's virtual lock on sports radio in the city. The deal includes an average annual cash payment of more than \$3.5 million, \$1.1 million more per season than KMOX's final offer, according to reports in the *St. Louis Post-Dispatch*. Officials of the franchise and KSD also cited the fact that the station would provide the Rams with a broader audience than 50-kW KMOX because it would have both AM and FM outlets. Plans are to have different pre- and postgame shows on KSD-AM and KSD-FM, as well as separate coach's shows.

The deal rides the current wave of Ramsmania in the Gateway City, but some remain skeptical. As one KMOX staffer pointed out, "The first year will be KSD's best, with advertisers hopping aboard because it's the team's first year in St. Louis. But when they see the [ratings] numbers, that will end." The *Post-Dispatch* cited another broadcast industry source, who called KSD's bid "outrageous," pointing out that in Los Angeles the Rams generated only \$1.05 million in advertising revenue last season.

Public Broadcasting: The city of New York struck a deal earlier this year with a not-for-profit citizens group to sell WNYC-AM/FM for \$20 million. The city's non-commercial station will go to the WNYC Foundation for \$20 million, to be paid out over six years. Industry brokers estimate that the station could go for \$35 million to \$40 million on the open market, according to *Broadcasting & Cable* magazine. WNYC-TV is not part of the deal, but instead will be placed on the open market. Mayor Rudolph Giuliani, who last year began considering the sale of the FM outlet as a means to ease the city's deficit, stated in the announcement that "broadcasting is not at the core of the business of city government. Cities don't belong in—and don't do well in—the broadcasting business."

Tax Tips: In a bizarre, precedent-setting combination of legal and antenna theory, an East Rutherford, New Jersey, station in late March won a half-million-dollar tax refund. WEVD-AM's 22.5-acre antenna farm, located on Route 120 near the Brendan Byrne Arena, had been assessed at \$18 million, while the property's owner maintained it was worth only \$5 million. WEVD successfully challenged the assessment in court, where a state tax judge ruled that the property was worth \$6 million, and granted the landowner a \$500,000 tax refund for 1991 through 1994. "This was the first case in New Jersey in which radio towers were found not to be taxable," a lawyer for the station said.

According to an article in *The (Bergen County, New Jersey) Record*, sent to us by readers Stephen B. Dobrow and Louis J. Sicilia, the judge based his decision on antenna theory—because an AM antenna's tower radiates the station's signal, it is considered business equipment, not property. An FM antenna tower, however, is consid-

ered property—and, therefore, taxable—because the structure doesn't actually transmit the signal.

The decision has town officials shaken up because the 7,000-acre "Meadowlands" has long been considered prime broadcast real estate for its marshy soil, which makes an excellent ground, and for its close proximity to New York City. At present, at least nine AM stations have transmitter sites in the Meadowlands, but whether the judge's ruling will lead to similar assessment challenges remains to be seen. In the meantime, the town must not only raise the \$500,000 to pay back the property owner, but also come to terms with a loss of \$16.5 million in tax ratables.

Don't Believe Everything You Hear: With catchy slogans being favored over dry legal IDs, figuring out who you're hearing has become almost as difficult as tuning them in. *POP'COMM* reader George Saunders, of Modesto, California, wonders how a two-year-old station in Sacramento can ID as "KST" when the FCC quit issuing three-letter calls a few years back. In reality, it isn't about three-letter calls at all, but rather the fact that call letters and city of license have been banished to sometime between :55 and :05. The 650 kHz station, licensed to Rancho Cordova, actually is KSTE.

Some broadcasters will take even greater license with their calls. When I lived in Long Island in the late 1980s, I logged a station on 930 kHz that repeatedly IDed as "KOST, coast AM 930." I was, of course, quite excited by the catch because K calls were few and far between on the East Coast. Unfortunately, the plum shriveled to a prune when, at the top of the hour, they turned out to be "WKOS, original hits for New Hampshire's coast, KOST AM 930."

In Brief: Back in the December 1994 issue, readers Joel M. Rubin and Peter F. Warncke told us that San Francisco area stations KKHI-AM/FM had in June 1994 dropped a classical music format for news on weekdays and "a taste of jazz" on weekends as KPIX, "The Express." Peter checks back in to report that KKHI was reborn on

New FM Call Letters Issued

KAKA	Kennett, MO
KAKH	Flagstaff, AZ
KAKK	Chinle, AZ
KAKO	Gooding, ID
KGGG	Sterling, KS
KGPQ	Monticello, AR
KITI-FM	Winlock, WA
WAKP	Dalton, GA
WHTX	Mound Bayou, MS
WKLR	Veedsburg, IN
WUPN	Mexico, NY

both 1510 kHz and 100.7 MHz, IDing as "KKHI San Rafael/San Francisco," with a repeater, K265DI, in Sausalito. However, by the time you read this, KKHI-AM will have undergone yet another change: Peter says that the station announced that it became KNOB, with a jazz format, beginning April 3.

If you've ever called a radio station as part of an on-air contest, only to find that you can't get through, it may be more than the odds against you. According to an Associated Press story in *The Edmonton (Alberta) Journal*, sent to us by Trevor Fletcher, a computer hacker in April admitted to having blocked incoming telephone lines at Los Angeles stations KJIS-FM, KPWR-FM, and KRTH-FM during contests in 1989, allowing only him to get through. Among the prizes he won were two Porsches, two trips to Hawaii, and a total of \$22,000 in cash. The former computer security consultant to the Pentagon was sentenced to four years in prison and fined \$58,000.

Thanks: Regular *POP'COMM* readers will recognize the name of Trevor Fletcher, who contributes to several of our columns. In a recent letter, he wrote, "I really love seeing things published that I've sent in. It's great to have a share in the magazine." I couldn't have said it better. To all the readers who have written in with kind words about the column, I can only respond that you have yourselves to thank. This column wouldn't be what it is without your support. Keep it coming! Until next month, 73. ■



+30db

The Original ... **Select-A-Tenna** ★★★★★

- AM RADIO ANTENNA WORKS WITH THE BUILT-IN ANTENNA IN YOUR RADIO
- NO WIRES TO CONNECT
- NO BATTERIES
- HIGH-Q SUPER GAIN AND SELECTIVITY
- PROVEN WORLD-WIDE FOR OVER 22 YRS
- SATISFACTION GUARANTEED
- THIS ONE REALLY WORKS!

INTENSITRONICS CORP.
P.O. BOX 562 DEPT. Q
HALES CORNERS, WISC. 53130

\$59.95 PLUS SHIPPING

TOLL-FREE
1-800-382-4155
FAX
1-317-883-7555

MADE IN USA

CIRCLE 163 ON READER SERVICE CARD

Digital Radio is Coming!

The sounds you hear on your radio are going to change. The National Association of Broadcasters and the Federal Communications Commission have just completed a test of digital radio, and the commission has announced it is ready for the proposed rulemaking to begin.

Most of us already are aware of the clean, clear, almost lifelike sounds that are available from a CD player or digital tape. Some of the latest satellite technology has been appearing in your local paper as digital satellite television is being sold to those who want clear signals, small satellite dishes and a massive number of channels to select from. Commercial two-way radio manufacturers already are offering digital trunked systems on the 800 MHz bands. What's next? Digital AM and FM radio is just around the corner!

At the National Association of Broadcasters Convention in Las Vegas in April, the NAB, broadcasters, equipment dealers and the FCC were exposed to the first really extensive demonstration of digital radio broadcasting. Although the FCC and the manufacturers of digital systems and equipment still have to get together on the details of the standards to be used, the FCC has indicated it is eager to get started on the proposed rules and regulations that will control and regulate the new crystal-clear broadcasting service.

Most of us listen to the radio when we are in the car. Except for a few people who enjoy the radio as background music at work or in the home, radio broadcasters realize that most of the listening audience is in a mobile mode. With this in mind, the USA Digital Radio demonstration at the Las Vegas NAB Convention was presented to a mobile audience by way of a bus that was outfitted with a digital receiving radio and headphones for those on board. During the demonstration rides, the bus took listeners by tall buildings, malls, in and out of traffic and under overpasses. The equipment allowed each listener to switch between the digital signal and the current analog broadcast to hear the difference between the quality of the systems.

The KUNV antenna was used in the demonstration. This antenna is located some distance away from Las Vegas, and has been known for some of the worse multipath signals in the Vegas listening area. Those on board the bus found that digital radio was impressive, clear, and offered some outstanding listening.

Let's pause here for a brief explanation on how digital radio works. Digital radio, whether a police dispatcher on 800 MHz

or a broadcasting station, all starts out as a sound. The sound can be the dispatcher's voice or the drum on the CD. As the sound is processed, it is converted into a digital series of 0 and 1 combinations. If the sound were monitored on a regular radio receiver, (called an analog receiver) the sounds probably would sound much like your computer modem when it is being initialized for online use. You could not listen to the music or dispatcher's voice and hear anything but the digital buzz with a standard AM or FM radio or scanner; you would need a digital receiver. It would not only have to be a digital receiver, but it must be equipped with a receiver using the same protocol as the station transmitting the signal.

The FCC is primarily concerned about two things when it asks for information and proposals regarding digital radio. They want to establish the same standards or protocols so that all radio stations are broadcasting the same kind of signal. Once the protocol is established, radio receiver manufacturers can make one standard radio that will be able to receive all the digital stations. The FCC also wants to make the transition from analog radio reception to digital radio as easy as possible. Remember several decades ago when the UHF TV channels were allocated? Stations above Channel 13 were licensed and went on the air, so the FCC passed a rule requiring all new TV sets have the capability to receive the new UHF channels as well as older VHF Channels 2-13.

It appears that the protocols for digital radio broadcasting are pretty well set. The FCC soon will fine tune the protocol and write the technical rules on this. Next, the commission will set the "type acceptance standards" for all manufacturers, incorporating the new selectable digital receiving ability into new radios. In this case, the consumer probably will be begging for the new digital access long before the radio becomes easily available, as digital radio will allow for static-free and fade-free CD-quality listening. Prices will be high at first, but then they should come down rapidly.

The music industry is concerned about something that is worth mentioning. With digital tape recorders already on the market, the music industry already is voicing concern about incorporating a method to keep a digital tape recorder owner from tuning in a digital radio station that is playing the latest hit, and making his or her own CD-quality tape of the song. If this happens, the record and tape industry will be hurt. Why would anyone want to go out and buy a CD if they could simply tape their

favorite songs off the air and have them on crystal-clear digital audio tape? You can bet there is going to be something built into the system that will prevent a listener from making his or her own digital tapes directly from digital radio. The FCC certainly will look into this as they set the standards and make the rules.

Digital radio transmissions, whether they be a police dispatcher on a commercial two-way radio system or a broadcaster playing a song, all have the same requirement for being received and heard. All the "1"s and "0"s that make up the digital signal must be received completely by the receiver, or there is an incomplete transmission. When the receiver does not get all the parts of the digital signal, the signal is not there. The receiver requires a complete digital signal to reconstruct the sound, be it music or voice. Without the complete signal, there is no sound. Digital AM radio will make the greatest difference in that there will be no more fading and no more static. The sound of digital AM radio is truly going to be the salvation of AM radio in the future, as AM will be able to offer clear, static-free, CD-quality listening that is equal to that found on FM digital radio.

The FCC also will have to set new frequency standards. Digital signals take up much less space on the radio band, so there may be room for many more stations both on the FM and AM bands. The commission wants to look out for the person who doesn't have a digital radio, and for the broadcaster who wants to change from analog broadcasting methods, too. This will be one of the prime considerations as the FCC starts working on this new method of broadcasting. New radios will have to be designed so they can select analog and digital reception, much like you switch between FM and AM today. AM digital radio and its 15-kHz stereo signal will offer radio engineers their greatest challenge. You can expect the new digital radio for automobile use to run at least 15 percent to 20 percent more than the standard AM-FM radio seen today, but the superior digital sounds will make them an easy selling item.

Those working on digital radio broadcasting standards in Europe are pressing the FCC to fully consider the Eureka-147 system standards. This system seems to be gaining popularity in Europe. By working together and accepting a standard that is adopted worldwide, you will be able to take your digital radio anywhere and enjoy excellent reception. Canada is leaning in the direction of the Eureka-147 standards.

(Continued on page 82)

Tap into secret Shortwave Signals

Turn mysterious signals into exciting text messages with this new MFJ MultiReader™

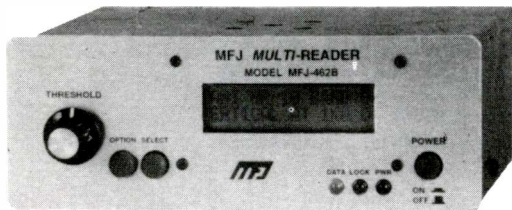

MFJ-462B Plug this self-contained MFJ MultiReader™ into your shortwave receiver's earphone jack.

Then watch mysterious chirps, whistles and buzzing sounds of RTTY, ASCII, CW and AMTOR turn into exciting text messages as they scroll across your easy-to-read LCD display.

You'll read interesting commercial, military, diplomatic, weather, aeronautical, maritime and amateur traffic... traffic your friends can't read -- unless they have a decoder.

Eavesdrop on the World

Eavesdrop on the world's press agencies transmitting unedited late breaking news in English -- China News in Taiwan, Tanjug Press in Serbia, Iraqi News in Iraq -- all on RTTY.

Super Active Antenna

"World Radio TV Handbook" says MFJ-1024 is a "first rate easy-to-operate active antenna... quiet... excellent dynamic range... good gain... low noise... broad frequency coverage."

Mount it outdoors away from electrical noise for maximum signal, minimum noise. Covers 50 KHz to 30 MHz.

Receives strong, clear signals from all over the world. 20dB attenuator, gain control, ON LED. Switch two receivers and aux. or active antenna. 6x3x5 in. remote has 54 inch whip, 50 ft. coax.

3x2x4 in. 12 VDC or 110 VAC with MFJ-1024 MFJ-1312, \$12.95.

Indoor Active Antenna MFJ-1020B \$79.95

Rival outside long wires with this tuned indoor active antenna. "World Radio TV Handbook" says MFJ-1020 is a "fine value... fair price... best offering to date... performs very well indeed."

Tuned circuitry minimizes intermod, improves selectivity, reduces noise outside tuned band. Use as preselector with external antenna. Covers 0.3-30 MHz. Has Tune, Band, Gain, On/Off/Bypass Controls. Detachable telescoping whip. 6x2x6 in. Use 9 volt battery, 9-18 VDC or 110 VAC with MFJ-1312B, \$12.95.

Compact Active Antenna

MFJ-1022 \$39.95

Plug this new compact MFJ all band active antenna into your general coverage receiver and you'll hear strong clear signals from all over the world from 300 KHz to 200 MHz -- including low, medium, shortwave and VHF bands.

Also improves scanner radio reception on VHF high and low bands. Detachable 20 in. telescoping antenna. 9 volt battery or 110 VAC with MFJ-1312B, \$12.95. 3/16x1/4x4 in.

Copy RTTY weather stations from Antarctica, Mali, Congo and many others. Listen to military RTTY passing traffic from Panama, Cyprus, Peru, Capetown, London and others. Listen to hams, diplomatic, research, commercial and maritime RTTY.

Listen to maritime users, diplomats and amateurs send and receive error free messages using various forms of TOR (Telex-Over-Radio).

Monitor Morse code from hams, military, commercial, aeronautical, diplomatic, maritime -- from all over the world -- Australia, Russia, Hong Kong, Japan, Egypt, Norway, Israel, Africa.

Printer Monitors 24 Hours a Day

MFJ's exclusive TelePrinterPort™ lets you monitor any station 24 hours a day by printing their transmissions to your Epson compatible printer.

Printer cable, MFJ-5412, \$9.95.

MFJ MessageSaver™

You can save several pages of text in 8K of memory for re-reading or later review.

High Performance Modem

MFJ's high performance phaselock loop modem consistently gives you solid copy -- even with weak signals buried in noise. New threshold control minimizes noise interference -- greatly

improves copy on CW and other modes.

Easy to use, tune and read

It's easy to use -- just push a button to select modes and features from a menu.

It's easy to tune -- a precision tuning indicator makes tuning your receiver easy for best copy.

It's easy to read -- the 2 line 16 character LCD display with contrast adjuster is mounted on a sloped front panel for easy reading.

Copies most standard shifts and speeds. Has MFJ AutoTrak™ Morse code speed tracking.

Use 12 VDC or use 110 VAC with MFJ-1312B AC adapter, \$12.95. 5 1/2x2 1/2x5 1/4 inches.

No Matter What Guarantee

You get MFJ's famous one year No Matter What™ unconditional guarantee. That means we will repair or replace your MFJ MultiReader™ (at our option) no matter what for a full year.

Try it for 30 Days

Order an MFJ-462B MultiReader™ from MFJ and try it in your own setup -- compare it to any other product on the market regardless of price.

Then if you're not completely satisfied, simply return it within 30 days for a prompt and courteous refund (less shipping).

Order today and try it -- you'll be glad you did.

MFJ Antenna Matcher

MFJ-959B \$89.95

Matches your antenna to your receiver so you get maximum signal and minimum loss.

Preamp with gain control boosts weak stations 10 times. 20 dB attenuator prevents overload. Pushbuttons let you select 2 antennas and 2 receivers. Cover 1.6-30 MHz. 9x2x6 inches. Use 9-18 VDC or 110 VAC with MFJ-1312, \$12.95.

High-Gain Preselector

MFJ-1045C \$69.95

High-gain, high-Q receiver preselector covers 1.8-54 MHz. Boost weak signals 10 times with low noise dual gate MOSFET. Reject out-of-band signals and images with high-Q tuned circuits. Pushbuttons let you select 2 antennas and 2 receivers. Dual coax and phono connectors. Use 9-18VDC or 110 VAC with MFJ-1312B, \$12.95.

Dual Tunable Audio Filter

MFJ-752C \$99.95

Two separately tunable filters let you peak desired signals and notch out interference at the same time. You can peak, notch, low or high pass signals to eliminate heterodynes and interference. Plugs between radio and speaker or phones. 10x2x6 in.

Easy Up Antennas Book

How to build MFJ-38 \$16.95

and put up inexpensive, fully tested wire antennas using readily available parts that'll bring signals in like you've never heard before.

Covers receiving antennas from 100 KHz to almost 1000 KHz. Includes antennas for long, medium and shortwave, utility, marine and VHF/UHF services.

Receive Color News Photos, Weather Maps, RTTY, ASCII, Morse Code

MFJ-1214PC \$149.95

Use your computer and radio to receive and display brilliant full color FAX news photos and incredible WeFAX weather maps with all 16 gray levels. Also RTTY, ASCII and Morse code.

Animate weather maps. Display 10 global pictures simultaneously. Zoom any part of picture or map. Frequency manager lists over 900 FAX stations. Automatic picture capture and save.

Includes interface, easy-to-use menu driven software, cables, power supply, comprehensive manual and Jump-Start™ guide. Requires 286 or better computer with VGA monitor.

Super Hi-Q Loop™ Antenna

The Super Hi-Q MFJ-1782 \$269.95

Loop™ is a professional quality remotely tuned 10-30 MHz high-Q antenna. It's very quiet and has a very narrow bandwidth that reduces receiver overloading and out-of-band interference.

High-Q Passive Preselector

MFJ-956 \$39.95

The MFJ-956 is a high-Q passive LC preselector that lets you boost your favorite stations while rejecting images, intermod and other phantom signals. Covers 1.5-30 MHz. Has preselector bypass and receiver grounded position. 2x3x4 in.

Mobile Scanner Ant.

Cellular MFJ-1824BB/BM \$19.95

look-a-like. Covers 25-1300 MHz. Highest gain on 406-512 and 108-174 MHz, 19 in. Magnet mount. MFJ-1824BB has BNC/UHF plug; MFJ-1824BM has Motorola plug.

MFJ-107B \$9.95

MFJ-108B \$19.95

MFJ-108B, dual clock displays 24 UTC and 12 hour local time simultaneously. MFJ-107B, single clock shows you 24 hour UTC time. 3 star rated by Passport to World Band Radio!

MFJ-105B, accurate 24 hour UTC quartz wall clock with large 10 inch face.

MFJ Antenna Switches

MFJ-1704 \$59.95

MFJ-1702B \$21.95

MFJ-1704 heavy duty antenna switch lets you select 4 antennas or ground them for static and lightning protection. Unused antennas automatically grounded. Replaceable lightning surge protection device. Good to 500 MHz. 60 dB isolation at 30 MHz. MFJ-1702B for 2 antennas.

World Band Radio Kit

MFJ-8100K \$59.95

MFJ-8100W \$79.95

Build this regenerative shortwave receiver kit and listen to shortwave signals from all over the world with just a 10 foot wire antenna.

Has RF stage, vernier reduction drive, smooth regeneration, five bands.

Free MFJ Catalog
Write or Call toll free... 800-647-1800

Nearest Dealer/Orders: 800-647-1800

Technical Help: 800-647-TECH(8324)

• 1 year unconditional guarantee • 30 day money back guarantee (less s/h) on orders from MFJ • FREE catalog

MFJ MFJ ENTERPRISES, INC.
Box 494, Miss. State, MS 39762
(601) 323-5869; 8:43-30 CST, Mon.-Fri.
FAX: (601) 323-6551; Add s/h
MFJ... making quality affordable
Prices and specifications subject to change © MFJ Enterprises, Inc.

POP'COMM's World Band Tuning Tips

September—1995

Freq.	Country/Station	UTC	Notes	Freq.	Country/Station	UTC	Notes
3205	R. Ribeiro Preto, Brazil	0200	PP	7325	BBC, England	0130	
3240	TWR, Swaziland	0300		7345	R. Prague, Czech Rep.	0700	
3250	R. Luz y Vida, Honduras	0100	SS	7360	V of Vietnam, via Russia	0400	
3260	Estereo Carrizal, Ecuador	0600	SS	7370	Croatian Radio	2200	EE/Croat
3290	Namibia Broadcasting Service	0345		7448	V of Greece	0130	
3300	R. Cultural, Guatemala	0300		7465	Kol Israel	0500	
3306	ZBC, Zimbabwe	0300	s/on	7475	RTT, Tunisia	0400	AA
3325	R. Maya, Guatemala	1100	SS	9200	R. Omdurman, Sudan	1800	
3340	R. Altura, Peru	1030	SS	9335	R. Fana, Ethiopia	0327	s/on
3360	La Voz de Nahuala, Guatemala	0300	SS	9375	Voice of Greece	0500	Greek
3366	GBC, Ghana	0600		9440	R. Slovakia Int'l	0100	
3380	R. Chortis, Guatemala	0130	SS	9445	Voice of Turkey	2330	TT
3396	ZBC, Zimbabwe	0256	s/on	9470	Trans World Radio, via Albania	0515	Polish
3905	R. New Ireland, Papua New Guinea	1100		9475	R. Cairo, Egypt	0200	
3945	R. Vanuatu	1030	Pidgin/EE	9530	R. Singapore Int'l	1300	
4450	R. Frontera, Bolivia	0945	SS	9535	R. Japan	1400	
4725	V of Myanmar (Burma)	1200		9540	R. Espana Exterior, Spain	0100	
4760	ELWA, Liberia	0600		9555	R. Veritas Asia, Philippines	1430	
4765	R. Rural, Brazil	0230	PP	9560	Voice of Peace/R. Amaharo, Ethiopia	0400	vern
4770	R. Nigeria, Kaduna	0430		9570	R. Portugal	0230	
4775	Onda Musical, Dom. Rep.	0130	SS	9570	R. New Zealand	0600	
4780	R. Coatan, Guatemala	1130	SS/vern	9580	R. Tirana, Albania	0230	
4785	R. Super de Ibaque, Colombia	0200	SS	9580	Africa No. One, Gabon	1900	FF
4810	Afrikaans Stereo, S. Africa	0300		9590	R. Denmark, via Norway	1330	
4815	RTV Burkina, Burkina Faso	0700	FF	9605	UAE Radio, Abu Dhabi	2300	
4825	R. Mam, Guatemala	0200	SS/vern	9605	Vatican Radio	0330	SS
4832v	R. Reloj, Costa Rica	0500	SS	9610	BBC relay, S. Africa	0230	
4840	R. Valera, Venezuela	0300	SS	9620	R. Dniester Int'l, Moldova	2130	
4850	R. Centenario, Bolivia	1000	SS	9645	Faro del Caribe, Costa Rica	0500	SS
4860	All India Radio, Delhi	1215		9655	Radio Austria Int'l	0130	
4870	ORTB, Benin	0530	FF	9660	R. Rumbos, Venezuela	2300	SS
4885	Ondas del Meta, Colombia	0300	SS	9670	R. Veritas, Philippines	1130	unid II
4885	R. Clube do Para, Brazil	0000	PP	9680	RRI, Indonesia	1230	
4890	NBC, Papua New Guinea	1100	EE	9690	R. Nacional, Argentina	2300	
4890	R. France Int'l, via Gabon	0500	FF	9690	China Radio Int'l, via Spain	0300	
4915	GBC-Radio One, Ghana	0400		9700	R. Bulgaria	0000	
4920	R. Quito, Ecuador	0200	SS	9710	China Radio Int'l, via Mali	0000	
4950	R. Bahai	0800	SS	9715	R. Tashkent, Uzbekistan	1330	
4965	R. Alvorada, Brazil	0100	PP	9725	RAI, Italy	0100	
4980	Ecos del Torbes, Venezuela	0300	SS	9735	R. Nacional, Paraguay	0100	SS
5020	SIBC, Solomon Islands	0800		9745	HCJB, Ecuador	0730	
5025	R. Rebelde, Cuba	0400	SS	9755	Radio Canada Int'l	0000	
5030	AWR-Pan America, Costa Rica	0330	SS	9765	Voice of the Mediterranean, Malta	0600	
5047	RTV Togolaise, Togo	0500	FF	9770	V of UAE, Abu Dhabi	2300	
5055	TIFC, Costa Rica	0400		9780	Yemini Republic Radio	0300	
5075	Caracol Colombia	0300	SS	9810	FEBA, Seychelles	1530	
5124	R. Galaxia, Bolivia	0000	SS	9830	R. Havana Cuba	0100	(USB)
5547v	La Voz de Andamachay, Peru	0200	SS	9830	R. Jordan	1830	AA
5887v	Swiss Radio Int'l, via Brazil	0200		9840	Voice of Vietnam	1230	
5930	R. Prague, Czech Rep (via Slovakia)	0230		9860	R. Australia	0900	
5960	R. Japan via Canada	0100		9860	Swiss R. Int'l, via Fr. Guiana	0400	
5965	R. Budapest, Hungary	0330	EE s/on	9860	R. Sweden	1100	Swed
6000	R. Havana Cuba	0130		9870	R. Austria Int'l	0130	
6010	R. Mil, Mexico	1000	SS	9900	R. Cairo, Egypt	2230	
6015	R. Austria Int'l, via Canada	0530		9977	R. Pyongyang, N. Korea	1100	
6030	BBC via S. Africa	0230		11402	National Broadcasting Service, Iceland	1600	Icelandic
6040	Deutsche Welle via Antigua	0100		11560	R. Cairo, Egypt	1400	AA
6070	CFRX/CFRB, Canada	1200		11570	R. Pakistan	1700	
6080	R. Patagonia, Chile	0900	SS	11580	Trans World Radio, Guam	1500	
6095	Vatican Radio	0250		11620	All India Radio	1100	
6100	R. New Zealand	0800		11650	R. Sweden	1330	
6105	R. Cultura, Brazil	0900	PP	11650	KFBS, Saipan, No. Marianas	1300	RR
6115	R. Union, Peru	0600	SS	11670	R. France Int'l, via Fr. Guiana	0130	SS
6140	Voice of Turkey	0300		11675	R. Kuwait	2200	AA
6150	Caracol Colombia	0330	SS	11690	FEBC, Philippines	1200	VV
6165	Swiss Radio Int'l	0530		11700	R. Pyongyang, N. Korea	2300	
6180	R. Nacional Mendoza, Argentina	0900	SS	11705	R. Japan via Canada	1400	
6195	R. Sweden	0230		11705	R. Nova Visao, Brazil	2300	PP
6250	R. Nacional Malabo, Eq. Guinea	0500	SS	11715	China R. Int'l, via Mali	0300	
6260	V of Greece	0130	GG/EE	11720	R. Bulgaria	2100	
6545	R. Imperial, Peru	0205	SS, s/off	11740	All India Radio	1530	s/on
6570	Myanmar Defence Forces Station	1130	Burmese	11745v	R. Tirana, Albania	0200	
7115	AWR via Slovakia	0730		11750	Voice of Russia	2200	
7125	RTV Guineenne, Guinea	0530	FF	11775	R. Espana Exterior, Spain	1900	
7150	Trans World R., Swaziland	0400	vern	11790	VOIRI, Iran	0030	
7150	R. Vilnius, Lithuania	0000	LL/EE	11800	R. Australia	1300	
7170	ORTS, Senegal	0700	FF	11830	R. Anhuanguera, Brazil	0030	PP
7255	R. Nigeria	0500		11830	Vatican Radio	2250	
7270	R. Oranje, S. Africa	0500		11835	SLBC, Sri Lanka	1100	

Freq.	Country/Station	UTC	Notes	Freq.	Country/Station	UTC	Notes
11845	R. Canada Int'l	2200		15325	R. Canada Int'l	2100	
11850	R. Norway Int'l	1200	Sun	15345	RTV Marocaine, Morocco	1800	AA
11870	FEBA, Seychelles	1500		15365	R. France Int'l	1230	
11885	UAE Radio, Abu Dhabi	2300		15365	R. Australia	2200	
11890	R. Oman	1400	AA	15400	R. Finland Int'l	1330	
11895	R. Japan via Fr. Guiana	0300		15400	BBC via Ascension	1900	
11925	FEBC, Philippines	1300		15435	V of the Great Homeland, Libya	1645	s/on
11925	V of Mediterranean, Malta	1400		15445	Radiobras, Brazil	1200	
11955	R. Nacional, Angola	2200	PP	15475	R. Atlantika, Russia	1300	RR, Tu-Fr
11990	R. Kuwait	1800		15475	Africa Number One, Gabon	2100	FF
12000	R. Ulan Baator, Mongolia	1200	EE/JJ	15490	HCJB, Ecuador	1700	
12005	RTV Tunisienne, Tunisia	1900	AA	15530	R. France Int'l	1230	
12050	R. Cairo, Egypt	2300	AA	15555	R. Pakistan	1600	
12065	V of Russia	1300	s/on	15565	R. Australia	1200	
12085	R. Damascus, Syria	2030		15570	All India Radio	1200	
13605	RS Atlantika, Russia	0200	RR	15575	R. Korea, S. Korea	0030	
13605	R. Australia	1100		15590	Vatican Radio	1345	
13635	Swiss R. Int'l, via Fr. Guiana	0030		15615	Kol Israel	1500	HH
13670	R. Canada Int'l	2200		15650	V of Greece	1400	GG/EE
13675	UAE Radio, Dubai	1630		15675	R. Pakistan	1430	Urdu
13680v	R. Iraq Int'l	1200	AA, irreg.	15675	R. Copan Int'l, Honduras	2300	SS
13730	All India Radio, Bangalore	1300		15770	All India Radio	1200	vern
13750	AWR, Costa Rica	1200	s/on	17490	HCJB, Ecuador	1000	USB
13760	R. Pyongyang, North Korea	0030		17500	RTT, Tunisia	1330	AA
13760	V. of Oromo Liberation, via WHRI	1600	irreg.	17520	V of Greece	1430	GG/EE
13760	R. Philipinas, Philippines	0200		17575	Kol Israel	1100	
13805	R. Denmark via Norway	1530	DD	17605	R. Netherlands via Bonaire	1830	
13860	INBS, Iceland	2300	Icelandic	17620	R. France Int'l	1600	
15009	V of Vietnam	1330		17630	Africa No. One, Gabon	1430	FF
15050	RFPI, Costa Rica	1600		17655	R. Ukraine Int'l	2330	
15084	VOIRI, Iran	2200	Farsi	17670	Swiss Radio Int'l	1500	
15095	R. Damascus, Syria	2030		17740	R. Finland Int'l	1430	
15130	R. Veritas, Philippines	1130		17745	R. Algiers, Algeria	1930	
15168v	R. Tahiti	0300	FF/TT	17775	R. Romania Int'l	1300	
15175	BSKSA, Saudi Arabia	1200	AA	17810	R. Japan	2300	
15190	R. France Int'l	2300	SS	17820	R. Canada Int'l	1300	
15220	Golos Rossii	1200	RR	17870	R. Exterior Espana, via Costa Rica	2200	SS
15235	V of Great Homeland, Libya	2000	AA	17870	RAI, Italy	1730	II
15240	R. Sweden	1330		17895	Qatar Broadcasting Service	1400	AA
15265	Radiobras, Brazil	1700		17900	R. Portugal	2000	PP
15270	HCJB, Ecuador	1930		17905	RFPI, Costa Rica	1900	USB
15325	R. Gazeta, Brazil	2300	PP	21455	HCJB, Ecuador	1330	

ICOM®



THE NEXT GENERATION

For more
information
about ICOM's
"Next Generation"
radios call
(206) 450-6088

ICOM America, Inc.
2380 116th Ave. N.E.
Bellevue, WA 98004.

 ICOM®

© 1995 ICOM America, Inc. AM-2899. The ICOM logo is a registered trademark of ICOM, Inc.

PIRATES DEN

BY EDWARD TEACH

FOCUS ON FREE RADIO BROADCASTING

Pirate radio activity seems a bit below the level it was this time last year. But that's not to say there's nothing happening. I guess maybe the previous surge was just that, and what we've got now is closer to the average. Let's see what's in the file:

Vox America is a new one, at least to me. It was picked up by Dick Wilkie, in Ohio at 2315 on 7408 with fake commercials, rock 'n' roll, and mentioning a power of 100 watts. The address they gave was P.O. Box 3913, Schnectady, NY 12303.

Dick also had He Man Radio on 6955 USB at 0100 with what they said was a test from somewhere in Ohio. The program used the "River Kwai" theme music.

Dick Pearce, in Vermont logged Radio Is Not Radio on 6955.05 USB at 2213. He reports that station IDs seemed to be broadcasted in foreign languages, then there was classical violin music and numerous IDs "Radio is not Radio" with Hispanic or Italian accents. Dick says after the station signed off there was a lot of "open-air" discussion of the program. No address announced, or at least none was caught.

Real Radio USA was heard by Pearce on 6955.1 USB at 2130. The program was announced as a special broadcast and mentioned "Real Radio USA is not Andy Yoder." Also announced were two phone numbers listeners could call to get a free T-shirt. Dick says the program was tough to copy, and he's not sure whether this was meant as straight or was a put-on. They also announced an address of Rural Route 1, Box 15A, Belfast, NY, which Dick parenthetically notes he doubts is real.

Right after Real Radio USA signed off, Fake Radio USA came on the same frequency at 2200. They opened with a lullaby and said they were "happy to QSL." Dick says the address announcement was "reverberated to oblivion," so he guesses the announcer wasn't serious. The operator also mentioned "WJTA is not John Voight and John Voight is not WJTA" several times. (All this "not" stuff lately really gives me pains in the head! I wish pirates would either cut it out or someone would explain it to me.)

An apparent new one is KXXX, heard by Don Sebesky in North Carolina at 0120 on 6955, calling itself "extreme pirate radio" and featuring hosts "Major Spook" (Spock?) and "Reverend X." It included a lot of rock music, fake commercials, comedy sketch, etc. Don says he didn't hear any address announced.

KDED was logged in Pennsylvania by George Roberts, who had them at 0130 on 6965 USB, including Grateful Dead songs and talking about same. They signed off just shortly after 0200.

Roberts also logged WKND at 2230 on

6955 LSB featuring Radio Animal and Pirate Mike doing parodies of other pirate stations, plus for the A*C*E club and a talk promoting 1.6 MHz as an area for pirate operations. (1.6 MHz is now part of the newly expanded AM broadcast band.)

Laser Hot Hits (a Canadian) was heard again by Wilkie, on 6955 USB at 0018 tune-in, carrying rock music, station jingles and sound effects, mention of "...we keep on rocking."

Dick says this station had one of the strongest signals he's heard from a pirate in some time.

Pearce had Radio Garbanzo on 6955 USB at 2218 announcing it was "live from an interstate highway in the northeast." Dick suspects this was a repeat broadcast because the content included things he's seen reported earlier. Even so, Dick judges this as very well done.

George Roberts checks in with a log of Radio Azteca on 7412 at 1315, not an hour when most pirates flip on their rigs. The show, announced as No. 14, featured Bram Stoker's top 10, listeners' letters, fake (and funny!) commercials, and little "bits and pieces of this and that scattered throughout."

Pearce logged Up Against the Wall Radio on 6955 USB at 0057 and notes it was the seventh time he's heard "Owsley and his always excellent show," featuring a mix of music and humor. He offered extra goodies with the QSL if listeners could tell him what was on the flip side of 1950s era 45 rpm record he played. Sign-off with the usual "oogah" sound effect.



WLIS went into the Pearce log at 2015 on 6954, though Dick says the copy on this one was really tough. The show was called, "The feature on pirate interval signals, Part III" and included IDs of WKNB, The Crooked Man, and others. Announced as "interval signals without the attitude."

That wraps it for this time. Thanks to all those who checked in this month. I'd like to hear from more of you though. I'm always in need of copies or samples of pirate station QSLs, or even photos. How about it? I'll catch you all again next month!

#38



Solid
Rock
RADIO

Date: 10-17-93
Time: 00:14 - 00:29 UTC
Frequency: 7465 AM KHZ
Reporter: M. LECLERC

REG'S < HELICOPTER HT-40
KENWOOD TS 120 S
INVERTED VEE'S

We're Glad You Caught Our Signal
And Not Us!!

Dr. Love

From out of the past comes this QSL from Solid Rock Radio, received by Mike Leclerc a couple of years ago.

LOOK

AND SEE WHY

U.S. SCANNER NEWS

Is the ONLY national monthly magazine devoted entirely to the hobby of VHF-UHF monitoring. **NO Shortwave Broadcast!!**

Each Month You Get:

- FCC Monthly Updates For ALL States
- Outstanding Feature Articles
- In-depth, unbiased reviews
- Accurate frequency information
- The latest FCC actions
- Helpful scanning and technical hints
- Plus regular monthly columns

**AVERAGE
50+ PAGES
PER MONTH**

**REGULAR
MAGAZINE
FORMAT**

1-800-890-6999

Call Now With Your Credit Card Or Send a Check or Money Order To:
U.S. Scanner Publications

**PO Box 14923
Portland, OR 97214-4923**



- One Year for only \$20.00. (Other Countries \$34.00 US funds)
- Two Years for only \$35.00. (Other Countries \$64.00 US funds)
- Three Years for only \$49.00. (Other Countries \$92.00 US funds)
- Sample Copy \$3.00 1ST Class. (Other Countries \$5.00 US funds)

Name _____

Address _____

City, State, Zip _____

MC/Visa/Discover # _____ Expires _____

COMMUNICATIONS FOR SURVIVAL

You've Been Stepped On...Say Again

A summer and fall radio phenomena will cause a dispatcher major headaches when trying to stay in touch with mobile and portable units a few miles away. August and September are the best months for the worst in two-way radio reception, thanks to local weather conditions. Mobile and portable equipment operated by emergency communicators in the field also can get "stepped on" from interference coming over their local VHF or UHF channel.

"Unit 27, quit horsing around. You left just 10 minutes ago, and there is no way you are 300 miles away," barks Seals ambulance dispatcher Tom Powell on his assigned 155.160 MHz frequency. "Hey, dispatcher, you are not talking to Seals ambulance—this is Life Flight Unit 27 sitting on the pad in Phoenix...."

Freak unpredictable co-channel interference with another emergency squad hundreds of miles away is relatively common on low-band frequencies between 30 MHz and 50 MHz. The problem is caused by ionospheric skip at the peak of the solar cycle and intense sporadic-E skip that occurs every year in June and July. However, skip conditions seldom occur on 155 MHz, and are non-existent on the 465 MHz and 857 MHz bands. We also are at the bottom of solar cycle 23, so low-band ionospheric skip is not a common occurrence on emergency frequencies.

The big problem with co-channel interference in August and September is tropospheric ducting. This is a weather phenom-

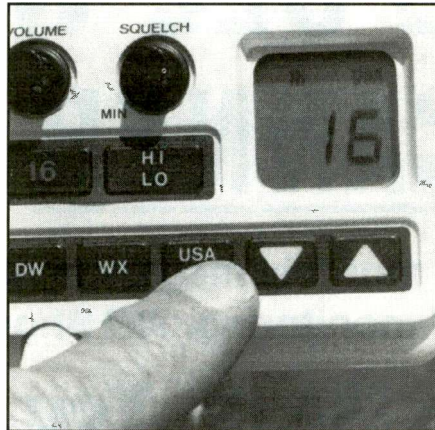

Channel 16 shore station calls can be heard 400 miles away because of local weather conditions.

ena that has no bearing on the solar cycle or the ionosphere. Tropospheric ducting causes low-band, high-band, UHF, and 800 MHz signals to travel hundreds of miles farther than what emergency communications system were planned for. Nothing can be done to prevent tropospheric ducting, but a better understanding of this atmospheric phenomena will help you live with this summer/fall yearly headache.

VHF and UHF land mobile radio signals travel approximately 50 miles from base and mobile units, and maybe twice that distance when the base station or repeater is located high up on a mountain or tall skyscraper. You can calculate the typical "4/3

radio horizon distance" by looking up your base station antenna elevation, doubling the elevation in feet, and then taking the square root of this as base station range to the horizon in miles.

EXAMPLE:

Paramedic transmitter/antenna height = 5,000 feet on a mountain
Double this for a total of 10,000 feet
Square root of 10,000 feet=100 miles, radius, radio coverage

EXAMPLE #2:

Ambulance company with 40-foot VHF antenna tower
2 x 40 feet=80 feet
Square root of 80 feet=9 miles radius

When tropospheric ducting moves in over a widespread area of the United States, VHF and UHF radio waves will travel well beyond the normal line-of-sight range, and carry as far as the widespread tropospheric duct extends.

Tropospheric ducting of radio waves occurs within high-pressure cells that form and stall over the United States. This creates a temperature inversion because of the sinking air (called subsidence) within the high-pressure system. An inversion of 10 degrees or greater over cool surface air will appear as a stratification of trapped smoke that literally hangs on the horizon. A cell of high pressure could trigger an inversion layer that would "cap" 10 or 15 states at



Harbor patrolman also will experience interference on marine VHF because of local tropo conditions.



This public safety dispatcher dreads summertime tropo interference.

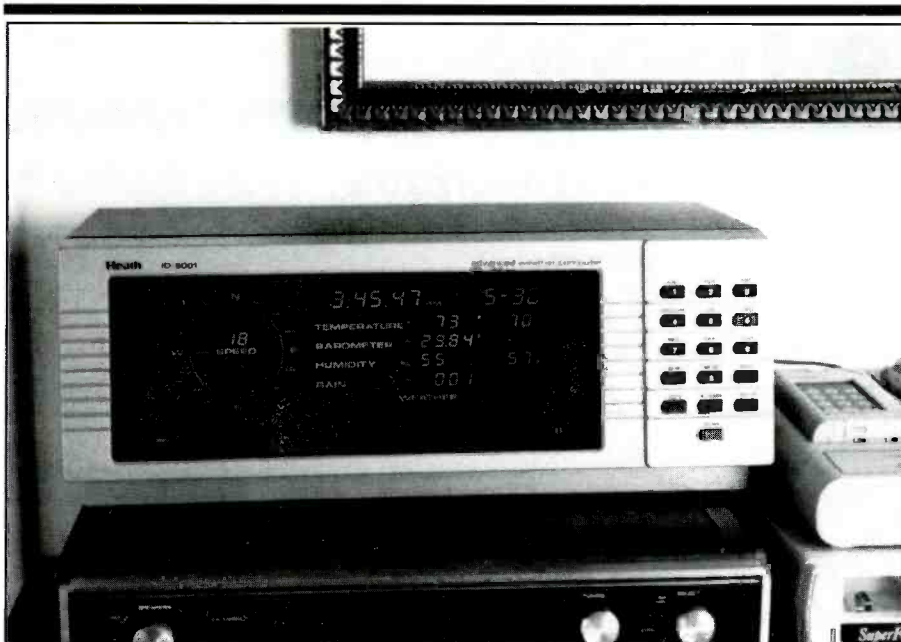

Watching a home weather station for steady high pressure is a good way to predict tropo conditions

a time under stable weather conditions in August and September. VHF and UHF signals get caught up in the inversion, and could travel up to 800 miles away. The condition will last as long as the inversion layer remains undisturbed; this usually is a five- to eight-day weather phenomena.

Many times emergency base station systems on elevated antenna towers atop a building are more affected by the inversion layer than UHF or trunking system antenna sites atop mountains. The inversion layer can be so strong that tunnel signals only enter it from ground level up to 1,000 feet, and no higher. In hilly terrain, emergency responders actually can see when they are within the inversion layer, feel the dramatic rise in temperature, and experience severe two-way radio and biomedical interference from other stations hundreds of miles away.

When a high-pressure system is forecast over an area and the dispatcher detects one of those hot, windless, smoggy days while driving into work, a good procedure is to turn off the CTCSS switch to monitor all traffic on the channel regardless of sub-audible tone. This should be done at the beginning of each shift to see how bad the distant station interference is, and get a feel for who else may be on "your" channel. Keep in mind: "your" channel is really a shared resource. Just because you don't hear any other service transmitting on the frequency does not necessarily mean you have an open channel.

When listening without squelch decode turned on, learn to identify other stations sharing the same frequency and their mobile unit numbers. If you coincidentally

share the same mobile identification numbers on the same frequency, it's time to get together with that distant agency and try to work out special identifiers to differentiate your calls from their calls.

When your own units are being "covered" by another station on the same frequency, the sound you will hear is called "doubling." You will hear an oscillation that corresponds with the difference in the two incoming frequency-modulated (FM) signals. In rare cases of intense tropospheric ducting, more distant units from another emergency group actually can override local handheld stations, and this is called "capture effect." If you operate with your squelch decode circuit switched in, not only will you not hear the tell-tale signs of "doubling," but you will miss altogether the fact that another unit using a different CTCSS tone actually is covering up one of your handheld stations. *Keep your base station microphone's CTCSS decode button pushed down to listen to your channel in open squelch.* On mobile units, take your mobile microphone out of the holder to listen in *open channel*. On handheld units, switch out of squelch decode and listen to your frequency *open channel*. This way, you can tell what's going on at a distance.

Tropospheric ducting should subside in October when the weather gets colder, and stable high-pressure systems move out of your continent. Until then, learn to expect severe interference on your channel when a high-pressure system hangs over your area for a few days, creating hot, windless days and plenty of interference on the channel that is normally quiet from distant stations. ■

SURVEILLANCE

FM TRANSMITTERS MINI (KITS)

- 3-VOLT FM XMTR, up to 300 ft. indoors, 1500 ft. outdoors
- PHONE XMTR, range to 500 ft., uses phone-line power
- Sound-Activated XMTR, range to 500 ft.
- 2-STAGE XMTR, 9-Volt, very powerful

All above require simple soldering at 2 to 4 places. **\$29.95****

TELE FM WIRELESS MONITORING SYSTEM. (Kit) **\$99.00***

TELE CALL FORWARDER. Transfers incoming calls. **\$99.00***

CALLER ID. Registers incoming number. **\$99.00***

TEL REGISTER WITH PRINTER. Records dialed number, duration, and prints record. **\$139.00***

12-HOUR LONG-PLAY RECORDER. Modified Panasonic. Records 6 hrs. on each side of 120 tape (supplied). Compatible with VOX and Tel Rec Adapter. **\$119.00***

VOX VOICE-ACTIVATED SWITCH. Makes recorder self-activating with voices or other sounds. **\$28.50****

TELE RECORDING ADAPTER. Records incoming and outgoing calls. **\$28.50***

TELEPHONE SCRAMBLERS. Over 4,000 separate codes. **\$199.00***

VOICE CHANGER. Changes man's voice to lady's and vice versa. **\$49.00****

For Shipping & Handling add *\$5.00 and **\$2.00 per item. Colo. residents add sales tax. Mail Order, VISA, M/C, COD's o.k. Inquire for dealer prices. Free catalog.

MUCH, MUCH MORE — OUR 25TH YEAR!

TOLL FREE 1-800-926-2488

A.M.C. SALES, INC.

193 Vaquero Dr., Boulder, CO 80303
Tel: (303) 499-5405, Fax: (303) 494-4924
Mon.-Fri. 8 a.m.-5 p.m. Mtn. Time

CIRCLE 79 ON READER SERVICE CARD

FINALLY!

High performance scanning with Windows™ is now possible!

With the new Scan*Star™ for Windows you can use your PC to drive your radio at full speed AND run other programs at the same time!

- o Scan with up to 10 radios at the same time.
- o Uses new Scanning Engine™ technology to solve Windows real time performance problems.
- o Browse and import directly from DBASE files such as Grove or Percon FCC databases.
- o Spectrum analysis on R7100, R9000, AR3000, OS456, OS535, and AR8000. EEPROM access on AR8000.
- o Use any serial port, even COM3/4 when COM1/2 are in use. Will work with 4 and 8 port cards too!
- o Scan by PL/DPL tone with OS456, OS535 or DC440.
- o Scan multiple groups, banks and search ranges all at the same time! Alarms for priority channels.
- o Highest performance. No frequency restrictions.
- o Comprehensive reporting & logging. Logs DTMF.
- o Exchange data with other file formats. Read and write channel memory on selected radios.

Equipment Supported:

OS456, OS535, R7100, R7000, R9000, FRG9600, DC440, AR3000, AR8000

System Requirements:

IBM PC 386/486/586 with 4 MEG ram, hard disk, VGA, mouse, serial ports. Windows 3.1 or 95. Cables and interfaces for radios may also be required.

Scan*Star for Windows **\$159⁹⁷**

Commercial Edition [DOS] **\$129⁹⁷**

Professional Edition [DOS] **\$79⁹⁷**

Add S/H & TAX. Visa, MC, AMEX cards accepted. No COD.

1-408-926-5630

Signal Intelligence
The Leader in PC
Radio Scanning
PO BOX 640891
San Jose CA 95164

FREE DEMO
Download from Scan*Star BBS
1-408-258-6462
URL: <http://www.scanstar.com>

CIRCLE 50 ON READER SERVICE CARD

Really Long-Wire Antennas

Long-wire antennas are any of several types of resonant and non-resonant wire antennas. Any given size long-wire antenna may be both resonant and non-resonant, depending upon the operating frequencies used. The resonant long-wire antennas are resonant on the fundamental band, plus the harmonically related bands.

There is an issue over terminology regarding long-wire antennas. A lot of people (including me in the past) improperly use the term "long-wire" to refer to any random-length antenna. A popular SWL and ham antenna for HF bands is the end-fed wire antenna that is greater than a quarter-wavelength long. Such antennas can be impedance-matched to transmitters and receivers with a simple form of an L-section antenna coupler. But they aren't really long wires. A true long-wire antenna is an antenna that is many wavelengths long, or to be a little more correct, an antenna that is more than two wavelengths long.

Figure 1 shows the classic non-resonant long-wire antenna. It consists of a wire radiator at least two wavelengths long, and may be many wavelengths. The specific length is not critical, but it must be greater than two wavelengths at the lowest frequency of operation anticipated. If you have a 150-foot long wire, it will work on the HF bands above 6.6 MHz. In most installations, the wire for the radiator element is #12 or #14 copperweld or hard-drawn copper wire. I have successfully used both #12 and #14 house wiring wire with moderate success, but because it is solid (not stranded) it is not the best material. Stranded wire lasts longer in the wind because solid wire fatigues and breaks quicker.

The long-wire antenna is capable of providing directivity and gain over a dipole, and a low angle of radiation (which is great for DX!). These advantages are found only when the antenna is many wavelengths long, and only occurs easily on typical HF antennas in the 15 through 30 MHz bands (although, for those with real estate, patience and money, long wires down to VLF can be built).

The long wire is end fed, and, therefore, has a high impedance. Because of this fact, it is necessary to use an antenna tuner between the low-impedance receiver antenna input (usually 50 ohms impedance) and the antenna feedpoint.

The long wire usually is installed horizontally like a dipole. The ends are supported (dipole-like) from standard end insulators and rope. Some people, for special and possibly invalid reasons, sometimes will install a long wire with one end elevated about 30 to 40 degrees in order to posi-

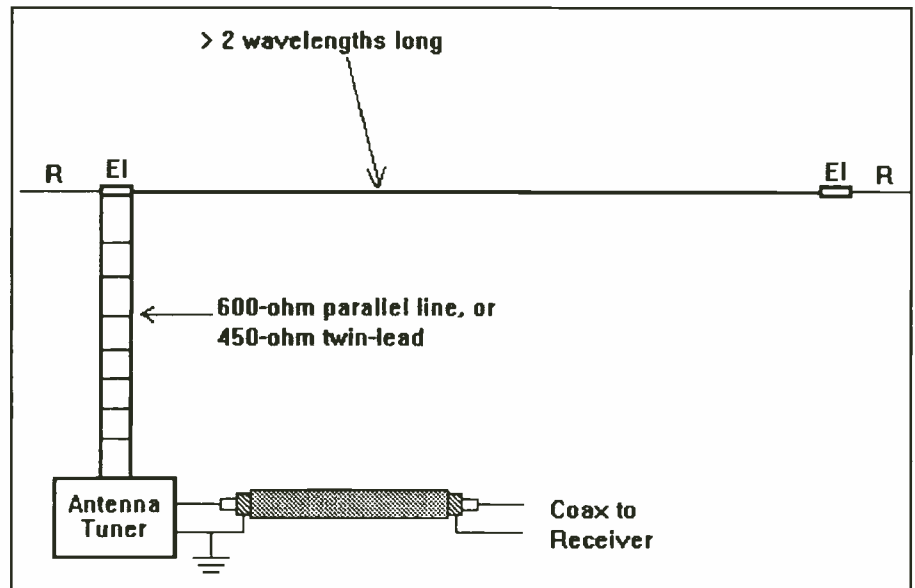

Figure 1. Long-wire antenna.

tion one of the main lobe pair along an axis that is tangent to the horizon. The standard arrangement produces a low angle of radiation for long-distance DX reception.

The long-wire antenna is capable of wideband operation. Gain and directivity are at least "satisfactory" for any frequency over an octave frequency range (2:1). Furthermore, it will at least radiate some power (or receive) at other frequencies for which the antenna is greater than, or equal to, a half-wavelength. Thus, the long wire designed for 30 MHz will behave well down to 2 MHz, even though low-frequency operation does not exhibit the same properties as the higher frequency operation. For these lower frequencies, the antenna becomes more like a random-length antenna.

What does "many wavelengths" mean? That depends on what you want the antenna to do. The long wire has gain relative to a dipole, but only as length is increased relative to wavelength. Although a two-wavelength antenna has only a slight gain over a dipole, the longer the antenna the greater the gain (five to seven wavelengths is a common design goal for long-wire builders). It is possible to obtain gain figures greater than a three-element beam using a long wire, but only nine- or 10-wavelength antennas qualify.

What does this mean? One wavelength is 984/FMHz feet, so at 30 MHz one wavelength is about 32.8 feet; at 4 MHz one wavelength is 246 feet. In order to meet the "two wavelengths" criterion the 30-MHz antenna need only be 66 feet long, while a 4-MHz antenna would be 492 feet

long! For a 10-wavelength antenna, therefore, we would need 326 feet for 30 MHz, and for 4 MHz it is 2,460 feet long. Perhaps now you can see why the long wire is not more popular!

The length of a resonant multiple wavelength long wire is found from:

Where: L is the length in feet, N is the number of wavelengths (N is an integer 2, 3, 4 ...), and F MHz is the design frequency in MHz.

Of course, there are always maddening people like my friend (now deceased) John Thorne, K4NFU. He lived near Austin, Texas, on a multiacre farmette that has a 1,400-foot property line along one side. John installed a 1,000-plus-foot long wire and found it worked excitingly well. He fed the thing with homebrew 450-ohm parallel ("open-air") line and a Matchbox antenna tuner. John's long wire had an extremely low angle of radiation, so he regularly worked ZL, VK and other southeast Asia and Pacific basin DX with only a few watts of power (he was a QRP low-power freak).

Oddly enough, John also found a serious problem with the long wire that textbooks and articles rarely if ever mention: Electrostatic fields build up a high-voltage DC charge on long-wire antennas! Thunderstorms as many as 20 miles away produce serious levels of electrostatic fields that can cause a buildup of electrical charge on the antenna conductor. The electric charge can cause damage to the receiver's input circuitry. John solved the problem by using a resistor at one end to ground. The resistor is composed of 10 to 20 series connect-

ed 1-megohm non-inductive carbon resistors rated at 2 watts each. This resistor bleeds off the charge, preventing damage to the receiver.

A common misconception about long-wire antennas regards the normal radiation pattern of these antennas. I have heard ham operators on the air claim that the maximum radiation for the long wire is broadside (i.e., 90 degrees) with respect to the wire run, or in-line with the wire run. Neither is correct, although ordinary intuition would seem to indicate one or the other. The reason for the latter assumption is that the pattern for a very long wire (> 7) in free space is a cone along the antenna wire axis.

Figure 2 shows the approximate radiation pattern of a long wire close to the Earth's surface. There are four main lobes of radiation from the long wire (A, B, C and D). There also are two or more (in some cases many) minor lobes (E and F) in the antenna pattern. The minor lobes are because of the fact that the antenna acts similar to a series of half-wavelength dipoles arranged in an end-to-end array. The difference is that the end-feeding of the antenna causes a loss of current level along the line length because of ohmic resistances (minor effect) and radiation from the earlier sections of the wire (major effect). The reduction of current amplitude causes the field strength at distant points to be complicated and far from ideal. The radiation angle with respect to the wire run is a function of the number of wavelengths found along the wire. Also, the number and extent of the minor lobes also is a function of the length of the wire. In freespace, as the wire becomes longer the lobes resolve into a single lobe close to the wire along the length of the antenna.

The reception properties of antennas are reciprocals of the transmission properties, which is another way of saying that the antenna works on receive much like it works on transmit. Although not a violation of the law of reciprocity, some observers believe that the long wire will act better on receive than on transmit for certain frequencies. The basis of this claim is that for certain frequencies the long wire acts like a large number of half-wavelength antennas in series, so when it intercepts a broad wavefront a phenomenon similar to diversity reception occurs. If the wavelets induced into the antenna line at different points tend to add in-phase at the feed-point, then it is possible for the antenna to exhibit what appears to be a little greater gain on receive than on transmit.

It is possible to use either voltage feed or current feed for the long-wire antenna. However, on a current-fed long wire, the transmission line must be connected at a current loop (i.e. maxima or "antinode") for the frequency of operation, and coaxial cable transmission line can be used. Although it sounds convenient, this practice is not

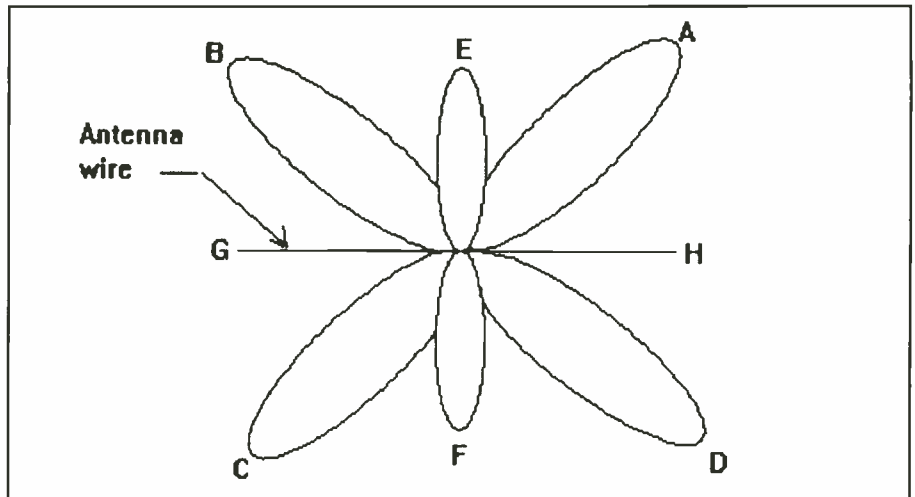

Figure 2. Pattern for long-wire antenna (varies with length and frequency).

the best in all cases because of the fact that the current antinode becomes a current node (minima) at even harmonics of the design frequency. For this reason, we do not usually current feed the long-wire antenna, but rather voltage feed it at one end.

Either parallel transmission line (sometimes called "open-air" line or some such name), or 450-ohm twin-lead can be used to feed the antenna. The transmission line is excited from any of several types of bal-

anced antenna tuning units. Alternatively, a standard antenna tuning unit designed for coaxial cable can be used if a 4:1 balun transformer is used between the output of the tuner and the input of the feedline.

Conclusion

In the next installment of this column, we will look at some additional long-wire antennas. ■

THE NEW STANDARD FOR ANTENNA ACCESSORIES

Alpha Delta Model DELTA-C Antenna Hardware Kit

Don't build Your next dipole without one! Designed for convenience and equipment protection with a built-in replaceable Model SEP ARC-PLUG® Static Electricity Protector.

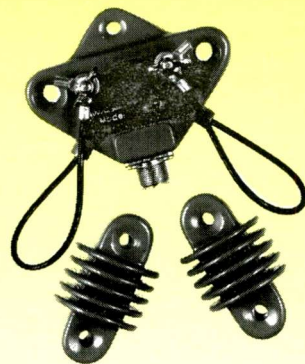

- The SEP protector "bleeds off" slow rising static electricity charges and routes them harmlessly to ground. Far more rugged than DC grounded baluns or chokes, which can be "popped" by static charges.

Static charges are developed from thunderstorms, high wind driven snow or desert sand and have been measured to several thousand volts. They can even puncture unterminated coax cable.

- The DELTA-C center insulator and end-insulators are fabricated with an extremely rugged UV and RF resistant material called DELTALLOY. It is so tough you can drop it off a roof with no damage. You no longer need to look for ceramic or glass insulators.

- We use only stainless steel hardware in the center insulator for salt air and other corrosive environments. All internal connections are hard soldered instead of press fit for highest reliability.

- The DELTA-C kit is ideal for dipoles, inverted-Vs, zepps and other wire antennas. It is designed to be fed with either coax or balanced line. The hardware will take either type. It is rated for full transmit power and is also perfect for all kinds of SWL receive antenna applications.

Alpha Delta Model DELTA-C antenna hardware kit: center insulator, 2 end-insulators, and Model SEP ARC-PLUG® Static Electricity Protector.....\$29.95 ea.

Separate Model DELTA-CIN end-insulators (10 piece min. for direct orders).....\$1.00 ea.

At your Alpha Delta Dealer or add \$5.00 for direct US. orders. Exports quoted.

ALPHA DELTA COMMUNICATIONS, INC.



P.O. Box 620, Manchester, KY 40962 • (606) 598-2029
fax • (606) 598-4413

Radio—"The Original Information Superhighway"

—Alpha Delta Makes it Better

27 MHz COMMUNICATIONS ACTIVITIES

Uniden has announced a new low-cost CB targeted at the entry-level CB user. The new Pro 501XL, according to Uniden's news release, "is small enough to fit almost anywhere and incorporates technological advances that ensure the same quality and performance of larger units."

The Pro 501XL is downright microscopic—just 4-1/2 inches wide by 6-3/4 inches deep by 1-3/8 inches high. It features 40 channels AM, built-in noise limiter, and a squelch control. Channels are selected by using up/down buttons, rather than a rotary tuning knob.

The price is certainly right: the suggested retail of the Pro 501XL is \$59.95, and the Pro 501AXL, with a magnetic-mount antenna and cigarette lighter plug, carries a suggested retail price of \$79.95. I haven't seen or heard one of these radios, but you might want to check one out if you're looking for a low-cost, compact rig.

Newsletter Covers Jamborees

Also worth checking out: a monthly newsletter, *C.B. News Voice*, published by Charles Allen of Bloomington, Indiana. First published in January 1989, this newsletter covers CB jamborees and coffee breaks, telling when and where they will be held, and who to contact for additional information. Some of the events sound like great fun with real down-to-earth folks.

Single copies of *C.B. News Voice* are \$1.75, and a full year's subscription is \$13.75. For additional information about this publication, write Charles H. Allen, Editor and Publisher, 719 N. Grant St., Bloomington, IN, 47408-3649, or call him at (812) 336-7387.

AIC Net Announced

A large envelope arrived in the mail not long ago containing a really fancy certificate with my name on it. For a moment, I thought I had been elected to the New York Stock Exchange, or maybe the Supreme Court, but it turned out to be something even better—the American International Club (AIC) had made me an honorary member. I've joined a number of organizations in my time, but I've never seen a finer membership certificate. Thanks, guys!

AIC, which has members from all over, will be holding a sideband net on the third Saturday of every month at 11:30 pm. For more information about the net channel and how to get one of those really impressive membership certificates, write: American International Club, P.O. Box 720811, Queens, NY 11372. Incidentally, AIC has a column in *C.B. News Voice*.



Members of the American International Club get this handsome certificate. Reproduction at reduced size doesn't do it justice, though.

In addition, AIC is starting a QSL swap department. You can find out more about it by writing and sending five of your QSL cards to: David, AIC-532-NC, QSL Swap Department, American International Club, 1530 E. Dixon Blvd. #1, Shelby, NC 28152.

Firestik Innovation

The bright folks at Firestik Antenna Co. have come up with an interesting development: the Fire-Ring, a coax cable with its own integral ring connector. It's just the ticket for connecting coax to any stud-mounted antenna. No more messing with crimp-type lugs and ring terminals. Fire-Ring installs in a snap, and it's weather-tight. Suggested retail price for the 18-foot version is \$12.49; the 9-footer, which is just right for motorcycles, is \$11.99.

Firestik also publishes a very nice 38-page guide to their CB antennas and accessories that includes some antenna tuning tips. You can get one for free by writing to: Rick G. Vincent II, Firestik, 2614 E. Adams St., Phoenix, AZ 85034-1409.

Gizmotchy Strikes Again

A while back, a reader sent in a picture of the Charles Gizmotchy antenna. It looked like an interesting design, and I asked in this column if anyone knows whether the Gizmotchy antenna still is made.

Before long, I got a note from Jane Charles of Charles Radio Co. telling me that the Gizmotchy antenna still is being manufactured and is available to CBers. Retail price is \$299.95, and the antenna is sold

through some dealerships. What I find intriguing about this antenna is it looks like a dual-polarity beam that someone cut the bottom elements off of, then bent the horizontal elements down at an angle. While I haven't actually tried it, it looks as if this antenna could offer both vertical and horizontal polarity in a configuration that would work with a chimney mount or a roof tower.

Charles Radio also manufactures the Power Booster, another set of director elements that adds about 4 dB of forward gain to the antenna. The Power Booster retails for \$79.95, and it is designed so that you can add two or three Power Boosters to a single Gizmotchy antenna—that would be about 12 dB of forward gain—for a really punchy signal.

To order a Gizmotchy antenna or to get additional information, write to: Jane Charles, Charles Radio Co., 6836 West Pearl City Road, Freeport, IL 61032, or call (815) 235-7733.

From the Mail Bag

Klaus Spies writes from Illinois to tell of an interesting incident that happened recently:

"I was driving home and talking to a friend via amateur radio when I saw a three-car accident with injuries. In spite of the fact that ham radio is (at least in part) established to provide emergency communications, neither my friend nor anyone else on the other ham repeaters I could reach were willing to help. I had to pull off to the side of the road, connect my CB antenna (usu-



"The Largest Dealer of Scanners in the World"

SCANNER WORLD, USA®

10 New Scotland Ave., Albany, NY 12208 • 518-436-9606

MODEL: FB-911

FIRE BOX PHONE

\$45.99 (\$5.50 Shipping Each)



13 memory phone, 3 direct access emergency memories, auto redial, ringer on/off, top light flashes when telephone is ringing, tone/pulse switchable, desk/wall mount, front door closes for authentic fire box appearance. FCC approved. Size 16"H x 8 1/2"W x 7"D.

We also have the PB104, dark blue POLICE PHONE BOX for only \$45.99 (\$5.50 Shipping).

GM-1™ GLASS MOUNT SCANNER ANTENNA

Frequency coverage 25-1200 MHz — only 22 inches tall. No holes to drill — includes contact glue pads for easy installation. Complete with 17 foot cable. Motorola connector, and mounting hardware. Swivels to vertical position — performance unaffected by moisture on the window.

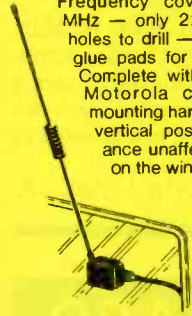

Made in USA.

SPECIAL \$39.99 (\$4.00 Shipping Each)

GLASS MOUNT ANTENNAS FOR TRANSCEIVERS

Includes mounting kit and cable. Low band, High band and UHF band includes PL259 connectors. 800 cellular band antenna includes TNC connector.

- GM-27 27 MHz Low Band for CB... \$39.99 (\$4.00)
- GM-155 144-174 MHz High Band... \$39.88 (\$4.00)
- GM-450 450-470 MHz UHF Band... \$39.99 (\$4.00)
- GM-800 Cellular Telephone Band... \$34.99 (\$4.00)

- CB Radios **In Stock**
- Two-Way Radio Batteries **In Stock**
- Scanner Antennas **In Stock**
- Power Supplies **In Stock**

SCANNER ACCESSORIES

- | | | | |
|-----------|-------|---------|-------|
| BCAD70 | 14.99 | BP4 | 24.99 |
| BCAD100 | 14.99 | BP55 | 16.99 |
| BCAD140 | 14.99 | MA917 | 26.99 |
| BCAD580 | 16.99 | MA518 | 14.99 |
| BC003 | 7.99 | ESP25 | 16.99 |
| BC002 | 59.99 | GRE8002 | 79.99 |
| PS001 | 12.99 | GRE-HH | 54.99 |
| UA502A | 12.99 | GRE9001 | 89.99 |
| BP205/200 | 34.99 | GRE3001 | 62.99 |
| BP701 | 16.99 | FBE | 5.99 |
| VC001 | 12.99 | FBSW | 5.99 |

★ ALL MERCHANDISE NEW, IN FACTORY SEALED CARTONS ★

UNIDEN BEARCAT BC200XLT

\$224.99 (\$8.00 Shipping)



Digital programmable 200 channel hand held scanner with raised button keyboard for easy programming of the following frequency ranges: 29-54 MHz, 118-174 MHz, 406-512 MHz.

809-956 MHz. * Features include: Scan delay, memory backup, key pad lock, sidelit liquid crystal display, channel lockout, 10 twenty channel banks, direct channel access, automatic search, one full year factory warranty, 10 priority channels, Ni-Cad battery pack, AC adapter/charger, flexible rubber antenna, carry case are all included. Size is 2-11/16"W x 1-3/8"D x 7-1/2" high. (*Excludes Cellular) #CC-008 Heavy Duty Leather Carry Case **\$27.99**

RADIO SCANNERS

- | | | |
|--------------------|----------|--------|
| BEARCAT BC60XLT | \$109.99 | (7.00) |
| BEARCAT BC70XLT | 114.99 | (7.00) |
| BEARCAT BC80XLT | 219.99 | (8.00) |
| BEARCAT BC100XLT | 159.99 | (7.00) |
| BEARCAT BC120XLT | 169.99 | (7.00) |
| BEARCAT BC142XL | 83.99 | (6.00) |
| BEARCAT BC144XL | 89.99 | (7.00) |
| BEARCAT BC147XL | 99.99 | (7.00) |
| BEARCAT BC148XLT-1 | 104.99 | (7.00) |
| SPORTCAT SC150B/Y | 174.99 | (8.00) |
| BEARCAT BC178XLT | 149.99 | (7.00) |
| BEARCAT BC200XLT | 224.99 | (8.00) |
| BEARCAT BC220XLT | 259.99 | (8.00) |
| BEARCAT BC350A | 129.99 | (7.00) |
| BEARCAT BC400XLT | 93.99 | (7.00) |
| BEARCAT BC560XLT | 109.99 | (7.00) |
| BEARCAT BC580XLT | 194.99 | (7.00) |
| BEARCAT BC700A | 199.99 | (7.00) |
| BEARCAT BC760XLT | 249.99 | (7.00) |
| BEARCAT BC800XLT | 229.99 | (8.00) |
| BEARCAT BC855XLT | 149.99 | (8.00) |
| BEARCAT BC860XLT | 199.99 | (8.00) |
| BEARCAT BC890XLT | 284.99 | (8.00) |
| BEARCAT BC2500XLT | 369.99 | (9.00) |
| BEARCAT BC8500XLT | 369.99 | (9.00) |
| BEARTRACKER BCT2 | 149.99 | (7.00) |
| BEARTRACKER BCT7 | 209.99 | (7.00) |
| COBRA SR900 | 99.99 | (7.00) |
| COBRA SR901 | 74.99 | (6.00) |

BOOKS

- | | |
|----------------------|-------|
| Scanner Master | 29.95 |
| Covert Intelligence | 8.95 |
| Air Scan Directory | 14.99 |
| Betty Bearcat | 5.99 |
| Top Secret (8th) | 18.99 |
| Covert Techniques | 9.95 |
| Tomcat's Big CB | 13.95 |
| World Radio | 18.99 |
| Survival Directory | 6.95 |
| Rail Scan | 7.95 |
| Monitor America | 24.99 |
| Police Call | 9.29 |
| Scanner Modification | 17.99 |

Uniden®/Bearcat BC-142XL 10 Channel Base/Mobile Programmable Scanner

\$83.99



(\$6.00 Shipping)

Programmable, digital, AC or DC operation, weather button, priority, lockout button, squelch, memory backup, 2 digit LED display. Frequency coverage 29-54 MHz, 136-174 MHz, 406-512 MHz. Sizes 9"x6 1/4"x2 1/4". Includes AC adapter and telescopic antenna. Optional Cigarette Lighter Cord #142MPC \$4.99

RELM RH-256NB HIGH BAND TWO-WAY RADIO

SPECIAL PACKAGE DEAL \$339.99



(Plus \$9.00 Shipping Each)

16 channel digital readout two-way radio. Covers high band frequency range of 146-162 MHz without retuning. Perfect two-way radio for ambulance, police, fire, tow trucks, taxis, commercial companies who use this band. Features include CTCSS tones built-in, priority, 25 watts output, channel scanning, back-lighted keyboard, message light, time out timer, scan delay, external speaker jack. Size is 2 1/4"H x 6 1/2"W x 10 1/4"D.

SPECIAL PACKAGE DEAL includes RH-256NB, mobile microphone, 1/4 wave body mount antenna, mobile mounting bracket and mobile power cord, all for the low price of \$339.99.

We also have the hand-held version WHS-150 at only \$349.99.

UNIDEN BEARCAT BC-400XLT

\$99.99



(\$7.00 Shipping)

Our best selling mobile scanner, 16 channel AC-DC programmable digital. AC-DC cords, telescopic antenna, mobile mounting bracket, weather search priority, 29-54 MHz, 136-174 MHz, 406-512 MHz, external speaker and antenna jacks.

BEARCAT BC-100XLT

100 Channel Digital Programmable Hand-Held Scanner

\$159.99 (\$7.00 Shipping)



Our best price ever on a full featured complete package hand-held scanner. Manufactured by Uniden. Features include 11 bands of weather, aircraft, public service, trains, marine, plus more (29-54 MHz, 118-174 MHz, 406-512 MHz). 10 channel banks, 10 priority channels, lighted LCD display, earphone jack, channel lockout. AC/DC operation, scans 15 channels per second, track tuning. Special package deal includes the following accessories: AC adapter/charger, rechargeable Ni-Cad battery pack, flexible rubber antenna, carry case.

SPORTCAT SC-150

100 Channels - 12 Bands Including Public Service, Air And 800 Mhz

ONLY \$174.99

(\$8.00 Shipping)



Programmable hand-held sport scanner with 100 channels and 12 banks with aircraft and 800 MHz. Features include: 10 one touch direct access channels with 10 corresponding channel identifiers, band search, data lockout, headphone jack, WX search, rechargeable Ni-Cad battery, illuminated LCD, lockout, auto delay, volume and squelch control. Available in yellow and black. (Specify color.) Dimensions 2 1/4" x 1 3/4" x 6". Coverage: 29-54, 118-174, 406-512, 806-956 MHz.

Cobra SR-901

AVAILABLE ONLY FROM SCANNER WORLD ONLY!

\$74.99

Each (Plus \$6.00 Shipping Each)



\$69.99 (2 or more)

Features include: 10 programmable channels, one touch memory channels, one touch memory programming, external speaker jack, 29-54 MHz, 136-174 MHz, 400-512 MHz, squelch, lockout, full frequency digital readout, AC or DC operation, retains memory up to 3 days without power, scan button. Includes AC adapter, telescopic antenna, and complete operating instructions. Size: 7 1/4"W x 2"H x 7 1/4"D. One year factory warranty. Optional mobile cigarette lighter cord #901MPC \$4.99

UNIDEN BEARCAT BC 800XLT DIGITAL BASE SCANNER

\$229.99



(\$8.00 Shipping)

Receive police, fire, ambulance, cordless phones, marine, trains, weather, ham, stock cars, public service plus much more. frequency coverage 29-54 MHz, 118-174 MHz, 406-512 MHz, 806-912 MHz (continuous). 40 channels, AC/DC operation, digital programmable, memory backup requires 2 AA batteries (not included), telescopic antenna included, AC power cord included, external speaker jack, external antenna jack. Dimensions: 9 1/4"D x 4 1/2"H x 12 1/2"W. Channel lockout, direct channel access, scan delay, priority, digital display, auto weather button, automatic search, track tuning.

UNIDEN BEARCAT BC-760XLT

\$249.99



(\$7.00 Shipping)

Digital Programmable 100 Channel Scanner

BC760XLT covers the following frequencies: 29-54 MHz, 118-174 MHz, 406-512 MHz, 806-954 MHz (excludes cellular). Features compact size of 6-15/16"W x 1-5/8"H x 7-3/8", scan delay, priority, memory backup, channel lockout, bank scanning, key lock, AC/DC power cords, telescopic antenna, mounting bracket supplied, one year factory warranty. search, direct channel access, track tuning, service search including programmed frequencies by pushing a single button for police, fire emergency, aircraft, weather, and marine services plus exclusive optional features never available on any scanner before. First is an RF receive amplifier for boosting weak signals for only \$34.99 plus a CTCSS tone board is available for only \$59.99 to make this the number one scanner available in the USA. Optional cigarette lighter plug #760MPC \$4.99

— IF YOU CAN'T FIND WHAT YOU WANT IN THE ABOVE LISTING, GIVE US A CALL, WE MAY HAVE WHAT YOU WANT —

ORDERING INFORMATION: Call (518) 436-9606 to place orders or mail orders to Scanner World, USA®, 10 New Scotland Ave., Albany, N.Y. 12208. Orders will be shipped within 24 hours by United Parcel Service if order is accompanied by MasterCard, Visa, cashier's check, money order, COD (COD shipped by United Parcel Service will be cash or money order only). (If a COD package is refused, customer will be billed for shipping and COD charges.) Mail orders with personal or business checks enclosed will be held 4 weeks for bank clearance. Prices, specifications, and terms subject to change without prior notice. If items are out of stock we will back order and notify you of delivery date. All shipments are F.O.B. Scanner World® warehouse in Albany, N.Y. We are not responsible for typographical errors. All merchandise carries full manufacturer's warranty. Bid proposals and purchase orders accepted from government agencies only. Free full line catalog mailed 4 times per year. Merchandise delivered in New York State add your local sales tax. No returns accepted after 7 days of merchandise receipt. * Add (\$1 per item and \$4.00* for all accessories ordered at same time. COD orders will be charged an additional \$4.95 per package. Full insurance is included in shipping charges. All orders are shipped by United Parcel Service to street address only. (No P.O. Box). Shipping charges are for the 48 continental US States only. Alaska, Hawaii and all others ask for quote on shipping charge. FAX # 518-465-2945.

Scanner World, USA® • 10 New Scotland Ave., Albany, NY 12208 • 518-436-9606



The Pro 501XL, announced by Uniden, is a compact mobile rig.

ally kept in the back seat so it won't get stolen—it's a quick-disconnect type), and get help on CB. Fortunately, I got help with my second call—unlike the 10 minutes I had just wasted on amateur radio."

Klaus, you said a mouthful. It proves that mere possession of an amateur radio license doesn't make anyone the kind of person who will help out when it counts most. It's not the first time I've heard this kind of story. It makes me proud to be a CBer and saddens me a bit that some of my fellow hams aren't more helpful. Even POP'COMM's own Gordon West, an enthusiastic promoter of ham radio, says he always travels with



Instead of QSL cards, Cookie Monster sends out this novel certificate.

a CB radio because that's where he will call first if he needs help.

Some readers need your help:

Spencer G. Sholly, 709 Haynes Drive, Killeen, TX 76543, wrote to say he purchased an interesting and rare CB at a pawn shop—a portable, 40-channel, SSB

radio. It is an MRC 455 made by Mars Radio Corp., and Spence is hoping someone out there can help him with a user's manual or schematic for this rig. If you can provide the information he needs, write to him directly.

Ron, Box 1063, Orland Park, IL

PSU101 BY SSE

DESK STAND POWER SUPPLY

- Slow charge radio or operate without draining batteries.
- Dual output for radios with dual inputs.
- Connectors cables with 1.3mm and 2.8mm plugs. (supplied) choose correct plug size to fit your scanner.
- Powers radio from standard 117VAC house current.

This quality, custom designed combination desk charger and regulated power supply unit is perfect for convenient Base Station use of your handheld scanner at home or office!



**FOR: Δ AR1000XLT & 1500/8000
Δ BC200/205/25000XLT, SC150Y/B
Δ Yupitero MVT 5000, 7000, 7100**

PSU101T:
NOW for Realistic scanners, 9V Version for use with PR043, 46, 51 and other Realistic Scanners.

Electronic Distributors Corp.
325 Mill St. Vienna, VA. 22180
Phone: (703)-938-8105 • FAX: (703)-938-4525
Available at your favorite dealer.

YOU AIN'T HEARD NOTHIN' ... YET

Since 1967, CRB Research has been the world's leading publisher and supplier of unique hobby and professional books and information including:

- Scanner Frequency Guides
- Shortwave Frequency Guides
- Military/Federal Communications
- Broadcast Station Registries
- Undercover Communications
- Survival Communications
- Covert Operations
- Electronic Espionage
- Surveillance
- & Other Related Topics!

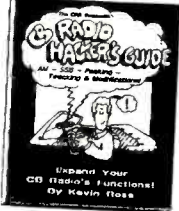

ASK FOR BIG FREE CATALOG

New titles are constantly being added to our exciting catalog. If it's interesting and unusual, we've got it. You'll see. Ask for our latest FREE catalog.

CRB RESEARCH

P.O. Box 56, Commack, NY 11725
Phone: (516) 543-9169
FAX: (516) 543-7486

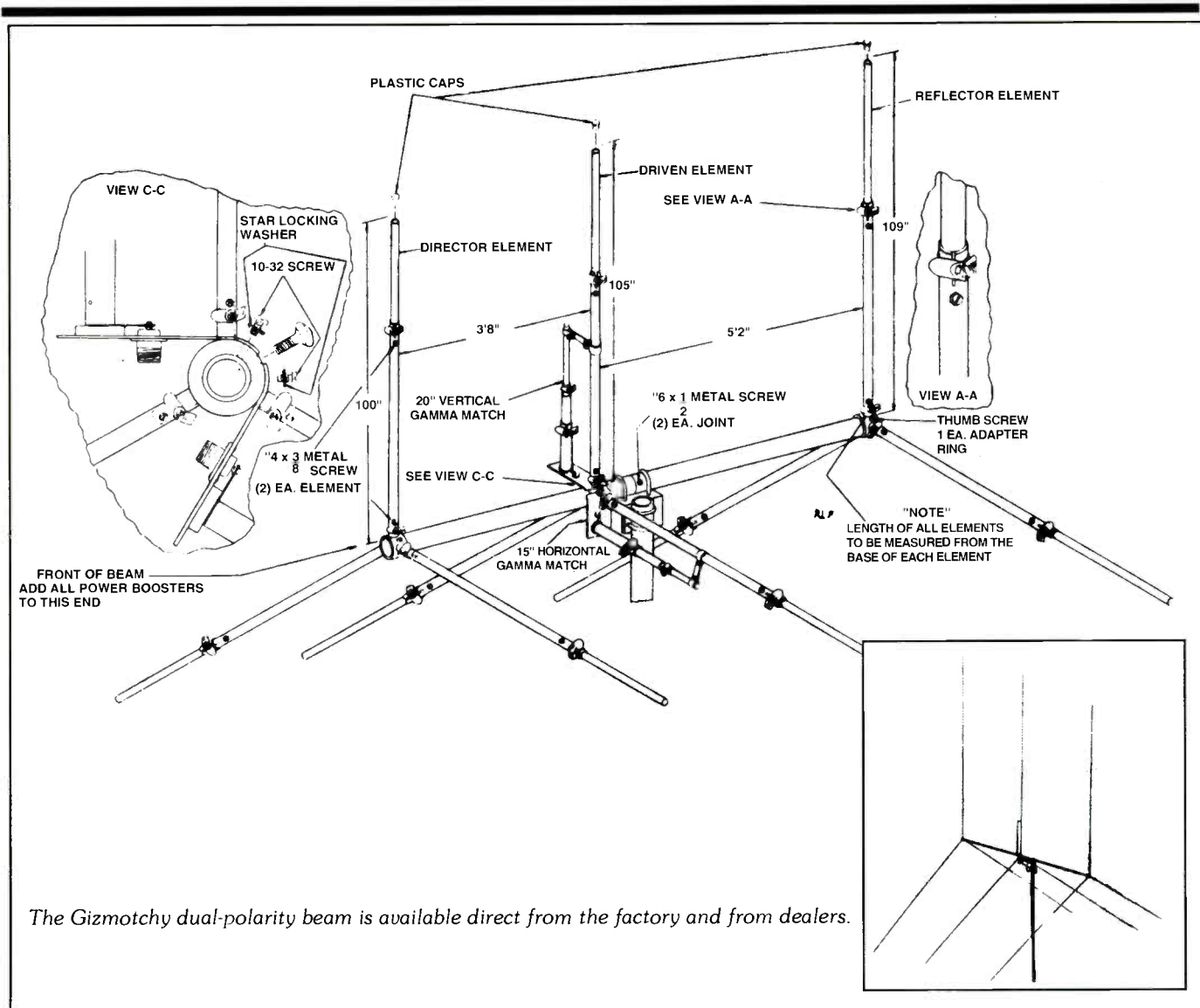

The Gizmotchy dual-polarity beam is available direct from the factory and from dealers.

60462-8063, hopes someone can help him with the address of the Alpha Tango DX Club.

B.J. Morgan from South Carolina says he has seen several CBs with the controls in the microphone, but now he is looking for one that has SSB capability. Does anybody know of one? If you do, write to me here at POP'COMM with the details.

Cookie Monster from Virginia writes in response to my asking for opinions about legal power and type-accepted radios. In addition to sending along the neat certificate he sends in place of QSL cards, here's what he had to say:

"I think the FCC set the power levels too low from the start. Most of the people I talk to want to be able to cover a 15- to 25-mile radius. Running a barefoot rig and a beam works great if you're only talking to one person. The problem comes in when you want to talk to a group, and some are south of you and some are north and so on. I think this is the reason a lot of people use omni-directional antennas and run above the legal limit.

"I think the power level should be between 50 and 100 watts. Yes, this would cause a problem because so many people subscribe to the 'higher the modulation, the better it gets out' myth, and the first thing they would do would be to cut the modulation limiter out. I think most of the bleed-over comes from overmodulation instead of higher power. Of course, so many people are doing both!

"One thing I've noticed since the ban on any amplifier that covers the 11-meter band is the quality of what people are using has gone downhill. Back when the amplifiers were made to ham radio specs, and you just modified them to use with CB, the equipment seemed to be built better. But now that it's completely illegal; the manufacturers don't worry about quality, filtering, or anything else."

You've raised some very interesting points, Cookie Monster. One thing seems crystal clear to me: an awful lot of people are running power and running it dirty—really dirty. It seems many of the offenders suffer from some sort of weird genet-

ic syndrome: they run 100 watts or more with the modulation limiter clipped, an echo mike, and a roger beep. Their radios are so badly modulated that they sound like they are talking through a kazoo, and they generate 10 channels of splatter every time they key up. It seems clear that they don't know anything about how to adjust a radio for efficient operation. If you mention the problem to them, you get an ear full of vulgarity.

On the other hand, I've heard sidebanders who I am certain are running 100 watts, and their signals are so clean that you can't even hear them just one channel away. Because running more than 4 watts on AM or 12 watts on SSB is illegal, it doesn't take Sherlock Holmes to figure out which operator is more likely to annoy fellow CBers and to attract unwanted attention that could result in a two-kilobuck fine. Thanks for an intelligent and thoughtful letter, Cookie Monster.

I look forward to your cards and letters. Please write to me here at *Popular Communications*. ■

GETTING STARTED AS A RADIO AMATEUR

Bri's Basics for Beginning DXers

Chasing DX (communicating with distant amateur stations) is a sport for the resolute amateur.

To succeed in this competitive pastime, you have to learn basic procedures. Your skill and success as a DXer will be founded on experience and careful observation of how the game is played. Spend a lot of time listening to how polite, experienced operators conduct themselves in DX "pileups" (many stations calling a single DX station at the same time). It's important to know when and how to insert your call sign when the DX operator stands by for his next QSO (conversation).

Timing is important when you chase DX. Courtesy must be foremost in your mind during these activities. Those who transmit on top of a DX station's transmission—and many unskilled hams do—deprive other operators of their acknowledgments and signal reports. Besides, a DX operator can't hear your signal if he or she is transmitting. Be courteous and call him or her after they stand by. Make sure he or she is finished with the previous QSO before you call; your turn will come if you're patient.

There will be times in your DXing pursuits when you'll feel discouraged, and don't give up. Your confidence and skill will increase as you develop good operating techniques. Learn patience; overzealousness sometimes leads to hams acting like the "bully of the frequency," with excessive power and discourtesy. Amateurs who demonstrate the greatest skill, courtesy and patience eventually are recognized by their peers for operating properly and may be nominated as a select member of the exclusive ARRL A-1 Operator Club, for which an impressive certificate is issued. (Remember last month?)

Most successful DXers equip their stations with hot antennas. Although you can win contests and earn certificates with dipoles and verticals, your chances for success increase when you install directional "gain" antennas such as yagis or cubical quads atop tall towers with powerful rotators. Full-sized verticals with quality ground-radial systems can aid your cause on 160, 75 and 40 meters. Big-time DXers (who are also, not coincidentally, sometimes contesting champions) often use stacked arrays or beams.

Equipment

When the program was created in the late 1940s, it was no small feat to qualify for membership in the elite ARRL DX Century Club (DXCC), which was awarded only

to the few amateurs who had confirmed contacts with amateur stations in at least 100 other "countries" (including Canada, Mexico, Alaska, Hawaii and Puerto Rico). Although things have changed since then—there are more hams on the air in more countries, and the technology has improved greatly, making it much easier to work hams in 100 countries—it's still a significant milestone and an exciting goal for most hams.

Do you need a fancy station with the top-of-the-line transceiver, 1.5-kilowatt power amplifier, and multiple rotatable stacked-yagi antennas to worm your way into membership in the DXCC? Determined hams have earned the right to enter the DXCC with low power and simple antennas. It can take two or three years, and considerable skill and patience to accomplish this feat. Many amateurs have worked 100 countries in two or three days, using gain antennas high in the air, during contests when international activity is high. On the other hand, many QRP low-power operators have used their 5-watt rigs to work 100, 200 and even 300 countries. To do so requires time, patience and good operating skills, but it can be done.

VHF/UHF operators work toward various levels of the League's VHF/UHF Century Club (VUCC) awards. These are presented to amateurs who submit proof of having contacted stations in the required number of grid squares (see box) on each of several bands above 50 MHz. Although many hams have done it, if you think it's a snap to work stations in 100 or more grids on 50, 144, 222 or 430 MHz, you're in for a surprise. It's a challenge and an exciting pursuit.

Many HF operators routinely put out about 100 watts because that's the maximum power output available from most of today's commercial HF transceivers. Don't just flip on your rig and leave the output-level control "wide open" all the time, though. Experiment a bit and you'll find that most of the time you'll be able to communicate fine with the RF output set only one-half or even one-fourth of the way up. A 100-watt transmitter makes things easier than if you use QRP equipment, but as you gain experience and ability, you may want to use less and less power to make contacts. This adds more of a challenge to your skill and is an excellent way to help reduce interference.

I'll assume you have a modern HF transceiver in the 100- to 150-watt power class. VHF/UHF transceivers usually put out less power, such as 10 to 50 watts. If you add

a linear power amplifier, you can gain about 10 dB of additional signal strength. To the receiving station, this is slightly less than two S units over your "barefoot" signal. Most amateurs never use or need a linear power amplifier because the extra few dB isn't noticeable under most conditions. Once in a while, one or two additional S units can spell the difference between being solid copy or being lost in the noise and interference. FCC rules and good operating practice dictate that you use the lowest power level you can to maintain clear two-way communication. Use high power *only* when it's needed.

There are many antennas you can buy or build for use at your DX station. Read the advertisements in *Popular Communications*, *QST*, *CQ* and other publications; talk to successful local DXers; and send for manufacturers' literature. If you're looking to experience the satisfaction of building your own, get a copy of *The ARRL Antenna Book*, which describes many suitable DX antennas in detail.

Your Receiving Setup

Here's the key to everything you do in amateur radio—the one thing you must master is the most important skill in amateur radio—*listening*. It's the only way to become a better operator; you don't improve by transmitting. There's an old saying in ham radio: "If you can't hear 'em, you can't work 'em." Although it sounds obvious, many new hams don't stop to

What's Your Grid?

One of the first things you'll notice in any VHF contest is that most QSOs include an exchange of grid squares. Grid squares are a shorthand means of describing your general location anywhere on earth. (For example, instead of trying to tell distant stations that, "I'm in Canton, New York," I tell them, "I'm in grid square FN24kp." It sounds strange, but FN24kp is a lot easier to locate on a map than a small town.) Grid squares are coded with a 2-letter/2-number/2-letter code (such as FN24kp). This handy designator uniquely identifies the grid square and your exact location in latitude and longitude; no two have the same identifying code. There are several ways to find out your grid square identifier. The ARRL offers a grid-square map of North America, a World Grid Locator Atlas and a program for PC-compatible computers (GRIDLOC).—Mike Owen, W9IP

think of this. Keep it in mind if you want to be a successful DXer. Not only must you be an excellent listener, you need the proper equipment. This means an antenna that can gather weak signals and a sensitive, stable receiver. Modern transceivers and receivers have a wide dynamic range (the ability to handle strong signals without overloading) and low noise figures. They have stable local oscillators and offer selectivity options that enable you to separate signals that are close together. Wide dynamic range is important if you live in an area where other amateur stations are nearby. A low noise figure helps to ensure that a receiver's internal noise won't override weak signals.

Most older equipment (1975 or earlier) doesn't measure up to modern standards for dynamic range, stability and noise figures. Although you can get by with these venerable warhorses, they can slow down your quest for hearing weak signals.

Learn how to make the best use of your receiver's noise blanker. Use it only when pulse noise, such as that from spark plugs of passing automobiles, interferes with reception. Noise blankers degrade the receiver's dynamic range and allow strong signals to overload it. Signals sound distorted and may appear broad. A noise blanker can make a DX pileup sound like a hodgepodge of garbled racket, especially if there are strong signals on or near your frequency.

Receiver Filters

Most transceivers contain stock intermediate-frequency (IF) filters in their receiver circuits. A typical stock SSB filter has a 2.4-kHz or greater bandwidth. A stock CW filter is generally designed for a 500- or 600-Hz bandwidth. The narrower the filter response, the better your chance to separate signals close in frequency, and the better your ability to copy weaker signals.

Your transceiver should have spare positions for add-on accessory IF filters. Try a 1.8-kHz SSB filter for times when the going gets rough. This filter makes voice signals sound restricted, but they can be copied. The quality of the receiver output when using a 1.8-kHz filter can be improved if you adjust the IF SHIFT control for best audio reproduction.

You might prefer a 250-Hz CW filter and a selectable 600-Hz filter. You could use the wider filter for most CW work, but when you copy a weak signal in a noisy band or when interference is a problem, try the 250-Hz filter. The narrower CW filter tends to lift weak signals above the noise threshold, which can mean the difference between solid copy or no copy at all. Adding two narrow filters isn't a frivolous expenditure for a DXer.

Shop around for a transceiver (or add-on device) that provides digital signal processing (DSP) for its filtering technology. DSP is the way to go today. A DSP filter is a remarkable device to use for tailoring

your reception for optimal response characteristics. DSP equipment used to be expensive and exotic, but now the prices of DSP processing chips, memory and other components are steadily falling, making it cheaper for manufacturers and experimenters to incorporate them into amateur radio designs. With modern digital technology, amazing results are within reach of almost every budget, and it's only going to become more commonplace. If you have a chance to try out equipment with DSP features, you'll immediately see why.

Using an Audio Filter

Audio filters are useful if you don't have narrow SSB and CW filters in your receiver. An audio filter falls short of a good IF filter, but it can greatly enhance reception of weak signals. Loud atmospheric noise, especially on 160 and 80 meters, can completely cover up DX signals. With only a 600-Hz IF filter for CW, you could call CQ on 80 meters and hear CW stations answer, but not be able to pull their call signs out of the noise. Patch an audio filter into the circuit and set it for a narrow bandwidth, and previously unreadable signals can pop right out, although the noise still might be heard plainly.

If you purchase or build an audio filter, make sure it has a variable bandwidth control and a variable-peak-frequency feature. Fixed-tuned audio filters are satisfactory for routine operating and are simple to use, but you'll do better with adjustable filters when reception is difficult.

Split-Frequency Operation

Split-frequency operation permits you to transmit on one frequency while you listen to another. The DX station may be transmitting in a part of the band where you aren't allowed to transmit, but listening for answers in your part of the band. Or the DX operator may be in your portion of the band, but listening one or more kHz above or below his operating frequency for those who answer his call. This helps manage the pileups because—if they listen—everyone calling can hear the DX station even if many stations are calling. You must use split-frequency operation in these situations.

There are many ways to operate split. Some amateurs use a separate receiver with a transceiver. They listen to the DX station with the outboard receiver and transmit with the transceiver. This arrangement permits you to monitor your operating frequency without changing the transmitter frequency. Keeping tabs on what's happening on your own frequency is helpful with respect to timing when you're trying to break through a DX pileup.

Many modern transceivers have two built-in VFOs, which is ideal for split operation. If your radio has only one VFO, you can use an outboard VFO with your trans-

**PRICE
BREAK-THROUGH**
~~\$400~~ **\$335**

NEW
Radio Shack
PRO-26
200-Channel
PORTABLE
Scanner



- Continuous coverage from 25 MHz to 1.3 GHz (except cellular telephone frequencies)
- Triple-conversion receiver virtually eliminates unwanted interference
- Hyper-Scan™ circuit scans at 50 channels/second
- NFM/WFM/AM mode-select permits tuning TV audio signals
- Automatic scan of 200 memory channels
- Weather key for instant, up-to-the-minute forecasts
- BNC antenna jack for flexible antenna (supplied) or mobile/base antenna (optional)
- Requires 4 "AA" Ni-Cd or alkaline batteries or AC or DC adaptor

Risk-FREE TRIAL 30 DAYS
Try for 30 days and if not delighted, return for a full refund. S.&H. excluded. Credit card holders call toll-free or send \$335.00 plus \$14.95 S. & H. Check or **USPS** - Money order. Allow 3 weeks for del. (Texas residents add 8.25% sales tax)

CALL 1-800-433-SAVE
FREE Since 1981 9-5 Central Mon.-Fri.

The Difference Is The Price
USRADIO®
USRadio 377 Plaza, Granbury, Tx. 76048



Talkin's No Fun Without A Jo Gunn!

4 + 4 STAR

UPS SHIPPABLE



Other Models & Sizes Available in 10 or 11 Meters

Call or send \$2.00 for Complete Catalog and Pricing of Antennas.



Route 1 - Box 32C, Hwy. 82
Ethelsville, AL 35461
(205) 658-2229
FAX: (205) 658-2259
Hours: 9 am - 5 pm (CST)
Monday - Friday

DEALER INQUIRIES, PLEASE CALL



CQ BOOK &

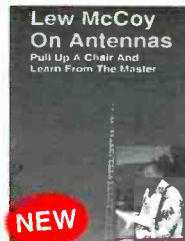

McCoy on Antennas

CQ magazine author and acclaimed authority on antenna theory and design, Lew McCoy, W1ICP, has written a truly unique antenna book that's a must for every amateur. Unlike many technical publications, Lew presents his invaluable information in a casual, non-intimidating way. **Lew McCoy on Antennas**—It's not just an antenna handbook, but a wealth of practical antenna advice for the ham! **Order No. MCCOY.....\$15.95**

NEW

Building and Using Baluns and Ununs

Written by world-renowned expert Jerry Sevick, W2FMI, this volume is the definitive source for his latest practical information and designs on transmission line transformer theory. W2FMI has unraveled the technological mysteries with designs that are simple and work. Discover new applications for dipoles, yagis, log periodics, beverages, antenna tuners, and countless other examples. **Order No. BALUN.....\$19.95**

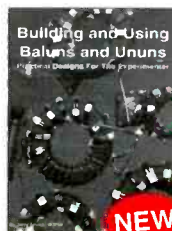

NEW

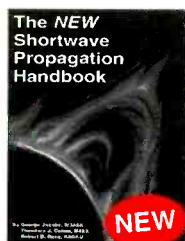

The NEW Shortwave Propagation Handbook

The most comprehensive source of information on HF propagation is available from CQ! We've built an award-winning team, gathering information from individuals and organizations around the world. Collectively, co-authors George Jacobs, W3ASK, Ted Cohen, N4XX, and Robert Rose, K6GKU, have devoted much of their professional and amateur careers to advancing ionospheric science. Propagation principles, sunspots, ionospheric predictions, photography, charts and tables galore—it's all in this unique reference volume!

NEW

Order No. SWP.....\$19.95

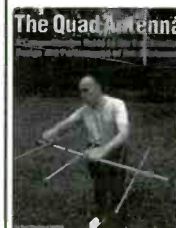

The Quad Antenna

Hams love antenna books. Written by noted author Bob Haviland, W4MB, **The Quad Antenna** is the authoritative technical book on the design, construction, characteristics and applications of quad antennas. Discover how to easily build a quad antenna for your station that will help you fill your logbook with rare DX that you've only dreamed about before.

Order No. QUAD..... \$15.95

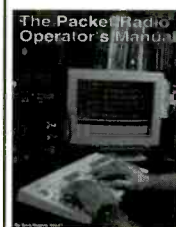

The Packet Radio Operator's Manual

This book is written by CQ columnist and Amateur Radio Packet Authority Buck Rogers, K4BT. An excellent introduction and guide to packet operation, it is the perfect single source, whether you're an advanced user or just starting out. Learn about packet radio without all the technical jargon. This book is the definitive resource for the active packet user.

Order No. PROM..... \$15.95

CQ Buyer's Guides

Dealers • Manufacturers • Product Specs • Feature Articles • Equipment Prices



1995 Beginner's Guide to Amateur Radio

Whether you're a Novice, Technician or just beginning to think about getting your license, CQ's Beginner's Guide is the perfect addition to your shack. In addition to practical articles on HF, DXing, building your first station, QSLing, and more, you'll also find our famous dealer and manufacturer's listings!

NEW

Order No. 95BBG.....\$5.95



1995 Equipment Buyer's Guide

Learn from the experts about packet radio, satellites, installing towers, SSTV, and DXing tips. Our 1995 Equipment Buyer's Guide is a package of solid information including the latest in amateur dealers and manufacturers. Discover why this year's edition is the best yet!

Order No. 95EBG....\$5.95

CQ's Buyer's Guides are the single source for information on what equipment is available, features and functions, and where to buy it!

We carry all ARRL products

Now Available Direct From CQ!

Title	Order No.	Price
ARRL Antenna Book	ARRLAB	\$30
ARRL Handbook (New Edition)	ARRLHB	\$30
ARRL Operating Manual (New Edition)	ARRLOM	\$22
ARRL Repeater Directory ('95-'96)	ARRLRD	\$7
ARRL Antenna Compendium Vol. 1	ARRANT1	\$10
ARRL Antenna Compendium Vol. 2	ARRANT2	\$12
ARRL Antenna Compendium Vol. 3	ARRANT3	\$14
ARRL Antenna Compendium Vol. 4	ARRANT4	\$20
ARRL Weather Satellite Handbook	ARSAT	\$20
ARRL FCC Rule Book	ARFCC	\$9
ARRL World Map	ARMAP	\$12

Title	Order No.	Price
ON4UN Antennas and Techniques for Low Band DXing	LOWDX	\$20
1995 NA Callbook	NACB	\$35
1995 Int'l Callbook	INTCB	\$35
1995 Callbook Pair	NAICB	\$65
Gordon West No-Code Technician Plus License Manual	GWTM	\$10
Gordon West General License Manual	GWGM	\$10
Gordon West Extra License Manual	GWEM	\$10
World Radio TV Handbook	WRTVH	\$24

VIDEO LIBRARY

Keys, Keys, Keys

Enjoy nostalgia with this visual celebration of amateur radio's favorite accessory written by CQ's Dave Ingram, K4TWJ.

Order No. KEYS.....\$9.95

The VHF "How-To" Book

This book is the perfect operating guide for the new and experienced VHF enthusiast as only Joe Lynch, N6CL, can describe.

Order No. BVHF.....\$15.95

Ham Radio Horizons: The Book

This is an excellent book for the beginner or for use in your club's licensing classes. HRH, by Peter O'Dell, WB2D, is full of information about all phases of ham radio and how to get started.

Order No. BHOR.....\$12.95

The Vertical Antenna Handbook

Take advantage of the 20 years of research and practical experience of naval communications engineer Capt. Paul H. Lee, USN(ret), N6PL. Learn basic theory, design, and practice of the vertical antenna. Discover easy construction projects such as a four-band DX vertical or a broadband array for 80 meters. Paul Lee can get you started today!

Order No. VAH..... \$9.95



All Videos Available in PAL format

Getting Started in Ham Radio

This is a fast-paced video introduction to the fascinating world of ham radio. CQ's experts show how to select equipment and antennas; which bands to use; how to use repeater stations for improved VHF coverage; the importance of grounding and the basics of soldering. Get the most out of your station, whether it's home-based, mobile or hand-held.

Order No. VHR\$19.95

Getting Started in Packet Radio

This video will help de-mystify the exciting but sometimes confusing world of packet radio. Learn how to get started using your computer on the radio. Included are step-by-step instructions on making packet contacts and using packet bulletin boards, networks and satellites.

Order No. VPAC.. \$19.95

Getting Started in Contesting

For the newcomer to contesting or an experienced veteran, this video is for you! You'll get advice and operating tips from some of contesting's most successful competitors, including Ken Wolff, K1EA, Dick Newell, AK1A, and CQ's own contest columnist, John Dorr, K1AR. Here's just a sample of what you'll see: what contesting's all about, explaining contest jargon, tips for beginners, how to compete from a small station, operating secrets from the "pros", live QSOs from world-class stations, and VHF/UHF contesting.

Order No. VCON\$19.95

Getting Started in Amateur Satellites

Learn with this video how veteran operators set up their satellite stations. Find out how to locate and track ham satellites with ease. Watch as operators access current satellites and contact far ranging countries around the world. This video is filled with easy to understand advice and tips that can't be found anywhere else.

Order No. VSAT..... \$19.95

Getting Started in DXing

Top DXers share their experience with equipment, antennas, operating skills, and QSLing. You'll see hams work rare DX around the world. If you're new to DXing, this video is for you! All this valuable information may well give you the competitive edge you need to master the world of DXing.

Order No. VDX..... \$19.95

Getting Started in VHF

This is the ideal introduction to VHF. See demonstrations of the latest radios. Also, learn about repeater usage as well as the more exotic VHF operating modes. Whether you are interested in packet radio, satellite operation, or simply using your local repeater, this is your video!

Order No. VVHF.....\$19.95

Ham Radio Horizons: The Video

This introduction to Amateur Radio is an excellent complement to the Ham Radio Horizons book. Enjoy seeing all aspects of ham radio ranging from what it takes (and costs) to get started to how you can get your ham license. HRH is ideal for public events, presentations to community groups and as an opening to your club's licensing courses!

Order No. VHOR.....\$19.95

Order Toll-Free 1-800-853-9797

YES! I want to learn from the experts. Rush me my book(s), video(s), buyer's guide(s) right away!

Please add \$4 shipping & handling. **FREE** shipping & handling for orders \$50 and over.

Please make your check or money order payable to: CQ Communications, Inc.

Qty	Item #	Description	Price	Total Price
Shipping/Handling				
NY State Residents add applicable sales tax.			Total	

Name _____ Callsign _____

Address _____

City _____ State _____ Zip _____

MC/VISA/AMEX/Discover # _____ Expires _____

Form of payment: MC VISA AMEX Discover Check Money Order

Please mail your orders to: **CQ Communications, Inc., 76 North Broadway, Hicksville, New York 11801-9962** FAX 516-681-2926

WORLDS SMALLEST FM TRANSMITTERS

MICRO-MINIATURE FM TRANSMITTER!

In spite of its micro-miniature size, the XWB1000-EZ transmitter kit punches out a signal up to 1/2 mile away! Including the battery, this is absolutely the smallest FM transmitter available. Miniature battery and holder included on circuit board for minimum size. Amazing audio sensitivity. Picks up sounds at the level of a whisper. Use with any FM broadcast receiver from 88 to 108 MHz. XANDI's famous E-Z kit approach makes assembly a snap. Kit includes pre-assembled surface mount module, microphone, antenna wire, and battery.

● **XWB1000 E-Z \$49.95**

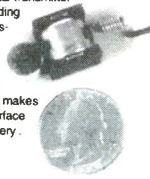

LONG RANGE CRYSTAL CONTROLLED FM TRANSMITTER!

With a range of up to 1/2 mile, the new XTL1000-EZ transmitter KIT is an outstanding performer. Miniature battery and holder included on circuit board. Amazing audio sensitivity. Picks up sounds at the level of a whisper. Works with any VHF scanner or surveillance receiver at 143 MHz. XANDI's famous E-Z kit approach makes assembly a snap. Kit includes pre-assembled and tested surface mount module, microphone, antenna wire, and battery.

● **XTL1000 E-Z \$69.95**

LONGER RANGE CRYSTAL CONTROLLED FM TRANSMITTER!

With a range of up to 1 mile, the new XTL3000-EZ transmitter E-Z KIT outperforms any other unit available. Miniature battery and holder included on circuit board. Amazing audio sensitivity. Picks up sounds at the level of a whisper. Works with any VHF scanner or surveillance receiver at 143 MHz. XANDI's famous E-Z kit approach makes assembly a snap. Kit includes pre-assembled and tested surface mount module, microphone, antenna wire, and battery.

● **XTL3000 E-Z \$89.95**



1-800-336-7389

SATISFACTION GUARANTEED.

CHECK, VISA, MC, MO
or COD, S&H EXTRA

ASK FOR OUR
NEW CATALOG!



XANDI Serving The Public Since 1961
ELECTRONICS, INC.
1270 E. BROADWAY RD #113, TEMPE, AZ 85282

CIRCLE 86 ON READER SERVICE CARD

Privacy • Communications • Hobbyist

Experienced & Specialists In: Countermeasures

- Scanners • Frequency Counters • Night Scopes
- Confidential Frequencies • Codes • Binoculars •
- Spy Scopes • Reports & Journals On Locating
- And Removing Electronic Evesdropping Devices •
- C.B.'s & Accessories • And Much More!

We Guarantee Top Quality! Catalog \$5.00
(deductible with 1st order)

We Also Do "Sweeps" For Local Residents.

Precision Electronics

7841 Reseda Blvd., Suite 223

Reseda, CA 91335

(818) 344-5863

FAX (800) 555-7446 24 hr orderline

CIRCLE 70 ON READER SERVICE CARD

VIDEO SYNC GENERATOR



**Restores Horizontal
and Vertical
Sync Lines from Distorted
Analogue Video Formats**

For Free Information Package on Completed Units and Pricing



• Call 219-236-5776 •



R.C. Distributing • PO Box 552 • South Bend, IN 46624

CIRCLE 7 ON READER SERVICE CARD

ceiver to permit split operation. If the frequency difference between transmit and receive is less than 2 or 3 kHz, you can use your RIT or XIT controls to cover the small frequency split.

You'll seldom succeed by calling a DX station exactly on its frequency. Many calling stations do that and the resulting bedlam of interference on the DX operator's frequency makes it difficult for him to sift a single call sign from the tangle. Try calling him 1 or 2 kHz above or below his frequency. The interference is lower when you slide away from his frequency a bit, and he'll probably find you by using his RIT control. Hams in "rare" countries or on DX-peditions usually listen at the fringes of the pileup—perhaps 1 or 2 kHz above their transmit frequency.

Snagging the DX Station

Most DX stations operate in the amateur extra class parts of the U.S. amateur bands. On CW, you'll usually find them at 3500-3515 kHz, 7000-7025 kHz and 14000-14025 kHz. This should provide an incentive for you to upgrade your license class someday, but there's plenty of action for you with any license class. Many DX stations use the novice and general class subbands. You also can work them in the bands that don't have amateur extra class segments, such as 10, 12, 17 and 30 meters. But the most intense DX operating always seems to occur at the low end of each CW and phone band.

Suppose you wish to communicate with a European station. How should you proceed? First, choose a part of the day when the band is usually open to that part of the world. Next, spend time tuning and listening. This will give you a grasp on band conditions and the level of DX activity at that time of day. Once you establish that the band is suitable for DX QSOs, you might call CQ or answer the CQ of a DX station. A general CQ probably will net you a state-side reply because U.S. amateurs will assume that you're simply looking for someone with whom to chat. You'll do better by sending a directional CQ, if DX is your sole objective. In this situation, you can CQ as follows: CQ CQ CQ EU DE WS10 K

The EU signifies that you prefer to have a QSO with someone in Europe. Although it's acceptable to transmit CQ DX CQ DX CQ DX DE WS10 K, some hams object to this procedure and feel that a directional CQ is more appropriate because a general CQ DX may yield a QSO from any corner of the world. Calling CQ DX makes it clear that you don't want to talk to hams within the borders of your country.

Maybe you want to talk to someone in a particular country. Try using a directional CQ. If you want to talk to someone in Spain, your CQ can be structured as follows: CQ EA CQ EA CQ EA DE WS10 KN. The EA is for the Spanish prefix and the Morse code KN (sent as one character,

DADIDADADIT) indicates that you prefer to have only an EA station respond. Most amateurs use KN during ragchews with friends. This tells other hams that you don't want to get into a multistation QSO while you're chatting with a friend.

Answering a DX CQ

Things can be complicated if, as a newcomer, you answer the CQ of a DX station. It's worse if the operator is in a rare country (such as small country with few hams). Rare countries are in such demand that a pileup of stations is sure to begin when the operator from that land calls CQ. Not only will you hear U.S. stations calling him, but hams from all over the world will become part of the pileup. A timid operator may be afraid to get involved in the resulting bedlam!

QRZ means, "Who's calling me?" A DX station operator may be unable to copy a single call sign the first time he or she stands by because of intense interference, or he or she may get part of a call sign suffix. If so, he or she may come back with "QRZ AW?" with AW the suffix of, for example, W1AW. At this point, all other callers should stand by for the station or stations with the AW suffix and allow the contact to take place.

The DX operator may not only be unable to extract a call sign from the pileup, but may not get a suffix or a part of one. In this case, he or she will wait until the roar from all the calling stations subsides, then call CQ or QRZ again. Eventually he or she will recognize one caller and initiate a QSO. The loudest, cleanest signals are the ones acknowledged first. Be patient; eventually you'll be heard, as the layers of louder signals diminish. It may take 15 or 20 minutes to be heard by the DX station, but don't give up.

This is a good example of when to call the DX station above or below his or her frequency, as discussed in the previous section. Use your RIT or XIT control to place your signal at the edge of the pileup.

Avoid long replies to the CQ of a DX station. Not only is this type of conduct apt to brand you as a "lid," but it's not effective for obtaining a reply from the DX operator. It's better to be terse when calling and if you aren't recognized the first time around, wait and try again.

You may want to adopt the "tail-ending" technique when calling a DX station. It consists of simply giving your call sign once, such as DE WS10, just after the DX station completes a QSO with another station, but before it calls CQ or QRZ again. A skillful tail-ender makes sure that the DX operator has finished his or her transmission before dropping in a call sign. Don't include the call sign of the DX station; this saves time and minimizes the pileup magnitude. The only time you must give the other station's call sign is at the end of an exchange of third-party traffic with a for-

eign country. Careful, considerate tail-ending is an acceptable practice.

Avoid being "windy" when you contact a DX station that has others waiting to work it. Stick to the basics of the QSO, such as your name, QTH, his or her signal report and perhaps QSL information. Sign off quickly and allow the next person to work the station. If the DX operator wants to ragchew with you, and if no one else is waiting, you can go ahead and discuss other topics. Some DX operators never ragchew, while others prefer to chat for a while. You'll recognize which type of person the DX operator is by paying attention to the operating style and the nature of his or her conversations. Follow the DX ham's lead.

Tail-ending takes skill and timing to be successful. Some hams wait until the pileup subsides somewhat before they drop in their call signs. This ensures that they have less competition and the chances are that their signals will stand out better than if they were to give their call signs at the start of a pileup. This procedure isn't as necessary if you reply to the DX station a couple of kHz off his or her frequency, where the number of signals is smaller. You can break large pileups with a 2- or 5-watt CW rig. Good timing and calling off frequency makes it possible. It's seldom a matter of who has the most power and largest antenna when it comes to getting the attention of the DX station. No amount of hardware can make up for a lack of operating proficiency, and the most skilled operators can make a contact under seemingly impossible conditions. Consider skill the most important component in your amateur operation. Excellent operating techniques separate the world's greatest ham operators from the lids and the amateurs "with expensive toys."

The DX Ragchew

If you have the good fortune of finding a DX station operator willing to chew the rag, cherish it! Don't be disappointed if the person is unable to talk for a long period. They may have limited knowledge of your language and may not understand all that you say. In this situation, speak slowly and clearly. Slang expressions and regional sayings (such as, "I bent over backward for her") may be misunderstood by those who live in other countries. You'll discourage a foreign ham if you don't stick to clear, simple English. Avoid speaking rapidly on SSB. A foreign ham with a limited grasp of English will have difficulty understanding a fast talker. It's like trying to copy CW at speeds beyond your capability. Don't send CW at a speed faster than that being sent by the DX operator. (This is a good rule, no matter who you're communicating with; it's a courtesy all hams should extend.)

If ragchewing with DX operators is something you enjoy, plan your contacts appropriately. It's more likely that you'll find smaller pileups and less competition

The Best* Just Got Better!

The Eavesdroppers™ now includes our new Zap Trapper™ Electronic Gas Tube Lightning Arrestors. Receive-only design shunts damaging transients to ground at only 1/7th the voltage buildup of the available 200 watt transmit-type arrestors, providing maximum solid state receiver protection.

Protect your investment - combine an excellent shortwave receiving antenna with the best receiver protection money can buy.



- Completely assembled and ready to use
- Only 42' overall length
- 8 trap circuits permit reception on all shortwave bands, 11-90 meters.
- All connections soldered and enclosed in ultrasonically-welded, hermetically-sealed trap covers
- Includes 50' of 450 lb. test nylon rope

- Model T includes 100' twinlead feedline
- Model C includes weatherproofed center connector for your coax & coax sealant
- Either model \$79.95
- UPS for lower 48 states \$5.00
- COD add \$4.50, IL add 7% sales tax
- Foreign shipping quoted

*"The best...built like an antenna should be."—Larry Magne in *World Radio TV Handbook*

*"Our best seller."—EEB in their recent ads and catalogs

*"Now in use in 45 countries."—Giffler Shortwave in 1983

Antenna Supermarket

P.O. Box 563 Palatine, IL 60078 Tel (708) 359-7092 Fax (708) 359-8161

At your dealer or direct • Visa & Mastercard accepted

**Complete Your Collection of
Popular Communications
Order Your Back Issues Today!**

**\$3.50
Per Issue**

for a DX operator's attention if you come across him or her on a weekday morning, after most U.S. hams have gone to work or school, calling CQ or answering your CQ DX call. Many DX operators prefer ragchewing to running strings of quick contacts because they cringe at the prospect of being deluged under a pileup—and the subsequent blizzard of requests for QSL cards—whenever they fire up their radios. If you can tell that DX ham wants to have a nice chat, settle down and enjoy the pleasure of getting to know them, their country and their interests. This is your chance to spread international goodwill and experience a foreign culture and perspective from the comfort of your shack. Many warm, enduring friendships have formed between hams in different countries who meet on the amateur bands.

Avoid Certain Topics

There are extreme differences in religion, politics and culture around the world. It's easy to offend others if you force your philosophies on them. If you broach cer-

tain delicate topics, you may inspire the DX contact to sign off. Suggestive remarks and vulgarity are out of place in amateur radio and this type of talk may be especially offensive to a ham from another land.

There are many acceptable things to discuss during a DX QSO. Most hobbies have universal appeal. You can begin a satisfying conversation by talking about your line of work, your families and amateur radio in general.

One last hint: Don't inflate the signal report you give to the DX operator. He's more interested in knowing how well his station is doing abroad than in being flattered with "59" if you can barely hear him. Fudged signal reports won't hasten or ensure the receipt of a QSL card.

As mentioned in August, next month the timing will be about right for an introduction to contest operating as we move into the busy fall contest season. Meanwhile, get on the air and start racking up countries, have fun and send your mail to me at ARRL HQ, Dept PC, 225 Main St., Newington, CT 06111; or e-mail: bbattles@arrl.org. ■

SATELLITE VIEW

BY DONALD E. DICKERSON, N9CUE

INSIDE THE WORLD OF SATELLITE COMMUNICATIONS

Phase Three

Phase Three is a term amateur radio operators use to describe their next major space project—the launch of the largest, most complex, and expensive amateur radio satellite to date. It will make worldwide communications by satellite one step closer for amateurs once it is in orbit. The world's first amateur spacecraft was launched by the U.S. in 1961, only four years after Sputnik.

The first satellite was called a Phase 1 spacecraft. This means the satellite carried simple radio beacons in a low orbit, and had a very short life expectancy. The next generation of amateur satellites to be launched were in a higher orbit, but still considered a Low Earth Orbit (LEO). They had a longer life expectancy and

carried transponders that used the popular 29, 145, and 432 MHz bands. These were Phase II spacecraft.

In 1980, the amateur radio community began launching Phase 3 satellites. These larger, heavier, and higher satellites carry complex transponders into the microwave frequency range. Phase 3 spacecraft were launched into a unique Russian orbit, a highly elliptical Molniya orbit named after the spacecraft that first used it. This unusual orbit allows the spacecraft to remain over the horizon for the direct line-of-sight communication required by the satellites. Two such spacecraft were launched during the 1980s. The first was launched on an Ariane launch vehicle provided by the European

Space Agency. It was, unfortunately, one of the few Ariane launch vehicles to fail, leaving the satellite called Oscar 10 at the bottom of the sea.

As with previous Phase 3 satellites, an international team of volunteers now is laboring diligently to complete construction of the current Phase 3-D spacecraft. The European Space Agency will launch it on its new heavy lift vehicle, the Ariane 5. The launch is tentatively set for next spring.

Phase 3D is unique in design and is the first of its kind to allow a combination of uplink frequency bands to be relayed and downlinked on one or more combinations of bands. It will receive on the 145, 436, 1270, and 5600 MHz bands, and

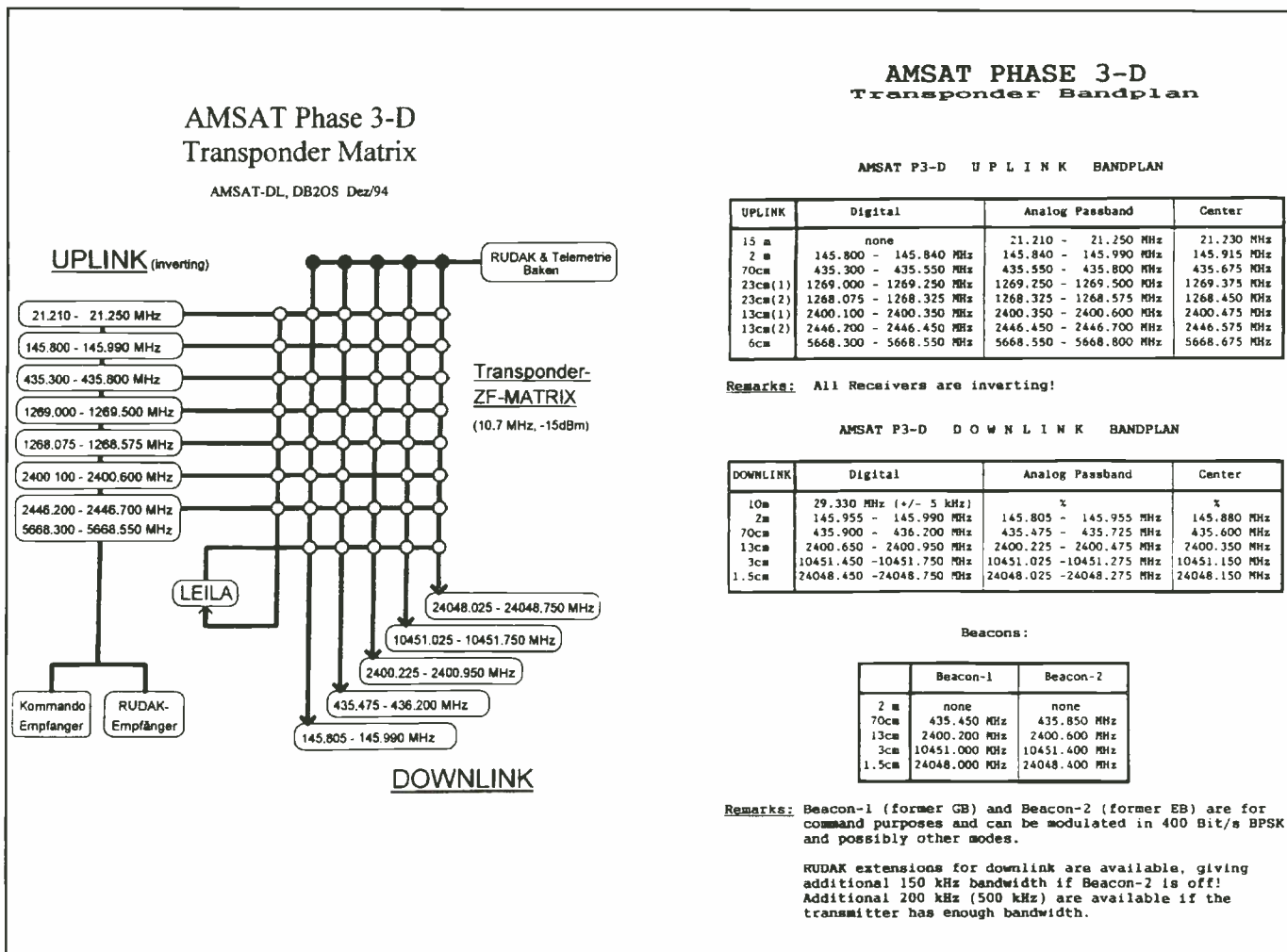

Courtesy of AMSAT-UK.

AMSAT is a worldwide, non-profit, educational organization that promotes space research and communication by building, launching, and controlling non-commercial amateur radio spacecraft.

AMSAT teams from around the world, many of them working on their own time and in their own homes, now are building the next major amateur radio satellite. Called Phase 3D, it will be the largest, most complex, and most expensive amateur radio satellite ever built.

For more information, contact AMSAT-North America, Keith C. Baker, KB1SF, 1324 Fairgrounds Road, Xenia, OH 45385-9514. Phone/FAX: (513) 429-5325.; CompuServe: 75070,331; Internet: "KB1SF@AMSAT.ORG"

transmit on the 29, 145, 2400, 10500, and 24000 MHz bands.

How do amateur radio operators obtain and launch spacecraft? They volunteer to help design and construct the equipment they will need and test it to ensure it is spaceworthy before launch.

In efforts to coordinate this task, a non-profit organization was established to help raise funds for such projects. Hence, the initiation of the Radio Amateur Satellite Corp. of North America. Each country participating in project Phase 3D has AMSAT organizations in their respective countries.

At last year's AMSAT-UK colloquium in England, Ron Broadbent, M.B.E. and honorary secretary of AMSAT-UK, announced that the new Phase 3D satellite will carry a 145 and 436 MHz combination that is expected to be the most popular combination. A member of AMSAT-UK, Mike Dorsett, G6GEJ, will be designing and building part of this system; and many other amateur radio operators in the U.S., Britain, Germany, Japan, and South Africa are contributing to this international project.

Dick Jansson, WD4FAB, AMSAT-NA vice president for engineering, states: "Each country's team is performing their assigned tasks very well." He further mentioned that Mr. Dorsett is right on schedule with his design.

The satellite will weigh more than 800 pounds, will measure 7.5 feet in diameter, will be three feet in height, and its solar panels will extend to more than 20 feet at launch time. Phase 3D's elliptical orbit will bring it within 2,400 miles of the earth's surface at its lowest point, and extend to more than 29,000 miles at its highest height. The satellite will be three-axis stabilized, which means its antennas

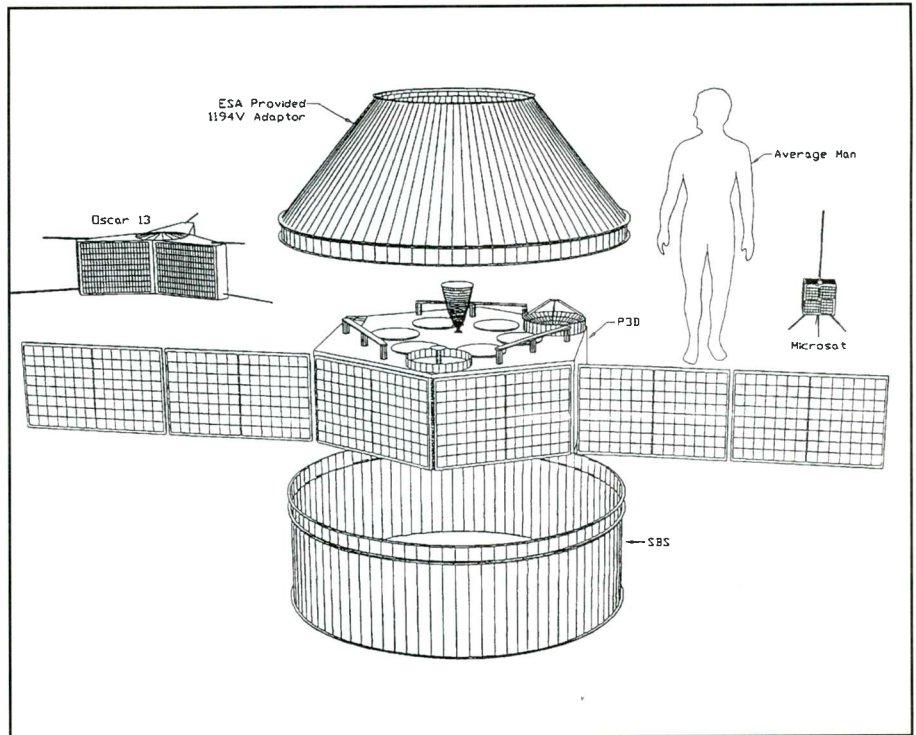

remain pointed toward earth—a relatively new and costly feature for amateur satellites. The three high-gain antennas will have an ERP of 10 to 20 kilowatts.

The spacecraft also will carry GPS receivers that will allow ground controllers to keep abreast of the satellite's location at all times. Three digital cameras tied to the 2400 MHz downlink also will be included; two will be pointed toward the earth, while

the third will be combined with a telescope and turned toward the stars.

AMSAT-NA President Bill Tynan, W3XO, said, "We're still on schedule for the 1996 launch. I am really proud of the way everyone on the North American team is pulling together to ensure our responsibilities to the international project are met." We hope this next project is a success. See you next month. ■

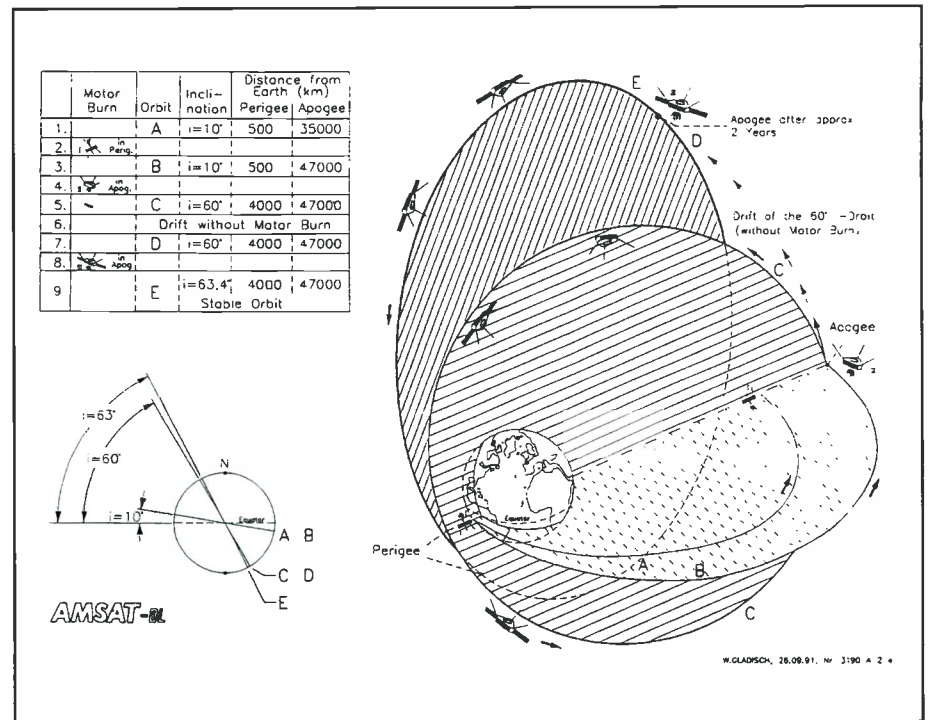

WHAT'S HAPPENING: INTERNATIONAL SHORTWAVE BROADCASTING BANDS

It's not often that small stations make big shortwave broadcast news. Tiny Mexican broadcaster Radio Huayacocotla (2390 kHz) has been closed down by the Mexican government. The station, which uses the slogan "voice of the campesino," was subjected to a technical inspection by engineers from the Secretariat for Communications and Transport who reportedly found several technical violations.

The SCT inspectors carried written authorization allowing them to close the station if any technical inadequacies were found, which they then did, citing these faults as a danger to station operators. Mexican broadcasters normally have 60 days to correct violations before such action is considered. (The violations included the antenna tower being improperly painted, an extra restraining cable, no spare back-up transmitter, etc.)

Apparently, over a period of several months prior to the shutdown, the station had received numerous calls from various government agencies seeking information about the facility and the people employed there. The station earlier had been accused of transmitting coded messages and inciting violence.

Many who do not favor the Mexican government see this incident as an attempt by the government to silence a voice that not only favors the campesinos but actively supports them.

More Adventures

Apparently the "Voice" has plans to put up one or more new antennas at the Greenville site. It seems that the Greenville facility, which now transmits the Radio Marti service, can't cover Cuba effectively. The Bethany facility—which the Voice of America has closed down now and dismantled—used to be the Radio Marti site and was perfect for the job. The VOA Sao Tome shortwave relay isn't expected to be active until late this year.

Radio New York International likely will be back on the air by the time you read this, although as a program instead of a station operating its own transmitter. In a news release, RNI head Alan Weiner says RNI will air on Sunday nights at midnight to 1 am ET (0500-0600 UTC) on 7435, over the transmitter of WWCR, Nashville. Weiner says the RNI program will "tell the other side of the story" (as opposed to the many right-wing programs on shortwave) and "try to inspire people to be tolerant and compassionate and loving."

Radio Vlaanderen International in Belgium now also is heard via one of Deutsche Welle's transmitters at Juelich. It's in use



Marty Foss, Alaska, sends this photo of the NHK building in Sapporo, Japan.

Mondays through Saturdays at 0830-0855 on 7105 in German.

Voice of Russia

There's more downsizing going on at the former Radio Moscow. Broadcasts in Indonesian, Khmer, Nepalese, Sikhalese, Swahili, Hausa, Tamil and Swedish have been discontinued. Six hours of French language broadcasts have been sliced. Spanish has been cut by four hours, Portuguese

by three and a half, and another dozen or so languages also were cut back. The total number of languages the Voice of Russia broadcasts now is 30, compared to 46 a year ago. Broadcasting hours have been cut nearly in half since last summer—down to about 546 hours per week. On the other hand, a separate service for western North America has restarted, currently scheduled at 0600-0700 on 12040.

United Nations Tests—UN Radio in Geneva, Switzerland, is conducting test broad-

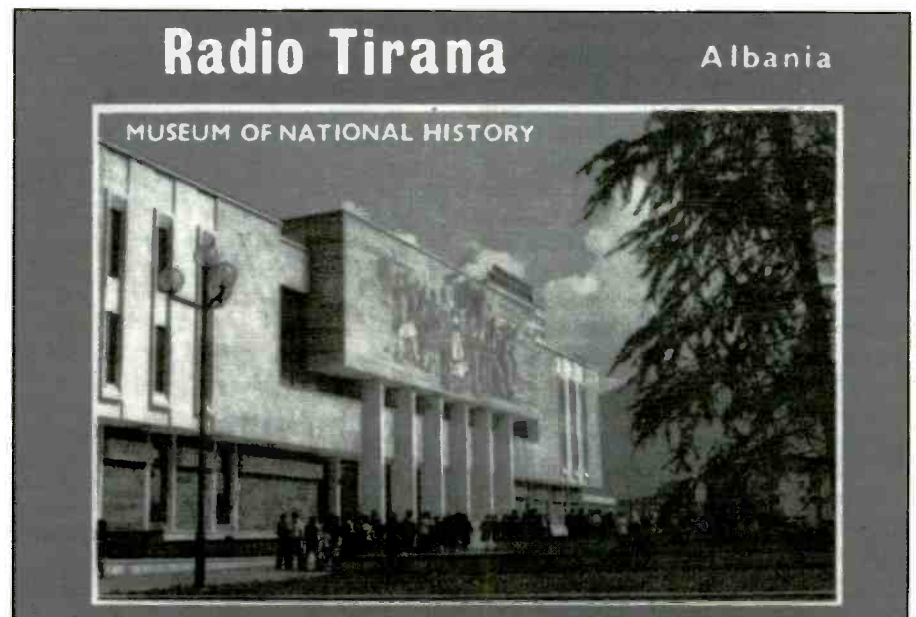

The facilities of Radio Tirana Albania now carry the programming of religious broadcaster Trans World Radio.



Stan Schmitt received this colorful QSL card from Radio Vilnius, Lithuania. It's in blue, black, yellow, green, red and white.

casts, and apparently has been for several months. They're scheduled at 0600 and 1800 on 10461 (probably in sideband mode) and on 17520 at 1200. Reports go to United Nations Radio, Plais de Nations, Bureau, 1211 Geneva 10, Switzerland.

Brazil—Check the Radio Bandeirantes frequency of 11925. It's supposed to be carrying test programming from a station new to shortwave—Radio Juratel. No times have been indicated.

TWR via Albania—Two of Radio Tirana's 100-kW shortwave transmitters now are being used by religious broadcaster Trans World Radio for broadcasts to Central Europe. Check 11635 at 0500-0515 for Kurdish, then Polish on 7385 and 9470 from 0515-0530. There's also a Russian broadcast at 1730-1815 (Sundays to 1830) on 94590 and 11635.

Another former communist nation now carrying western voices is Lithuania. Its Sitkuani shortwave site now broadcasts programs of Radio Free Europe/Radio Liberty. The broadcast—in Lithuanian—currently airs at 1800-1900 on 9710.

Ecuadorian shortwavers may be running shorter schedules these days because of a government proclamation rationing the use of electricity. The southern part of Ecuador has experienced abnormally light rainfall that has impacted the amount of power produced by a large hydro-electric power station in that part of the country.

Radio Japan from the South Atlantic

Radio Japan has another new relay point—Ascension Island. The BBC facility there is in use on 17815 at 0700-0800 in English, 0800-0900 in Japanese on 15135 and 17815; from 1300-1400 in

Japanese on 15400 and 21490, and 1530-1600 in French on 15120 and 17880.

Your input is always sought and always most appreciated. Logging submissions should be by country, with cutting room left between each. Your last name and state abbreviation should appear after each item.

Shack and shortwave station photos, spare QSL cards, schedules and other station literature, general station, and shortwave broadcast-related news are needed. We're also glad to highlight local and regional shortwave clubs looking to expand their memberships.

Here are this month's logs. All times are in UTC, which is five hours ahead of EST (0000 UTC=7p.m. EST). Language broadcast is assumed to be English (EE) unless otherwise indicated (SS=Spanish, FF=French, AA=Arabic, etc.)

ALASKA—KNLS, 7365 at 1337 in EE/CC with music. CC at 1401. (Pappas, SD) KNLS says it accepts faxed and taped reports. Reports must include the date and time (UTC only), frequency (approximate is acceptable) and as many program details as possible. Only one QSL will be sent for each report no matter how many you send. Special seasonal QSLs are awarded to the first 200 reporters in each broadcast season. KNLS says it does not QSL for "other transmitter operators who carry World Christian Broadcasting programming." The address is P.O. Box 473, Anchor Point, AL, 99556.

ANTIGUA—BBC relay, 6195 at 1130. (Williams, TX)

Deutsche Welle relay, 15275 in GG at 1248. (Wms, TX)

ARGENTINA—RAE on 15345 at 0017. (Vaage, CA) (SS or EE?)

ASCENSION ISLAND—BBC relay, 6005 at 0303 and 9600 at 0332. (Wms, TX)

AUSTRALIA—VL8A, Alice Springs, 2310 at 1051 with rock and light music, talk. Poor. (Pappas, SD)

Radio Australia, 5995 (Shepparton) at 1345. Also Darwin, 9510 at 1421 in CC. (Wms, TX) 5995 at 1201; 6020//6080//9710 at 1144 in Tok Pisin (Pidgin English, ed.) with pops, ID, mention of Papua

Make the
"COPPER Connection"...

EAGLE 2000 BASE \$419.99

EAGLE 5000 BASE \$599.99

EMPEROR TS-5010 \$219.99

COBRA 148GTL \$149.99

UNIDEN PRO 510XL \$34.99

RANGER RCI 2950 \$239.99

PDC 66 \$69.99

SOLARCON A99 \$49.99

WILSON 1000 MAG MT... \$59.99

K40 ANTENNA \$39.99

NIGHT STICK 7' \$14.99

TUNEABLE / 10K

(other sizes also available)

UNIDEN BCT2 \$99.99

UNIDEN BCT7 \$159.99

UNIDEN BC350A \$99.99

SPORTSCAT (yellow or Black) \$159.99

UNIDEN BC560 \$79.99

Call for Dealer Pricing!

"Scan" Our Catalog for
the Complete Line
of Scanners!

CALL TOLL-FREE

1-800-626-6343

Free "Full-Line" Catalog ~

CB's, Accessories, Antennas, etc.

COPPER ELECTRONICS, INC.

3315 GILMORE INDUSTRIAL BLVD.

LOUISVILLE, KY 40213

502-968-8500

FAX: 502-968-0449

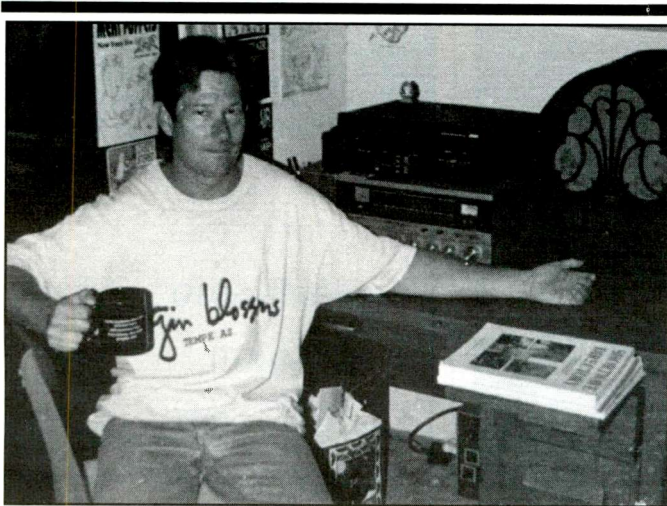

Rick Barton in his Phoenix, Arizona, shack, to which he later added more equipment.

New Guinea. IS and off at 1158. (Lamb, NY) 9580 at 0709 with news of Pacific. Also 9860 at 0708. (Wilden, IN) 9615 at 1519 with "Asia Focus." (Pappas, SD) 11800 at 1353. (Jeffery, NY)

11900 at 0640. (Snyder, OK) 17860//17795. (Vaage, CA)

AUSTRIA—Radio Austria Int'l, 6015 (via Canada) at 0633, ID and address at 0655 and off 0700. (Wilden, IN) 0655. (Snyder, OK)

BOLIVIA—Radio Pio Doce, 5946 at 1101 in SS with ballads. (Wms, TX)

BRAZIL—Swiss Radio Int'l relay, 5887 at 0256 in SS and s/off. (Wms, TX)

Radio Marajoara, Belem, 4955 at 0324 in PP. (Wms, TX)

Radio Educacao Rural, 4755 at 1111 in PP. (Wms, TX)

Radio Nacional Amazonia, 6180 at 1145 in PP. (Wms, TX)

Radio Nacional, 15445 at 1258 EE to NA/CA, program about Carmen Miranda. (Wms, TX)

China Radio Int'l relay, 17755 at 0131 in EE/SS. (Vaage, CA)

Radio Aparecida, presumed, 5035 in PP at 0114 with Christian music, religious talk, possible address. (Lamb, NY)

Radio Alvorada, 4965 at 0135 in PP with talks, old Brazilian pops, off at 0200. (Lamb, NY)

Radio Brazil Central, 4985 at 0118 in PP with Brazil pops, jingles, presumed news. (Lamb, NY)

Radio Anhanguera, 6080//11830 at 0036 in PP, news, canned IDs, promos, jingles. (Lamb, NY)

Radiobras, 15350 at 1220 with ID. (Northrup, MO)

Radio Bandeirantes, 9645 at 0022 in PP with music and ID. (Jeffery, NY)

Radio Nova Visao, 11705v, 2230 in PP with religious program, ID at 2300. (Rausch, NJ)

BULGARIA—Radio Bulgaria, 5890 in Bulgarian at 0340. (Wms, TX) 9700 with news at 0400. (Gillihan, AR)

BURUNDI—Rdf Burundi, 6140v in FF at 0301 sign on with choral national anthem, ID, light pops, FF/EE. ID "Ici Bujumbura" at 0330 and YL with mention of Rwanda. (Rausch, NJ)

CANADA—Radio Canada Int'l, 6000 in FF at 0348; 13670 at 0255 in unidentified language and 15260 at 1700. (Wms, TX) 6150 at 0610. (Wilden, IN) 9755 at 0230. (Gillihan, AR) 13690 at 2209. (Jeffery, NY)

BBC relay 5960 at 0344. (Wms, TX)

Radio Japan relay, 5960 at 0344. (Wms, TX)

Radio Korea Int'l relay in KK at 1120 on 6145. (Wms, TX)

Deutsche Welle relay, 6085 at 0307. (Wms, TX)

CHNX, Halifax, 6130 reactivated with relay of CHNS oldies format at 1715. Currently using only 28 watts! (Rausch, NJ)

CFRX Toronto, relay CFRB, 6070 at 1946. (Wilden, IN)

CHILE—Radio Esperanza, 6090 at 0529 in SS. (Jeffery, NY)

CHINA—China Radio Int'l, 11715 via Mali at 0055 and 17755 at 0131 in SS via Brasilia. (Vaage, CA)

COLOMBIA—Caracol Colombia, Bogota, 5075//6150 at 0625 with phone calls, commercials, ID, news, from 0625. (Pellicciari, CT)

La Voz del Cinaruco, 4865 at 1043 in SS. (Wms, TX)

Ondas del Meta, 4885 at 0314 in SS. Also at 1044. (Wms, TX)

Radio Super, 6065 at 0521 in SS. (Jeffery, NY)

COSTA RICA—Radio Reloj, 4832 at 1117 with news in SS and clock ticks in background. (Wms, TX)

Faro del Caribe, 5055 at 1127 in SS; 9645 at 0434 with poetic readings in SS. (Wms, TX)

RFPI, 7385//9400USB//15050 at 0122 in SS; into EE at 0134. (Lamb, NY)

Adventist World Radio, 6150//7375//9725//13750 at 2338 in EE. (Lamb, NY) 9725 with SS ID "La Voz Adventista." (Wms, TX) 13750 at 0001 in EE. (Jeffery, NY)

Radio Exterior Espana relay, 5970 at 0300 in SS; 11815 at 1403 in SS. (Wms, TX) 17870 in SS at 0011. (Vaage, CA)

CUBA—Radio Rebelde, 5026 at 0330 with IS, ID, music in SS. (Wms, TX)

Radio Havana Cuba, 6000 at 0145. (Gillihan, AR) 6060 at 0356 in SS, 6180 at 0405, 9505 at 1422, 9550 at 0330 (Wms, TX) 6000//9820 at 0312 with "Jazz Place." (Pappas, SD) 9830 USB at 0100. (Pellicciari, CT) 11875 at 0252 in SS. (Foss, AK)

DOMINICAN REPUBLIC—Onda Musical, 4779

in SS at 0023 with music and ID. (Jeffery, NY)

ECUADOR—HCJB, 6205 at 0406 in unidentified language, 9745 at 1144 in JJ; 15140 at 1659. (Wms, TX) 9745 at 1148 in JJ, into SS at 1200. (Jeffery, NY) 0200. (Gillihan, AR) 15140 at 0220 in SS. (Foss, AK) 15490 at 1733. (Wilden, IN)

Estereo Carrizal, 3260 at 0418 with vocals, time checks, sports scores, IDs, flutes, announcements. Gone at 0509 recheck. (Paszkievicz, WI)

Radio Alianza, 5453v in SS at 0120 with ID, slogans, religious music, national anthem and off 0300. This is an unlicensed station in Imbabura Province. Very professional announcer. (Rausch, NJ)

Radio Baha'i, 4950 at 1123 in SS. (Wms, TX)

Radio Popular, 4800 in SS at 0240 with chorus, ballads. (Wms, TX)

Radio Quito, 4920 at 0220 with IDs, talk about border conflict with Peru. (Rausch, NJ) 0320 chorus, marimbas, SS. (Wms, TX)

EGYPT—Radio Cairo, 9900 at 2200. (Pellicciari, CT) 0351 in AA. (Wms, TX)

ENGLAND—BBC, 6005 at 0649 to Africa and 9600 with Network Africa at 0613. (Wilden, IN) 9600 at 0440. (Gillihan, AR) 11865 at 1401 in EE/unid, 15070 at 1240 and 17695 at 1313. (Wms, TX)

ETHIOPIA—Radio Fana (Torch) on 9335 in Amharic at 0327 sign-on with IS, ID, presumed local music, then country music at 0356. (Rausch, NJ)

FINLAND—Radio Finland, 9635 at 0435 with possible Finnish for Russians and some responsive answering from a small audience. (Wms, TX)

FRANCE—RFI, 5945//9790 at 2300 in FF. (Pellicciari, CT)

5945 at 02158 in FF. 15300 to Africa at 1252 in FF and 15365 to NA; 17850 at 1322 to Africa. 17780 at 1318 in FF. (Wms, TX)

9790 at 0155. (Gillihan, AR) 15365 at 1215 and 1305 in FF. (Northrup, MO) 15365//17575 at 1508-1557 sign-off with ID, EE schedule. (Pappas, SD)

FRENCH GUIANA—RFI relay, 13625 at 1237, 13640 at 1239, 17560 at 1307, all in FF. (Wms, TX) 15365//17860 in SS, into FF at 1430. (Lamb, NY)

China Radio Int'l relay, 11677 (nominal 11680, ed.) at 0358 in CC. (Wms, TX)

GABON—Africa Number One, 17630 at 1309 in FF. (Wms, TX)

Radio France Int'l relay, 4890 at 0409 in FF. (Wms, TX)

GERMANY—Deutsche Welle, 0600 with news; 17812 at 0230 (nominal 17810 and listed via Antigua, ed.) in GG. (Wilden, IN)

13780 in GG at 1220 and 15725 (via Antigua, ed.) in GG. (Northrup, MO) 15135 at 1658, 15415 at 1709 and 17560 at 1307 in GG. (Wms, TX)

GHANA—Ghana Broadcasting Corp., 3366 at 0451 with music, discussion, news, IDs, drumming IS. (Pappas, SD)

GREECE—Voice of Greece, 6260//7448 at 0130 with EE news. (Pellicciari, CT) 6260//7448//9935 at 0141 in EE, into Greek at 0144. (Lamb, NY)

GUATEMALA—Radio Buenas Nuevas, 4779.8 at

Abbreviations Used in Listening Post

AA	Arabic
BC	Broadcasting
CC	Chinese
EE	English
FF	French
GG	German
ID	Identification
IS	Interval Signal
JJ	Japanese
mx	Music
NA	North America
nx	News
OM	Male
pgm	Program
PP	Portuguese
RR	Russian
rx	Religion/ious
SA	South America/na
SS	Spanish
UTC	Coordinated Universal Time (ex-GMT)
v	Frequency varies
w/	With
WX	Weather
YL	Female
//	Parallel Frequencies

1149 in local language, children singing, talk, ID 1159. (Pappas, SD) 1115 in SS with IS, ID. (Wms, TX)
 Radio Maya de Barrillas, 3325 at 0232 with chorus, guitar. SS. Also 1104 in Mayan. (Wms, TX)
 Radio Tezulutlan, 4836 at 0309 with marimbas, chorus, ballads, SS. (Wms, TX)
 Radio Cultural, 3300 at 0257 with SS religion programming. Also 5955 at 1104 in SS. (Wms, TX)
 Radio K'ekchi', 4845 at 0240, marimbas. (Wms, TX)
 Las Voz de Nahuala, 3360 at 1105 in SS. (Wms, TX)
 Adventist World Radio, 5981 in SS at 1215 with religious talk, hymn, ID, address. (Lamb, NY)
HAWAII—KWHR, 17510 at 0011 with religious talk show. (Jeffery, NY) 0200. (Vaage, CA)
 WWVH, 15000 time signals at 0416. (Jeffery, NY)
HONDURAS—Radio Luz y Vida, 3250 at 0300, IS, guitar and religious music. (Wms, TX)
 La Voz Evangelica, 4820 at 0308, religious programs in SS. (Wms, TX)
 Radio Internacional, 4931 at 0245 with comedy program in SS. (Wms, TX)
HONG KONG—BBC relay, 15280 at 0029. (Vaage, CA)
INDONESIA—RRI Jakarta, 9525, 1419 with music, slow songs in unidentified language. (Wms, TX)
 RRI Tanjungkarang, Sumatera, 3395 at 2300 in II with "Song of the Coconut Islands" IS and ID, presumed news. (Rausch, NJ)
 RRI Gorontalo, Sumatera, 3265 at 1039 in unidentified language. (Foss, AK)
ISRAEL—Kol Israel, 7465 at 0415 with news. (Gillihan, AR)
ITALY—Radio Roma, 7275 at 0507 in II. (Jeffery, NY)
 RAI, 9515 at 0954 in II. (Jeffery, NY) 9905 at 0529, possibly via Fr. Guiana. (Vaage, CA)
JAPAN—Radio Japan, 5960 (via Canada) at 0355. Off at 0400. (Wilden, IN) 0115 with ID. (Gillihan, AR) 9535//9750//11705 (via Canada) at 1400. (Pappas, SD) 11895 at 0310 with news. (Gillihan, AR) 11925 at 2100. (Yohnicki, ON) 17810//17845 at 0104. (Vaage, CA)
 Radio Tampa, 3925 at 1027 in JJ with classical music. (Foss, AK) 1108 man and woman in JJ. (Wms, TX)
JORDAN—Radio Jordan, 11940 at 2153 with ID at 2200. AA. (Pellicciari, CT) 0403 in AA. (Wms, TX)
KAZAKHSTAN—Goloss Rossii via Kazakhstan, 13605 at 0253 with religious service. (Wms, TX)
KUWAIT—Radio Kuwait, 9840 at 0240 in AA. ID included "al Kuwait" at 0300. (Julian, TX) 2230 in AA. (Pellicciari, CT) 9840//11990 at 1921 in EE/AA. (Pappas, SD)
MADAGASCAR—Radio Netherlands relay, 9890 at 1406, 11655 in DD at 0356. (Wms, TX)
MALI—China Radio Int'l relay, 9710//11715 at 0023. (Lamb, NY) 11715 at 0055. (Vaage, CA) 0400 with IS, ID in EE, CC and continued in CC. (Wms, TX)
MALTA—Deutsche Welle relay, 9690//11905 (Nauen) at 2058 in AA with ID, cello, IS, ID, news. (Lamb, NY)
MEXICO—Radio Educacion, 6185 at 0630 with SS/EE ID "XEPPM Radio Educacion, Mexico." (Pellicciari, CT) 0404 news in SS. (Wms, TX)
 Radio Mexico Int'l, 9705 at 1411 with news in SS. (Wms, TX)
 Radio Mil, 6010 at 1343 with news in SS. Also 0349. (Wms, TX)
 Radio Universidad, San Luis Potosi, 6045 at 0355 with music and talk in SS. (Wms, TX)
 Radio Universidad Hermosillo, 6115 at 0424 in SS. (Wms, TX)
MOROCCO—RTV Marocaine, 15335 at 1254 with music, AA. 15345 at 1706 in AA. (Wms, TX)
 VOA relay, 11915 (/Botswana-9815) at 2104 in FF. (Lamb, NY)
 15410 at 1708 with news. (Wms, TX)
NETHERLANDS—Radio Netherlands, 6020 at 2330. (Pellicciari, CT) 11655 at 1932 with news, weather. (Wilden, IN)
NETHERLANDS ANTILLES—Radio Netherlands via Bonaire-6165//9840 at 2330. (Pellicciari, CT) 6165 at 0401 in SS. Also 15120//17605 at 1655 in DD. (Wms, TX) 9590 at 0430 with program schedule. (Gillihan, AR)
NEW ZEALAND—Radio New Zealand Int'l, 9700



**SOCIALIST REPUBLIC OF VIETNAM
 RADIO THE VOICE OF VIETNAM**

Verification

To... **MR... EDOUARD... S... PROVENCHER**.....
 Thank you for your Reception at... **5.00 UTC**..., on **Feb. 2... 1995**
 on... **5.94.0... kHz**..... All details of
 your Report of Reception correspond well with our station log. With the
 compliments of the Director of the Overseas Service of the Voice of Vietnam.

Maine

OVERSEAS SERVICE, VOICE OF VIETNAM

58 Quan Tu Street, Hanoi

*Ed Provencher in Maine got an early reply from the Voice of Vietnam for their new
 relay over Voice of Russia transmitters.*

at 0751. (Snyder, OK) 11900 at 0458 with IS, ID, news. (Jeffery, NY)
 15115 at 0138 with classical music program. (Lamb, NY) 0226. (Foss, AK)
NIGER—La Voix du Sahel, 5019 at 0415, two men in FF. (Wms, TX)
NIGERIA—Radio Nigeria, Kaduna, 4770 at 0440 with news, local music. (Yohnicki, ON)
NORTH KOREA—Radio Pyongyang, 13850 at 2345. (Vaage, CA)
NORWAY—Radio Norway Int'l, 13800 at 1215

in NN, ID. (Northrup, MO)
OMAN—Radio Oman, 15375 at 1257 with boogie-woogie music. (Wms, TX)
PAPUA NEW GUINEA—NBC Port Moresby, presumed, 4890 at 1046. (Wms, TX) 1002 with news, country, commercials, time checks, Karai Service ID at 1059. (Pappas, SD)
PARAGUAY—Radio Nacional, 9735 at 0145 in SS with ID, announcements. (Pellicciari, CT)
PERU—Radio Concordia, 6141 in SS at 1122. (Wms, TX) (Is this active? ed.)

53,226
ELECTRONIC COMPONENTS
 Whether you order 1 part or all 53,226...MOUSER stocks and...ships same day!!
CALL... (800) 992-9943
 For your FREE 316pg. Catalog
MOUSER® ELECTRONICS
 958 North Main St. Mansfield, TX 76063

READER SERVICE CARD

 Use Your Free Reader Service Card
 For More Information On Companies Advertising In This Issue.

Motron 310 Garfield St Suite 4
 PO Box 2748
ELECTRONICS Eugene, Oregon 97402
The Ultimate Signals Intelligence Tool!
TxID-1
TRANSMITTER FINGERPRINTING SYSTEM
 Every carrier operated radio has a "FingerPrint" when keyed. The TxID-1 captures, stores, compares and analyzes those FingerPrints. Includes CTCSS, DCS and DTMF decoding, Deviation measurements, Spectrum Occupancy (with some receivers) plus more! System includes PC plug-in board and software. Call for Brochure.
 Now Shipping TxID Software Version 2.0 featuring Auto-Compare and Auto-Match capabilities
 TxID™ TxPorter™--Now you can go Mobile with the TxID-1! The TxPorter accepts the TxID-1 card and provides a parallel interface to your Laptop computer. The TxPorter™ requires 12VDC and can be plugged into your car's cigarette lighter.
TxID-1 FINGERPRINTING SYSTEM \$699.00 PLUS
TxPorter™ Mobile Adapter \$249.00 S/H
 Price and Specifications subject to change without notice
 Info: (503) 687-2118 Fax: (503) 687-2492
 Visa, MasterCard, Discover & American Express Accepted
 Receive our on-line catalog via the Internet at motron.info@emerald.com

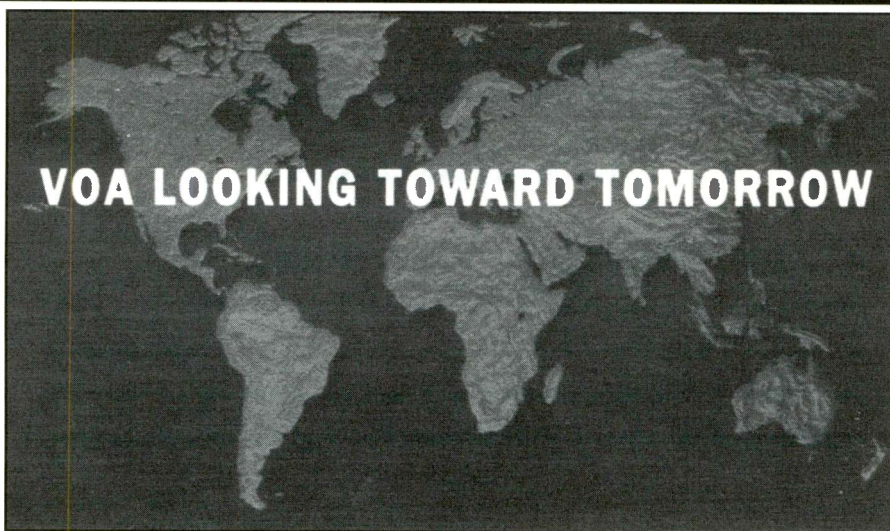

This 1994 holiday QSL card from the VOA featured white letters over a green map and a dark blue (almost black) background.

Radio Union, Lima, 6115 at 1118 with ID, SS. (Wms, TX)
 Radio Eco, Iquitos, 5097 at 1050. Ballads, SS. (Wms, TX)
 La Voz de la Selva, 4824 at 1039, music and SS. (Wms, TX)
 Radio Cora, 4914 at 1049, talk in SS. (Wms, TX)
 Radio Continental, Arequipa, 6055 presumed with talks in SS at 1139. (Wms, TX)
 Radio Imperial, 6544v at 0050 in SS with ID, echo comunicados, commercials. Address given as Calle de Ayabaca 339-341, Huancabamba, Peru. (Rausch, NJ)
 La Voz de Andamachay, 5547v in SS at 0020 with old U.S. pop and Peruvian music, time check, ID at 0056. 10 minutes of South American news at 0128. Address: Senor Fernando Vasquez Castro, Jiron Jose Galvez 730, Celendin, Peru. (Rausch, NJ)
 Radio Altura, 3340 at 0330 with SS talk, music bridges, Peruvian music, sound effects, yipping, IDs, time check. (Paszkiwicz, WI)
PHILIPPINES—VOA relay, 6110 at 1107 and 1339. (Wms, TX 17820 at 0014. (Vaage, CA)
PORTUGAL—Radio Portugal, 9570 at 0130 with news. (Pellicciari, CT) 15200 at 1246 with swing music. Also 17745 at 1315 to Central America in PP. (Wms, TX)

Deutsche Welle relay, 9535 at 0325. (Wms, TX) 9615, //6040 and 6145 (Germany) and 15105 (Antigua) at 0013 in SS. (Lamb, NY)
 RFE/RL at 0344 in RR. (Wms, TX)
QATAR—Qatar Broadcasting Service, 9585v in AA at 1840 with romantic middle eastern ballads, 5 plus I time pips and ID "Idha" at at Qatar min al Doha" at 1900, then news. Off 2124 with anthem. (Rausch, NJ)
ROMANIA—Radio Romania, 9510 at 0323 in SS. (Wms, TX)
RUSSIA—Voice of Russia, 9840 at 0945 in CC. (Jeffery, NY)
 11750 at 2120. (Pellicciari, CT) 12070 at 2124. (Lamb, NY) 15475 from Armavir at 1304 to Africa in GG and 17765 at 1316 in unidentified language. 17685 at 1311 in Asian language. (Wms, TX)
 17665 at 0139. (Vaage, CA) I sent for a QSL from the Voice of Russia but received a Radio Moscow card with the old name crossed out and "Voice of Russia" written in. (Wilder, IN)
 Golos Rossi, 13680 at 1239 in RR. (Wms, TX)
 Radio Nadezhda, 9490 at 1157 in RR, some talk, much music. ID. (Pappas, SD)
RWANDA—Radio Rwanda, 11655 at 2012 with man and woman talking about genocide within the

country and urged listeners to "think about it." Broadcast was in EE/FF. (Wilden, IN)

SAUDI ARABIA—BSKSA, 15175 at 1244 in AA, 15345 at 1255 in AA. (Wms, TX)

SINGAPORE—BBC relay, 9740 at 1408. (Wms, TX) 17790 at 0202. (Vaage, CA)

SLOVAKIA—Radio Slovakia, 7298 at 0130 sign off. (Gillihan, AR)

SOUTH AFRICA—Channel Africa, 11900 at 0519. (Vaage, CA)

SOUTH KOREA—Radio Korea, 15575 at 0117 with talk and music. (Pappas, SD)

SPAIN—REE, 6055 at 0100 in SS, 9540 at 0100 in EE. (Pellicciari, CT) 15110 at 1243 in SS, 15380 in SS at 1707

17845 at 1320 in SS. (Wms, TX) 17870 in SS at 0011 via Costa Rica. (Vaage, CA)

China Radio Int'l relay, 9690 at 0339 with program on culture in China. (Wms, TX)

SUDAN—Radio Omdurman, 9200 in AA at 2120. (Yohnicki, ON)

SWEDEN—Radio Sweden, 15240 at 1250 with talk about a rural celebration. (Wms, TX)

SWITZERLAND—Swiss Radio Int'l, 5890 at 0030 in GG. (Gillihan, AR) 6135 in II at 0311. (Wms, TX) 9705, "Arts and Culture" at 0430. (Pellicciari, CT) 9905 at 0403 with news. (Wilden, IN)

SYRIA—Syrian BC/Radio Damascus, 9950 at 0444 in AA. (Wms, TX) 15095 presumed, at 1345 in AA with local music, Koran, possible ID, pops. (Lamb, NY)

TAIWAN—Voice of Free China, 5950 (via WYFR) at 0712. (Wilden, IN) 7130 at 1133 in JJ. (Wms, TX) 9680 (via WYFR) at 0205. (Gillihan, AR)

Voice of Asia, 7445 at 1138 with news. (Wms, TX)

TANZANIA—Radio Tanzania, 5050 at 0331 with news. (Wms, TX)

UKRAINE—Radio Ukraine Int'l, 11780 at 2115 remembering Chernobyl. (Pellicciari, CT) 11950 at 2114 with talks, ID. (Lamb, NY)

UNIDENTIFIED—9820 at 0708—seemed to be a time standard station with Spanish underlying it. (Wilden, IN) 15140 at 0000-0500 in SS, included football game. (Pellicciari, CT)

UNITED ARAB EMIRATES—Abu Dhabi, 9605//9770//11710 at 2300 with news. (Pellicciari, CT) 11885 at 0449 in AA, 17645 at 1310 and 17855 at 1323 in AA. (Wms, TX)

UZBEKISTAN—Radio Tashkent, 5060 in GG at 2057 with IS, ID, international news, vocals. (Rausch, NJ)

VANUATU—Radio Vanuatu, 3945 in pidgin at 0950 with religious program to 1005 close. (Rausch, NJ) 1032 presumed. (Wms, TX)

VATICAN—Vatican Radio, 9725 at 0345 in Italian and EE. (Wms, TX)

VENEZUELA—Ecos del Torbes, 4980 at 0247 and 1125, SS. (Wms, TX)

Radio Nacional, 9549 at 00327 in SS. (Wms, TX)

Radio Tachira, 4830 in SS at 0311. (Wms, TX)

Radio Rumbos, 9650 at 1140, winning lottery numbers in SS. (Wms, TX) (nominal 9660, ed.)

YUGOSLAVIA—Radio Yugoslavia, 7115 at 0015 with news. (Pellicciari, CT) News at 0445. (Gillihan, AR)

That's a wrap for this time. A sweeping bow and mighty cheer to the following folks who made it work this month:

Joey Gillihan, Bono, AR; Sheryl Paszkiewicz, Manitowoc, WI; Mark Northrup, Gladstone, MO; Steve Williams, Corpus Christi, TX; Marty Foss, Wasilla, AK; Mike Yohnicki, London, ON; Margaret Snyder, Norman, OK; Maria Pappas, Huron, SD; Bjorn F. Vaage, Granada Hills, CA; Ed Rausch, Cedar Grove, NJ; Steve Pellicciari, Norwalk, CT; Marie Lamb, Brewerton, NY; Jerrel H. Julian, Lubbock, TX and Sue Wilden, Columbus, IN. Thanks to each one of you.

Until next month—good listening! ■

PAY TV AND SATELLITE DESCRAMBLING
 all new info **VOLUME 6** all new info
Volume 6: Our entire collection of all current cable satellite and wireless turn-ons.

- Pay TV Volumes 1-5 (all different Vol. 1 basics)
- Wireless Cable Hacking
- Complete Wizard (VCII+)
- Satellite and DBS Handbook (includes Hacker info)
- Hacker Video
- Cellular Phone Hacking

\$15.95 each or 3/\$34.95 or 5/\$52.95
 Newsletter \$29.95/12 issues. Catalog \$1.
 All our info \$129.95 (includes sub)

SCRAMBLING NEWS
 3494 DELAWARE AVENUE, BUFFALO, NY 14217-1230
 Voice/FAX (716) 874-2088 BBS (716) 871-1915

CIRCLE 78 ON READER SERVICE CARD

CB RADIO OWNERS!

We specialize in a wide variety of technical information, parts and services for CB radios. 10-Meter and FM conversion kits, repair books, plans, high-performance accessories. Thousands of satisfied customers since 1976! Catalog \$3.

CBC INTERNATIONAL
 P.O. BOX 31500PC, PHOENIX, AZ 85046

PROFESSIONAL 10 HOUR RECORDER. Built like a **BATTLESHIP**



- * Special Pop'Comm price \$149
- * Heavy Duty commercial recorder (NOT "improvised" from a consumer model)
- * Full one year warranty * Dimensions 11.5 x 7 x 2.75"
- * BUILT-IN voice activation: add \$25
- * Also available: 12, 14 and 16 hour models
- * Recorders come with full applications info for scanners, etc.

FREE 32 Page Special Equipment Catalog



VIKING INTERNATIONAL SINCE 1971
 150 EXECUTIVE PARK BLVD. #4600
 SAN FRANCISCO, CA 94134
 PHONE: (415) 468-2066 FAX: (415) 468-2067

No shipping charges on prepaid orders. COD's OK. Cal. residents add tax. Sorry, no credit cards (all they "do" is increase prices---)

CIRCLE 84 ON READER SERVICE CARD

WASHINGTON PULSE

FCC ACTIONS AFFECTING COMMUNICATIONS

Inspection of Radio Installations on Cargo and Passenger Ships

The FCC is seeking information to compile a record to be used in reviewing its current rules regarding the inspection of ships for compliance with the Communications Act and the International Convention for the Safety of Life at Sea. The commission says this inquiry is the first step to developing and implementing an overall strategy to improve the manner in which it conducts inspections without derogating the safety of life at sea.

Specifically, the commission is seeking information that will allow it to streamline ship inspection procedures for the maritime services, remove unnecessary rules, to improve service to the maritime community, and more importantly, preserve maritime safety.

The Communications Act requires the commission to inspect the radio installation of large cargo ships and certain passenger ships of the United States at least once a year to ensure that the radio installation is in compliance with the requirements of the act. Additionally, the act requires that the FCC inspect the radio installation of small passenger vessels to ensure compliance with the radio installation requirements of the Communications Act. Currently, the commission inspects small passenger ships once every five years.

The commission proposed two marine-related amendments to the Communications Act. The first amendment allows early implementation of the Global Maritime Distress and Safety System (GMDSS). The second proposal will permit changes to the way the commission inspects large cargo vessels. In 1988, the Safety Convention was amended to incorporate the equipment and principles of the GMDSS. The amendments incorporated advanced terrestrial data systems, as well as satellite communications systems, and changed the distress alerting system from primarily ship-to-ship, to primarily ship-to-shore. The GMDSS amendments entered into effect in 1992 and are to be phased in with full implementation by 1999.

The commission believes that it is both necessary and timely to commence a thorough review of the policies, rules and procedures used to regulate the inspection of compulsory complete record that will allow the commission to improve current inspection processes, develop a technically sufficient regulatory environment for the inspection of ships subject to the GMDSS, and provide an overall strategy on how best to utilize private sector entities to inspect compulsory ship stations.

Local Satellite Antenna Regulations

The commission proposed to change its policies on federal preemption of local land-use regulations that inhibit access to satellite communications. The revised rule is intended to provide satellite antenna users, and state and local governments with greater certainty about the extent to which zoning ordinances, building codes or other non-federal laws may impinge upon the federal interest in facilitating each citizen's access to increasingly important satellite communications technologies.

In resolving these issues, the commission faced a conflict between two important principles. On one hand is a strong federal interest in promoting access to nationwide communications on a fully competitive basis. On the other hand is the principle of federalism, which is particularly weighty in the case of land-use restrictions because those restrictions lie at the core of state and local police powers. The commission's proposals are an attempt to balance these significant interests.

The commission's existing rules generally preempt any local ordinance that differentiates between satellite and non-satellite antennas, unless the ordinance is a reasonable means of achieving a local health, safety, or aesthetic objective and the ordinance does not impose excessive costs or unreasonably inhibit reception. Since the existing satellite antenna preemption rule was adopted in 1986, the FCC has continued to receive consumer complaints about local regulations. But the commission has refused to review local regulations until after all other remedies, including judicial remedies, have been exhausted. A 1993 decision of the U.S. Court of Appeals for the Second Circuit called this "exhaustion" policy into question by holding that once a judicial decision on an ordinance has been rendered, the commission has no jurisdiction to render a conflicting opinion.

The action responds to the 1993 court ruling by proposing to permit satellite antenna users to seek commission review before they pursue any judicial remedies. However, in order to minimize federal intrusion into local affairs and avoid becoming a "national zoning board," the commission also proposed substantive modifications designed to clarify the rule and make it easier to administer. Among other things, the proposed modifications would:

- clarify and straighten the basic test of reasonableness set forth in the existing rule;
- create rebuttable presumptions of unreasonableness that would apply to dishes less than one meter in diameter, as well as to two-meter dishes in certain commercial or industrial areas; and

- create a waiver procedure by which local governments can seek exemptions for nonconforming ordinances justified by special circumstances (such as the historic character of a particular area).

The commission hopes these proposed changes will provide greater certainty in the reasonableness test, enabling localities to enact and enforce zoning policies that accommodate federal interests while preserving local autonomy.

Also before the commission were petitions by satellite interests for an immediate declaratory interpretation of the existing rule that would impose a stricter, "per se" approach to preemption of land-use regulations. The commission received comments on these petitions from satellite antenna users and manufacturers, satellite service providers, and representatives of local governments. The commission tentatively decided not to adopt any form of "per se" preemption, based in large part on the government. However, the commission responded to the requests for immediate relief by announcing that it would entertain, on an interim basis, petitions by declaratory relief in particular cases under the existing rule.

In formulating the proposals, the commission attempted to address the problems it perceived in the least restrictive or intrusive way possible. The changes are intended to minimize costs on local governments and antenna users, and to accommodate the interests of both. The commission's goals in proposing its rule are to promote healthy competition and to facilitate access to satellite-delivered services.

HF Digital Communications in the Amateur Service

As part of its commitment to provide the maximum flexibility to the amateur community, the commission has amended its rules to permit automatic control of stations transmitting digital emission types on the high frequency (HF) amateur service bands.

The automatically controlled station either must be connected to another station under manual control, or must transmit within a subband designated for this purpose. Automatic control of stations transmitting digital emission types enable amateur operators to utilize high-speed computer-based message technology for the rapid and accurate relaying of messages and data.

The commission believes these rule changes will allow the amateur community to contribute to communication technology and to advance its communication and technical skills consistent with the rules. ■

COMMUNICATIONS CONFIDENTIAL

YOUR GUIDE TO SHORTWAVE "UTILITY" STATIONS

Robert Pettengill, OK, updates his earlier information concerning Herb Hilgenberg Southbound II. "Herb is back on the air in Burlington, Ontario, Canada, giving his invaluable service to sailors in the Atlantic Ocean."

Robert sent an article from the April 1995 issue of *Cruising World* magazine that indicated Herb had obtained a Canadian Coastal radio station license and once again was providing daily individualized weather forecasts to boats at sea. The article stated: "Herb's broadcast schedule for vessels south of 37 degrees is: 12359 kHz from 2000 to 2200 UTC. At 2100 UTC, Herb briefly shifts to 8294 kHz to check for traffic north to 37 degrees. If there is no traffic, he shifts back to 12359 kHz and stands by until 2200 UTC. The schedule may be altered somewhat in the spring to accommodate boats north of 37 degrees.

"Dedicated to providing accurate weather information to mariners, Herb is financing his new Canadian-based operations from his savings. Contributions may be sent to Herb Hilgenberg, 5468 Hixon Avenue, Burlington, Ontario, L7L 3S2 Canada.

Some ute buffs will be interested to learn of the declassification of another U.S. Government training manual. Formerly known as the Department of the Air Force *Manual AFM 100-80* and Department of the Army *Technical Manual TM 32-250*, the book is titled, *Fundamentals of Traffic Analysis (Radio Telegraphy)*.

Traffic Analysis involved the study of communications to determine the organization and operation of a communication system. For further details about this and other titles, request a catalog from Aegean Park Press, P.O. Box 2837, Laguna Hills, CA 92654.

A recent news release from Globe Wireless of Half Moon Bay, CA, carries a request for help from radio officers and short-wave listeners.

"Globe Wireless is constructing a worldwide network of radio stations for maritime data communications. Coast stations located in San Francisco (KFS), New Orleans (WNU), and Newfoundland (VCT) are on the air. Additional stations in Hawaii (KEJ), New Zealand (ZLA), and Sweden are under construction, with more to follow.

"Reception data from numerous receiving locations worldwide is needed to confirm the coverage area of the network, and especially the newer stations. For this reason, the Globe Wireless Engineering Department is requesting assistance from interested listeners.

"Every listener is eligible to receive one QSL card for each Globe Wireless coast



The KMI High Seas Radiotelephone Receiving Station, located at Point Reyes, California, is pleased to acknowledge your reception of one of our transmissions on:

Date: 12-12-94

Time: ?

Frequency: 13080.0 KHZ

Mode: USB

KMI transmits with 10kw on directional Rhombic and Log Periodic antennas located at Dixon, California, in the 2-22 MHz bands for High Seas Radiotelephone Service.

We wish you continued success in the radio communications field.

2-14-95
 Signature Date

TREVOR:
THANK YOU FOR
THE RECEPTION
REPORT. HOPE YOU
ENJOY THE INFO.
73 & GOOD
DX!

GREG



Trevor Fletcher, Alberta, Canada shares this QSL with POP'COMM readers.

station received and correctly reported. Reports are needed from ships at sea, as well as listeners on shore."

"We find reception reports from listeners extremely useful," said Rod Deakin, chief engineer, Globe Wireless. "They include valuable technical information and we are happy to send QSL cards in return.

"Globe Wireless SITOR transmitters can be easily recognized. They broadcast a unique 'free signal' pattern, followed by the station's call sign, when not otherwise in use. Similarly, available CW transmitters broadcast a repetitive 'wheel' including the call sign and other information. The six traditional maritime HF bands—4, 6, 8, 12,

16, and 22 MHz—are utilized by Globe Wireless stations."

Elsewhere in the column are details for the required information, mailing address, and a sample of the QSL card.

A letter from Tom Severt, KS, describes some interesting observations: "I've been hearing a lot of scrambled speech that sounds to me like speech-inversion scrambling. All of my loggings of scrambled speech this month are of this type. Occasionally, I have heard them whistling, and rolled Rs that sound like Spanish-speaking stations.

"On 6797 at 0250, right before the YL/SS sked, there was some more distorted

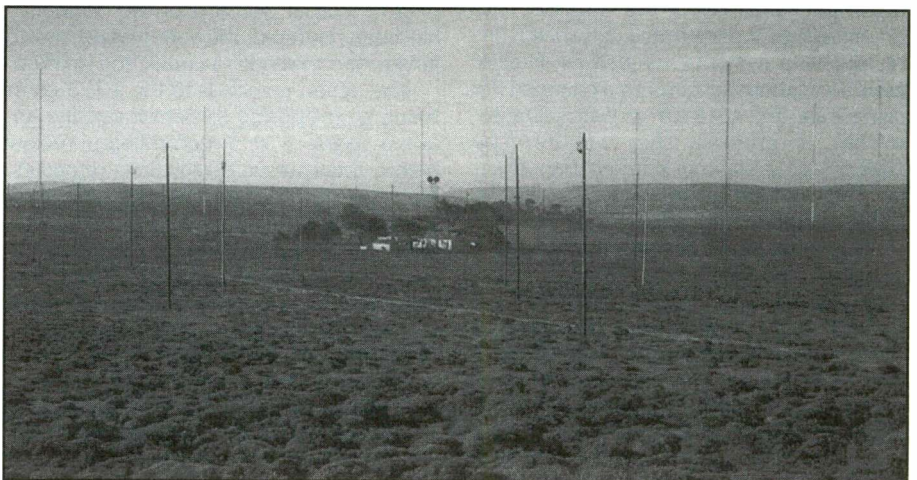

Portion of KMI antenna farm. Photo from AT&T and sent in by Trevor Fletcher, Alberta, Canada.

WRTH
BEST RECEIVER 1992

As changing world events bring us all closer, it's exciting to get the news direct from a foreign station. So tune in and listen – even when you're 12 time zones away. The drama of survival efforts. Crisis monitoring when conventional communications break down. The uncertainty of economic trends. And colorful cultural activities.

Don't wait for someone else to tell you what's happening. The FRG-100 Worldwide Desktop Communications Receiver puts you in the action now! The FRG-100 is a winner, too. It won the prestigious WRTH award for "Best Communications Receiver" in December 1992. No surprise with exclusive features like adjustable SSB carrier offset and selectable tuning steps in 10, 100 and 1000 Hz.

But you're the real winner! Priced lower than receivers with fewer features costing much more, the FRG-100 delivers extraordinary, affordable performance. For news and entertainment from far away places – a little closer than before – listen to the FRG-100 at your Yaesu dealer today.

YAESU

Performance without compromise.SM

FRG-100 Worldwide Desktop Communications Receiver

- Covers all short-wave bands including 50 kHz-30 MHz
- 50 Memory Channels
- Twin 12/24 Hour Clocks
- Programmable On/Off Timers
- Selectable Tuning Steps (10, 100, 1000 Hz)
- Built-in Selectable Filters 2.4, 4, 6 kHz (250 or 500 Hz options)
- Dual Antenna Connections (Coax and Long Wire)
- Bright LCD Display
- Operates on AC or DC
- Compact Desktop Size
- Memory or Group Scanning
- 16 Preprogrammed Broadcast Bands



Yaesu helps bring the world a little closer.

© 1994 Yaesu USA, 17210 Edwards Road, Cerritos, CA 90701 (310) 404-2700

Specifications subject to change without notice. Some accessories and/or options are standard in certain areas. Check with your local Yaesu dealer for specific details.

Spanish-language programming. Close to the top of the hour, I distinctly heard a YL say, 'Radio Habana Cuba.' This really doesn't come as much of a surprise as available information indicates many cut numbers are operated by Cuban Intelligence (DGI) and similar mistakes have been reported in the past.

"I copied one of the Russian MFA RTTY transmissions, JMS, at 2230 on 16841.2 kHz. Instead of the usual 'QRU QRU SK SK' sign-down, they instead sent 'TTTTT.' That kind of sign-down was used by KGB-sponsored numbers stations and apparently still is used by them on whatever they

are calling themselves today."

AZZ, IL, writes, "I snagged these loggings by climbing up on a silo with a RS DX-392 and a 100-foot longwire held aloft by a surplus weather balloon. I used the lightning rod for a ground. I wasn't paying attention to the weather until my hair stood on end. From experience (tower repair), I knew that lightning was due immediately. I got down just in time. Lightning struck a nearby tree. My monitoring location was about 45 miles due west of Chicago's O'Hare International Airport.

"Do numbers stations move frequently? The one I'm trying to track (4470 kHz at

0100 UTC) seems to move every 7 to 10 days."

There've been reports of certain numbers stations changing locations; one such station reportedly was on board a ship.

Rick Baker, OH, has started seeking reception verifications from foreign warships. He recently added the Royal Swedish Navy and the Royal Australian Navy to his catches, and now he has warships verified from eight countries.

I have been asked about the difference between callsigns and routing indicators. The former is a combination of characters, letters, and/or numbers, which are used as the means of identifying the correspondents in a radio net. Callsigns usually are placed prior to the message heading or appear as the callup when establishing contact with another station.

A routing indicator is an address or group of characters placed in the message heading to specify the final circuit or terminal where the message is to be delivered.

**UTE Loggings: SSB/CW/RTTY/SITOR/etc.
All Times in UTC.**

201: Beacon RI, Riviere Du Loup, PQ, Canada at 0814. 438 mi., Beacon YKX, Kirkland Lake, Ont., Canada at 0918. 623m. (AH)

203: Beacon NSI, San Nicholas Island OLF, CA at 2231. (BV)

207: Beacon UEM, Egg Island LS, BC, Canada at 0946. (SF)

212: Beacon PMX, Palmer, MA at 0621.0 70m. (AH)

217: Beacon LOP, Lakeport, CA at 1006. (SF)

220: Beacon HLE, Hailey, ID at 0952. (SF)

221: Beacon HM, Hamilton, Ont., Canada at 1008. 4587m; Beacon RQM, Ranglely, ME at 0900. 236m. (AH)

230: Beacon UCL, Cayo Largo Del Sur, Cuba at 1023. 1500m. (AH)

232: Beacon GT, Grand Turk island, BWI at 1001. 1389m. (AH)

256: Beacon UNV, Nuevas, Cuba at 0823. 1434m. (AH)

257: Beacon SQT, Melbourne, FL at 0741. 1070m. (AH)

264: Beacon RLS, Westerly, RI at 0431. 30m. (AH)

271: Beacon IBO, Idabel, OK at 0540. (PC)

272: Beacon PFH, Hudson, NY at 0546. (PC); Beacon UVR, Varadero, Cuba at 0955. 1402m. (AH)

278: Beacon RS, Worcester, MA at 0737. DSB; Beacon GPQ, u/i at 0817. 1000 Hz, peaks E/W; Beacon PQ, Presque Isle, ME at 0730. DSB. (PC)

281: Beacon ZSJ, u/i at 0752. (AH)

284: Beacon DPG, Dugway Proving Grounds, UT at 0843. (SF)

293: Beacon CRD, Conrad, MT at 0951. (SF)

296: Beacon SP, Wichita Falls, TX at 0858. DSB. (PC)

300: Beacon 3B, Brockville, Ont., Canada at 0702. 311m. (AH)

315: Beacon USR, Simon Reyes, Cuba at 0842. 1436m. (AH)

318: Beacon HFY, Indianapolis, IN at 0851. 786m. (AH)

323: Beacon SRC, Searcy, AR at 0429. (PC); Beacon BSD, Davids Head, Bermuda at 0704. 732m. (AH)

326: Beacon MCY, Mercury Desert Rock (near Reno), NV at 2243. (BV)

332: Beacon IA, Portland, OR at 0926; Beacon XH, Medicine Hat, Alberta, Canada at 0929. (SF)

335: Beacon CC, Concord, CA at 0928. (SF)

344: Beacon ZIY, Georgetown, Cayman Islands at 0936. 1648m. (AH)

350: Beacon ME, Chicago (O'Hare—Deana), IL at 0200. (AZZ); Beacon NUC, San Clemente Island



When seconds count, REACT® needs you...

...to summon help for an injured motorists, an elderly woman trapped in a fire, a trucker stranded in a blizzard, a drowning child!

As a REACT volunteer CB radio monitor you may be the only communications life-line for someone in serious trouble. You relay messages from those desperate for help to police or other emergency services.

Your REACT Team will also use CB and other radio services to provide safety communications for events like parades, marathons and even balloon races. The fellowship with other REACT members at Team meetings and annual conventions is an added bonus.

Volunteer. Join Today!

Add a New, Exciting Challenge to Your Life. Help Save Lives and Property!

REACT® International, Inc.

Tel (316) 263-2100

FAX (316) 263-2118

P.O. Box 998, Wichita, KS 67201



TWO POWERFUL



HAM RADIO VIDEO COURSES FROM ARRL

Everything you need to pass your Novice, Codeless Technician and General Class Amateur Radio license tests—plus Morse code. Guaranteed!

These breakthrough courses are fast, easy and fun!

Get the Best, When You Need the Best!

- Only the American Radio Relay League (ARRL), the national organization of Amateur Radio Operators, has more than 75 years experience in helping people—just like you—become hams. With our expert help, you'll be on the air in no time!
- ARRL Video Courses demonstrate every important concept on video. You succeed because you completely understand the material, not because of rote memorization.
- Only the ARRL has the resources to make sure you have the latest, most accurate information on video. With the ARRL, you know your course is fully updated for the current FCC exams.
- Your course is produced in association with King Schools, whose award-winning "Monster Graphics" let you see your instructor and "the action" at the same time.
- With the ARRL, expert help is only a phone call away. Call us any business day, toll-free, to have your questions about ARRL Video Courses or your FCC exam answered personally.



Here's What You Get—

Expert Information That's Easy to Understand!

TECHNICIAN CLASS COURSE (No Morse Code Required)

Your complete ARRL Technician Class Home Study Video Course Includes:

- Three exciting video tapes—five hours of invaluable instruction—covering everything you need to pass your Novice and Technician Class written exams.
- A 164-page Course Book with detailed notes.
- Every exam question—with correct answers and detailed explanations.
- Six practice exams to "tune you up" for the real thing. On the big day, you'll be more than ready!

GENERAL CLASS COURSE

Your complete ARRL General Class Home Study Video Course Includes:

- Three exciting video tapes—four hours of invaluable instruction—covering everything you need to pass your General Class written and Morse code exams.
- A 96-page Course Book with detailed notes.
- Every exam question—with correct answers and detailed explanations.
- Three practice exams to "tune you up" for the real thing. On the big day, you'll be more than ready!
- Morse Academy software—so you'll learn Morse code the right way, the Farnsworth way.

With our ironclad guarantee, you risk nothing!

We're so sure you're going to pass your Amateur Radio license tests with the ARRL Technician and General Class Video Courses that we make this exceptional guarantee:

1. Examine either course for 20 days. If it's not what you expected, simply return it for a full refund—no questions asked.
2. You will pass your FCC codeless Technician-class written exam within one year, or you can return your course for a full refund—every penny. Or, you will pass your FCC General-class written and Morse code exams within one year, or you can return your course materials for a full refund. You pass, or you don't pay! (Include a dated proof of purchase and the date and location of your VEC-administered exam session when you return your course.) And...
3. In addition, the veteran hams at ARRL Headquarters are available to answer your questions and provide expert advice and information. We're only a phone call away—and we won't let you fail!



Choose from 4 Great Deals:

1. Your ARRL Technician Class Video Course, only **\$99**
2. Your ARRL Technician Class Video Course, Plus The Technician Class Computerized Exam Review Software (a \$49 value), all only **\$119**
3. Your ARRL General Class Video Course, including Morse Academy Morse code training software, only **\$99**
4. Your ARRL General Class Video Course, Morse Academy software Plus The General Class Computerized, Exam Review Software (a \$49 value) all only **\$119**

To Order, Call 1-800-32-NEW HAM or Tear Out And Mail Today

OK! I want to start enjoying the World of Amateur Radio. Rush me:

- Complete Technician Class Video Course \$99
- Complete General Class Video Course \$99
- Extra Course Book Tech. Gen. (with course purchase only) \$19
- Complete Course And Computerized Exam Review Software Tech. Gen. All only \$119

Exam Review Software

- Macintosh IBM Compatible (512k, hard drive)
- Specify 3 1/2" 5 1/4" Disks

Order now and get in on the fun of Amateur Radio!

Ship To:
Name _____
Address _____
City _____
State, ZIP _____
Tel (____) _____

Charge To:
 MC VISA AMEX Discover
Card No. _____
EXP _____
 Check or Money Order Enclosed

TOTAL PURCHASE \$ _____

Shipping and Handling _____

- UPS Surface, \$5
- FEDEX 2-Day Delivery, \$15
- In CT add 6% Tax _____
- In CA add 7.5% Tax _____

TOTAL AMOUNT \$ _____

The American Radio Relay League
Helping Hams Get Started Since 1914

225 Main St, Newington, CT 06111
203-666-1541 • Fax 203-665-7531

PC ALSO AVAILABLE FROM YOUR LOCAL AMATEUR RADIO DEALER

Abbreviations Used For Intercepts

AM	Amplitude Modulation mode
BC	Broadcast
CW	Morse Code mode
EE	English
GG	German
ID	Identification/led/location
LSB	Lower Sideband mode
OM	Male operator
PP	Portuguese
SS	Spanish
tfc	Traffic
USB	Upper Sideband mode
w/	With
wx	Weather report/forecast
YL	Female operator
4F	4-figure coded groups (i.e. 5739)
5F	5-figure coded groups
5L	5-letter coded groups (i.e. IGRXJ)

NALF Sherman Fld, CA at 2246. (BV); Beacon SWU, Idaho Falls, ID at 1154. (SF)

353: Beacon LI, Little Rock, AR at 0354. (RH); Beacon LLX, Lyndonville, VT at 0940. 208m; Beacon MG, Montgomery, NY at 0743. 155m. (AH)

356: Beacon FR, Medford, OR at 1006; Beacon GMZ, Bowie, TX at 1059; Beacon OPZ, Lopez Island, WA at 1004; Beacon SA, Sacramento, CA at 1004. (SF)

362: Beacon HBK, Hinchinbrook, AK at 1029. (SF)

365: Beacon FT, Fort Worth, TX at 0907; Beacon MA, Mayo, YT, Canada at 0924. (SF)

368: Beacon L, Toronto, Ont., Canada at 0732. 443m. (AH)

371: Beacon ITU, Great Falls, MT at 1115. (SF)

372: Beacon ZPI, Paradise Island, Bahamas at 0644. 1188m. (AH)

CHEEK

The Ultimate Scanner!

The King of Scanners takes this step-by-step, richly illustrated, bench manual beyond everything ever published on scanner mods. Bill is a perfectionist who will help you convert your scanner into precisely what you've always wanted!

MAY 1995
244 pgs, large format, \$29.95

EMERGENCY RADIO!

Scanning News As It Happens
"Excellent..." Barry Goldwater
"Rates a 10!" Dispatch Magazine

Norm Schrein
214 pages, \$14.95

"A winner..." 911 Magazine
"Irresistible!" Bill Cheek

SCANNERS & Secret Frequencies

"Must reading" Electronics Now
"A giant undertaking, authoritative" Monitoring Times
"Absolutely the best..." Norm Schrein
"A high point!" RCMA

Henry Eisenson
320 pages, \$19.95

Underground Database

400 things that are sort of legal. SCARY!!

100 pages, large format, \$23.75

Television GRAY Market

Cable & satellite chips, descramblers, etc.
"Explores this shadowy fringe area in depth... good info" PopComm

Henry Eisenson
160 pages, \$23.75

INDEX Publishing Group, Inc.
3368 Governor Drive, Suite 273P
San Diego, CA 92122
619-281-2957 (editorial)

First book \$4 s/h, \$2 ea add'l
CA add 7.75% tax
MO/check via mail.
Order line 800-546-6707

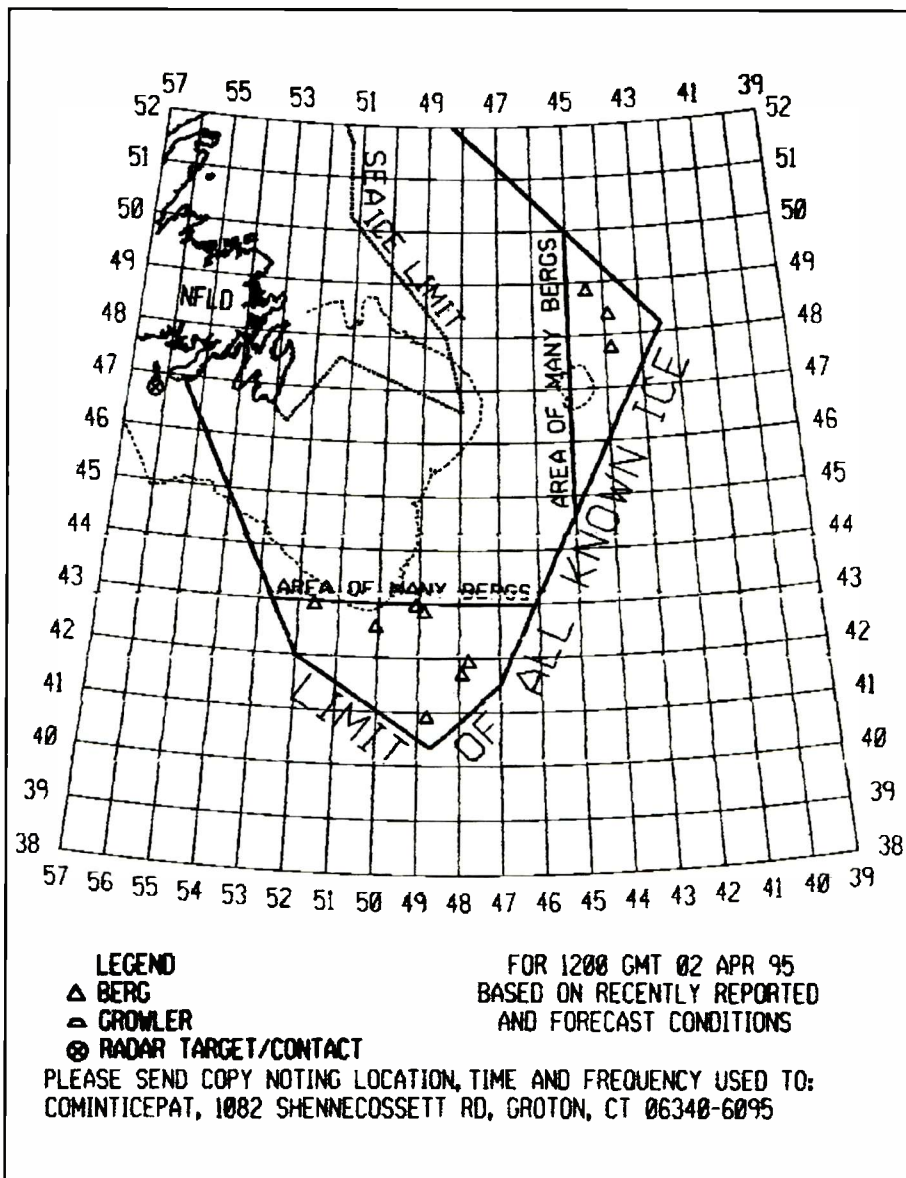

NIK transmitted this ice chart on the 6334 kHz frequency of NMF, Boston, MA.
Chart provided by Jacques d'Avignon, Ontario, Canada.

373: Beacon EP, Estevan Point, BC, Canada at 0925; Beacon MF, Medford, OR at 0837. (SF)

388: Beacon NXX, Willow Grove, PA at 1025. 222m, Beacon RNW, Chocowinity, NC at 0946. 521m. (AH)

392: Beacon EUR, Eureka, MT at 0810; Beacon PNA, Pinedale, WY at 0910. (SF)

396: Beacon APH, Bowling Green, VA at 0952. 399m; Beacon NEL, Lakehurst, NJ at 0856. 190m. (AH)

400: Beacon FN, Fort Collins, CO at 0927. (SF)
403: Beacon PO, Poughkeepsie, NY at 0930. 138m. (AH)

408: Beacon MW, Moses Lake, WA at 0919. (SF); Beacon HBD, Youngstown, OH at 0912. 480m; Beacon SFB, Sanford, FL at 1028. 1044m; Beacon SN, St. Catherine's, Ont., Canada at 0600. 412m. (AH)

413: Beacon OEG, Yuma Proving Grounds, AZ at 0857. (SF)

417: Beacon EOG, Greensboro, AL at 1017. 1091m. (AH)

423: Beacon DXE, Dexter, MO at 1028. 1051m; Beacon SIF, Reidsville, NC at 0924. 578m. (AH)

475: CW mode, u/i station. Approx 30 wpm. Hrd at 0840. (BV)

515: Beacon CL, Port Angeles, WA at 0850. (SF)

521: Beacon INE, Missoula, MT at 0813. (SF)

524: Beacon AJG, Mt. Carmel, IL at 0320; Beacon UOC, Iowa City, IA at 0327. (RH)

529.5: TIS in Chicago, IL area. Hrd at 0414. (AA)

530: Beacon F9, Chatham, NB, Canada at 1008. 476m. (AH)

1889: PIA, Swedish Navy at 18456 in RTTY, 50 baud, 5L grps to FAPKD. (AB)

2182: CFD2073, Mersey Venture in USB at 0420 wkg St. Anthony CG Radio. QSY 2538/2142 kHz. (JN); NMO, USCG Comm Sta Honolulu at 0816 in USB, wkg USCGC Sedge (WLB-402) re HF DL freq. (RB)

2261.5: Royal Navy London w/encrypted mssgs in RTTY, 75 baud, at 2010.

2295.5: MOI Bonn idling, ARQ-E 96 baud at 0128. (AB)

2500: WWV, time standard station at 0626. (SW)

2678: USCG Station Georgetown, SC, NMB7, at 0725 in USB wkg CG 41 footer #41396 w/status & posn re towing of a disabled vessel. (RB)

2841: R54X ??, u/i station. Sounded like "RED FIVE FOUR CROSSING. Bcsting air...warning to Western Norway," foll by aero wx reports and positions, Station hrd for three days in a row & then not hrd again. USB mode at 2020. (AB)

2892: GYA, Royal Navy London at 0140 in



N'Djemena CHAD Airadio

VERIFICATION OF RECEPTION

TO: EDWARD RAUSCH III

DATE: 17/06/94 FREQ: 8903 MODE: USB

XMTR: _____ ANTNA: _____

POWER: 5kW WATTS LOCATION: _____

REMARKS: *Station Secna THOMSON TRC 395*



Le Chef de Maintenance
SIGNED

Here is a PFC from Edward Rausch, NJ.

RTTY, 75 baud, w/availability mssgs. (AB)

3038: JULIA, Swedish Navy unit in RTTY, 50 baud, at 0025 w/5L grps. (AB)

3181: Scrambled speech in USB at 0220. (TS)

3206: U/i French station?? in ARQ-E 192 baud at 2220 in idle status. (AB)

3210: LYK, Klaipeda, Lithuania w/tfc list in CW at 2200. (AB)

3264: SLHFM "P" RMP, Navy Kaliningrad was clg RKZ in CW at 2302. Then into wx in Cyrillic. (AB)

3293: Numbers station. '539' for five mins + 5F grps. CW mode at 2245. (AB)

3313: HEP, Interpol Zurich, Switzerland in CW at 0031 w/VVV mkr. (AB)

3410: Scrambled speech in USB at 0604. (TS)

3451: 47. Irish military clg QVXV + routine mssgs in SITOR-A, 100 baud. Hrd at 2105. (AB)

3485: At 0110 CW station rptng NVKL NVKL NVKL/HXVH HXVH HXVH over and over. (SM); New York aviation wx, SSB at various times 0001-1200. (AZZ)

3550: YMA20. Ankara, Turkey Meteo w/Synops in RTTY, 50 baud, at 0103. (AB)

3915: In background of BBC World Service, CW station sending AZCS at 2100 and eventually into 5L grps at 2200. (SM)

4002: YRR2, Bucharest meteo w/Synops at 0018 in RTTY, 50 baud. (AB)

4016: CW cut # stn (1-0=ANDUWRIGMT) here at 0200 instead of usual freq of 4017 kHz. (TS)

4024: At 0400 WED a CW station sending NNN until 0405 when YL/EE said 'Group 25' and into 5F grps. (SM)

4116: VCLW, M/V Lucien Paquin, in USB at 0517 w/kg Halifax CG Radio. QSY 6212 due to QRM. (JN)

4119: U/i clg TRYH in CW at 2230. At 2240 same station now using callsign TO7R clg Z6GO. 5L grps. QJG QMO QYT1. (AB) Note: QJG refers to automatic relay. None of my refs list QMO or QYT1. (Ed.)

4177: WJGH, SS Stella Lykes in ARQ at 1202 w/Telex to INCHCAPE BALTIMORE. At 1332 w/AMVER. (JN)

4247: KPH, San Francisco, CA in SSB at 0900-0910 w/tfc list. (AZZ)

4465: Every first Monday of the month YL/Slavic at 2100 with 'Sem Pitoyorka Pitoyorka Chetta Nul Nul' (=755/00). Off at 2105. (SM)

4470: Wednesday at 2300 UTC YL/EE in AM w/3F. 0-9 for 10 min, then count 3F, then 3/2F grps. Also every day at 0100 same YL 3F rptd 3x, 1-0 for 10 min & then count 3F x2 & into 3/2F grps. (AZZ)

4539: Guardia Civil station clg EACV in ARQ 100 baud at 2140. Mssgs in Spanish. (AB)

4546: Scrambled speech in USB at 0245. (TS)

4570: HZN46, Jeddah Meteo w/Synops at 0014 in RTTY, 100 baud. (AB)

4572: OM/RR at 2020 with '585 585 585 1' til 2025 then '122 122 131 131' and into 5F grps. (SM)

4585: Civil Air Patrol callup in SSB at 0100. (AZZ)

4601.5: 12, Irish military w/OA, Dublin, at 1920 in SITOR-A, 100 baud. Sent 'PT54 HAS ZBO FOR YOU.' (AB)

4602: SNN299, MFA Warsaw at 1726 in POL-ARQ, 100 baud, with nx. Stn slightly off freq. (AB)

4745: LBG, Belgian military w/E8T in English at 1709 in USB. Rdo cks & encrypted RTTY 75bd. Each mssg was announced and confirmed by voice. After a while conditions became too lousy to work. One opr shouted very loud in Dutch, 'You are unreadable. Can't hear you! Go to Golf Kilo.' The other opr replied, 'If I understand you correctly, you got my message well.' (AB)

4800: White noise here at 0205. (TS)

5301: At 0400 WED YL/Czech OLX w/'961' rptd in background YL/GG w/1-0 count and '957.' At 0403 Czech YL into 5F grps and at 0410 after 10 dashes YL/GG into 3/2F grps. (SM)

5320: NZON, USCGC Point Estero (WPB82344) in USB at 0139 w/kg u/i stn (heavy QRM fm SS speaking YLs plus digital voice encryption). The SS sound like phone calls. (JN)

5397.8: RFFP, MOS Paris, France in ARQ M2 200/400 at 1859 in idle mode. (RH)

5400: NMR1, GANTSEC, USCG Greater Antilles Section, San Juan, PR at 0807 in USB clg V2Z then into 'Green' comms. (RB)

5438: Mossad bst in USB at 2130 w/mssg to ART. (AB)

5550: Zero Mike Lima Quebec Kilo in SSB at 0055 w/kg NY re wx & posn. (AZZ)

5640: Scrambled speech in USB at 0229. (TS)

5696: Rescue 2112 w/kg CAMSLANT out of Miami AirSta w/request for CAMSLANT to take radio guard. (USB at 0156.) (JN)

5800: White noise at 0300. (TS)

5834: At 1800 YL w/William Susan Peter foll by Queen Robert Union (no mssgs) at 1802. Also WSP has been hrd on 17502.5 kHz at 1200 in the USB of Radio Tunisia. (SM)

6200: WHAQ, PFC Eugene A. Obregon Chesapeake re RTTY guard. At 1849, NRCB, USCGC Eagle (WIX-327), a masted training barque, w/kg NMN re SITOR freq. At 1851, WST9756, R/V Seward Johnson, Harbor Branch Foundation research vsl, w/kg NMN w/BBXX wx obs. (RB)

6273: M/v Bulk Explorer in ARQ at 1103 w/telex tlc concerning arrival at Cristobal and plans for transit of Panama Canal. (JN)

6326.5: KMI, Dixon, CA at 0800 in SITOR 170/100 w/wx. (JC)

6415: WLO, Mobile, AL in LSB at 2003. Sent traffic list & at 2007 began calling CQ. (SW)

6420: CCS, Santiago, Chile at 0650 w/encrypted wx in baudot 170/100. (JC)

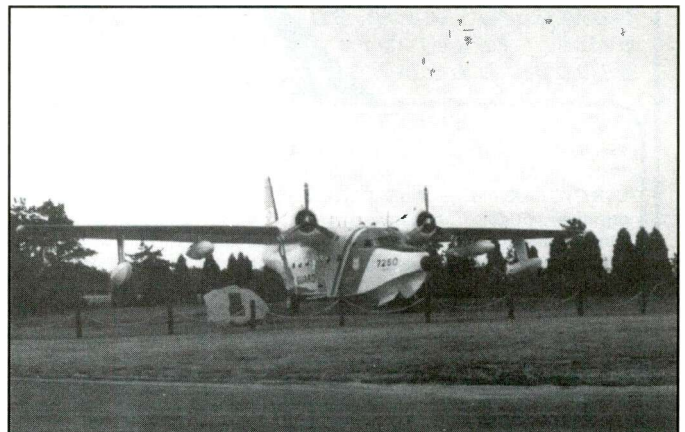
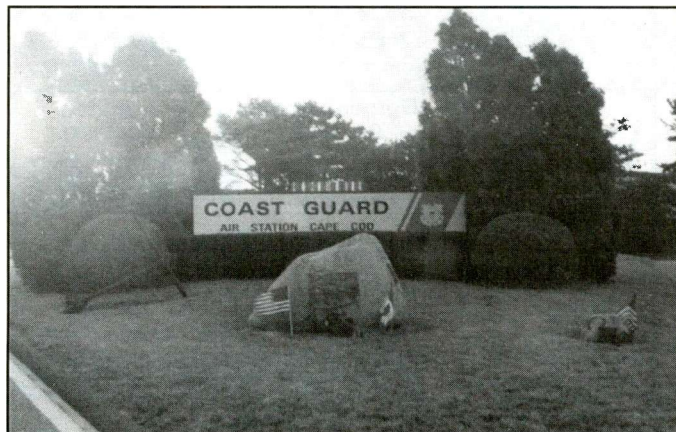

a.) These photos were taken at the Cape Cod CGAS by Kevin D. Tubbs, VT b.) Older type CG SAR aircraft.



Sikorsky HH-60J Jayhawk. Medium range SAR. Has Bendix/King RDR-1300 search radar mounted in nose. Has a Spectrolab Nitesun searchlight. For extended range operations there are three external fuel tanks. Two 120-gallon tanks on the portside and one 80-gallon tank on the starboard side.



USCG AIRCRAFT "RESCUE 6009"

To: Amateur Radio AA4JN

This confirms reception of USCG radio transmissions

Date: 15 Jun 93 Time: 1333 Z Mode: USB

Approx. Location: Yorktown, VA

Unit/"Homeplate": USCG Air Station Elizabeth City, NC

Freq: 5696 kHz A/C Type: Sikorsky HH-60J "Jayhawk"

Remarks: SAR Demo for members of the Albanian Navy.

Jim Navary
signature/title

This PFC from Jim Navary, VA reflected a unique logging. The transmission pertained to a search and rescue demonstration held by the USCG for Albanian naval personnel.

6493: VAI, Canadian CG, Vancouver at 0715 in CW w/wx & nav wrngs. (JC)

6501: USCG CAMSLANT, Chesapeake, VA in SSB at 1010. OM/EE w/sea wx. Signed off w/"experiencing technical difficulties with transmitter" at 1025. (AZZ)

6509.5: British Royal Navy Coastal Control w/2-tone channel mkr at 1215. (AB)

6516: NOP, USCG Air Sta Brooklyn, "Brooklyn Air" at 1932 in USB wkg u/i a/c J1S. (RB)

6645: Every Monday at 1900 the Jean-Michael Jorre track "Magnetic Fields Part 1" is played for 20 secs foll by YL/EE into 5F grps. New station. The same piece of music is used in the Voice of Russia's Arts Program. (SM)

6676: Sydney VOLMET in SSB at 0930 w/automated aviation wx. (AZZ)

6797: AM carrier in at 0250 w/distorted Radio Havana programming. At 0300 distorted YL/SS w/5F grps. (TS)

6800: OTH Radar at 0333. (TS)

6900: Sweep jammer at 0345. (TS)

6964.8: Two-way comms in SS, poss Spanish bootleggers? (AA)

6983: Nbrs stn in SS at 0209 w/5F grps. (AA)

7185: WA3NAN at 0000 in LSB w/relay of shuttle xmsns. (AA)

7535: SESEF Norfolk: NAYH, USS Harlan County (LAST-1196) at 1355; NADQ, USS Grasp (ARS-51) at 1740. (JN); NHOV, USS Saipan (LHA-2) at

1557 clg SESEF no joy; NRKX, USS La Moure County (LST-1194) at 1736, NCGB, USS Portland (LSD-37) at 1809; u/i stn "Newport" prob Newport News shipyard at 1813. Primary mode was USB. Various equip tested. (RB)

7711: OTH radar at 0617. (TS)

7783.3: KAWN, USAF Carswell, TX w/wx in baudot 75/350 at 0350. (JC)

7920: CW cut # stn (1-0=ANDUWRIGMT) at 0405. (TS)

8045: Scrambled speech at 0414. (TS)

8117: BMB, Taipei meteo in CW at 1004 w/Marine wx forecast for next 24 hrs. (JN); OM/RR at 2120 w/191 191 191 1 then at 2125 8391 72 8391 72 and into 5F grps. Ended w/000 000. (SM)

AR3030 HF Receiver



IBS☆☆☆

AOR offers leading edge technology in receiver design with the introduction of the AR3030. Unbelievable design & price tag...nothing has been spared! Compare AR3030 features with other receivers costing over \$1000...The AR3030 is the Winner!

SPECIFICATIONS

Frequency: 30-kHz-30MHz plus optional internal VHF converter 108-174MHz • Memories: 100 programmable w/ scan • Modes: AM, LSB, USB, CW, FAX, FMN • Tuning Accuracy: 10Hz • Image & Spurious rejection: >70dB • Dynamic Range: >100dB @ 25kHz spacing
Antenna inputs: (1) Coax 50Ω unbal. (2) 450Ω bal. (3) Hi-Z for whip
Audio output: External speaker, FAX, Record • IF Output: 455kHz
Computer: RS-232C • Power: 12VDC -800mA (max. audio); 8AA Nicad or Alk (not incl.) • Size: 10"W x 3.5"H x 9.5"D: 4.8 lbs.

Superior Performance & Unsurpassed Value!

Electronic Distributors Corp.

325 Mill St. Vienna, VA. 22180
Phone: (703)-938-8105 • FAX: (703)-938-4525
Available at your favorite dealer.



Call Toll Free

1-800-666-0908

Pricing and Orders Only

YAESU FRG-100

Worldwide desktop communications receiver
Covers 50kHz - 30MHz
AM/SSB/CW (FM optional)

- 50 memory channels
- Built in selectable filters 2.4, 4, 6kHz

- WRTH "Best Communications Receiver"
- Many, many more features

► CALL FOR OUR LOW DISCOUNT PRICING ◀

Yacht Boy 400



GRUNDIG

World Receivers
The Ultimate In Digital Technology

Satellit 700



AOR AR8000



AOR AR2700



NEW: AR8000 & Scout 40 reaction tuning MOD + cable pkg \$1044.00
AR2700 and Scout 40 reaction tuning MOD + cable pkg \$829.00
Both Fully Warranted

Optoelectronics Scout 40 ver. 3.1

Call for all Optoelectronics \$

Drake R8A and SW8



Call for discount prices on Drake, Sony, Grundig

Uniden BC9000XLT



\$379.95 delivered UPS Ground (48 states)

Call for all Uniden/Bearcat

Conn Sales 203-667-9479

Infor. & Tech Help 203-666-6227



LENTINI COMMUNICATIONS, INC.

21 Garfield St. Newington, CT 06111

C.O.D.'s OK - SAME DAY SHIPPING

HOURS: M-F 10am - 6pm SAT 10am-4pm



CIRCLE 61 ON READER SERVICE CARD

CIRCLE 65 ON READER SERVICE CARD

DELTA AIR LINES, INC.

GENERAL OFFICES
HARTZ FELD ATLANTA INTERNATIONAL AIRPORT
ATLANTA GEORGIA 30320-0001 U.S.A.

February 26, 1995

Mr. Mark Heywood

Canada T5Y 1J3

Dear Mark:

Thank you for your recent QSL report from when you monitored our flight 108 (DL108). That flight operates our Lockheed L-1011 TriStar aircraft. It uses a Collins 100 watt transmitter on the HF band.

Delta is a world-wide airline operating over 550 aircraft. Enclosed is our QSL confirmation card picturing our L-1011 aircraft.

Thank you for taking the time to send us your QSL and I hope the confirmation will help in your collection.

Sincerely,

Ed Ferguson
Edward W. Ferguson, N4YTR
Communications Watch Supervisor
In-Flight Radio, Dept 180
Delta Air Lines, Inc.
1030 Delta Blvd.
Atlanta, GA 30320

Mark Heywood, Alberta, Canada received this letter as his reception confirmation.

8122: VHI, Royal Australian Navy, Darwin, "Darwin Control" at 1240 wkg several HMAS ships. Hrd were: VLRH, HMAS Bendigo (P-211) at 1204 w/immediate mssg; VLRO, HMAS Bunbury (P-217) at 1213; VLRB, HMAS Wollongon (P-206) at 1120; VLRV, HMAS Paluma (A-01) at 1231 wkg same, Survey ship last known to be doing work along Great Barrier Reef. All in USB mode. (RB)

8165: 5YD, Nairobi, Kenya in RTTY 50/500 at 0415 w/RV's & CQ tape. (TS)

8335.5: DRAO, FGS Lubeck (F-214), German Navy type-12 frigate, at 2319 in USB wkg DHJ59, Wilhelmshaven Naval w/QRU after RTTY tfc. (RB)

8348.5: ELED9, M/V Eijin in CW at 0514 wkg OBC3, Callao Naval, Peru w/mssgs. (JN)

8385: C6JM4, M/V Mimoza, at 0801 in SITOR-

A w/tlx via St. Lys rdo, Paris, vsl bound Odessa w/3267.3 MY of bananas. (RB)

8396: VRUB9, M/V Great Lake in ARQ at 0657 w/telex to WORLDER SHPG HKG; dropped link in mid-mssg. (JN)

8416.5: NMO, Honolulu, HI in FEC at 0430 w/wx. (TS)

8638: VNG, Australia in AM at 1322 w/time sigs. (TS)

8686: JCT, Choshi, Japan at 0637 in CW. (JC)

8967: Foxtrot Tango, USN Link-11 coordination net at 0104 in USB wkg GULF re troubleshooting problem. Will advise when back up. (RB)

9014: SNAKE 1 wkg SNAKE 7 in USB at 2250. (JN)

9072.5: TLO50, ASECNA Bangui at 2236 in ARQ-M2 w/idling in 96/580; at 2301 w/FEFF metar tfc on circuit "OFA." (RB)

9094: OTH radar at 0505, later on 9209 kHz. (TS)

9122.5: Corps of Engineers net, WUG, net control. USB at 1501. Stns hrd include WUI5, WUA, WUE4, WUH5, WGY936, WUB2, WUB5, WUJF, WUI6, WUE5, WUJ2, WUE6, WUE. Net meets on Fridays at 1500. (thanks to Jim Pogue for the tip.) (JN)

10041.8: U/i, poss Egyptian Diplo tfc in AA. SITOR-A at 1236. (RH)

10051: Gander in SSB at 2130 w/wx for St. Johns, foll at 2132 w/NY Terminal forecast. Signed off as New York Radio Oceanic Lima 8. (AZZ)

10053: NY rdo w/aviation wx in LSB at 1812. (SW)

10364.7: RFTJF, French Forces, Port Bouet, at 2025 in ARQ-E idling in 48/870 at 2118 C de V on circuit JNF. (RB)

10940: At 1130 ten tones foll by YL/EE w/4298/6370/9490/15641 kHz. Off at 1140. (SM)

10960.4: 3MA28, Taipei, CNA nx/EE at 0853 in RTTY 50/823. (RH)

10982.2: BAP40, XNA Beijing, nx/EE at 0858 in RTTY 75/1000. Note baud!, unlisted. (RH)

11090: Honolulu Meteo, KVM70, FAX 120/576 at 0531. (JC)

11133.1: BZG41, XNA Beijing, nx/FF at 1905 in RTTY 50/379. (RH)

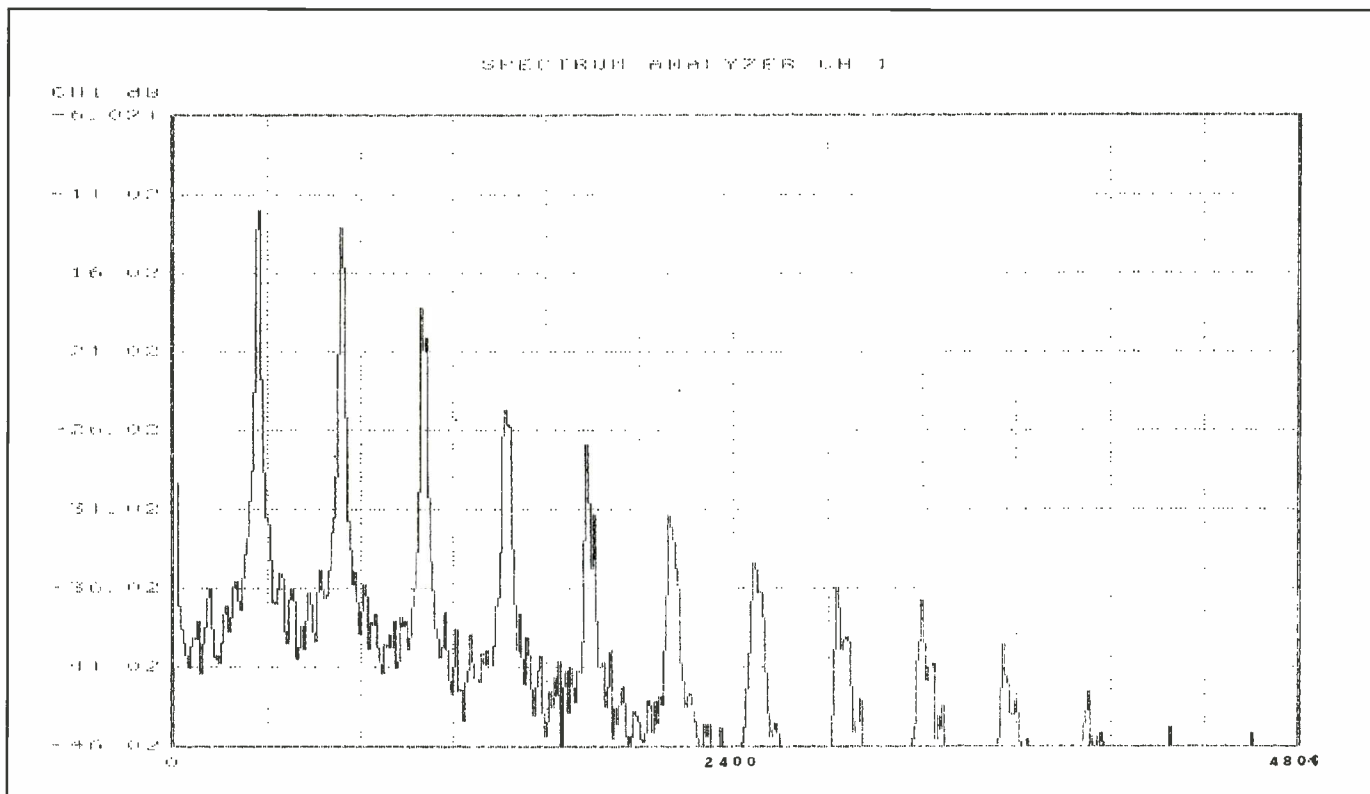

Signal analysis chart of buzzing signal heard on 7340 kHz in AM mode. This is possibly a CCIR type R.38 VFT with 360 Hz channel spacing. Chart prepared by Kevin D. Tubbs, VT.

COMMODORE® USERS

SWL

SWL: A receive only cartridge for CW, RTTY (Baudot & ASCII) for use with Commodore 64/128. Operating program in ROM.....~~\$69.95~~

NOW \$49.95

ART-1: A complete interface system for send and receive on CW, RTTY (Baudot & ASCII) and AMTOR, for use with the Commodore 64/128 computer. Operating program on disk included...~~\$199.00~~

ART-1

NOW \$169.95

AIR-1

AIR-1: A complete interface system for send and receive on CW, RTTY (Baudot & ASCII) and AMTOR, for use with Commodore VIC-20. Operating program in ROM.....\$99.95

MORSE COACH: A complete teaching and testing program for learning the Morse code in a cartridge. For C64 or C128.....\$49.95
VEC SPECIAL.....\$39.95

MORSE COACH

G AND G ELECTRONICS
OF MARYLAND

8524 DAKOTA DRIVE
GAITHERSBURG, MD 20877
(301) 258-7373



CIRCLE 164 ON READER SERVICE CARD



GLOBE WIRELESS

Coast Radio Station Network

- KFS Palo Alto Radio, California
- WNU Slidell Radio, Louisiana
- VCT Newfoundland, Canada
- KEJ Kahalelani, Hawaii
- ZLA Awanui, New Zealand
- _____

Headquarters: One Meyn Road, Half Moon Bay, CA 94019 USA

To

This confirms your reception of the Globe Wireless HF coast radio station as marked on the front of this card

at UTC, 19.....

using CW SITOR mode

Thank you for your report!

Signed
Globe Wireless

Send Globe Wireless your reception reports and you will receive this handsome QSL card suitable for display in your radio shack.

11175: Army 23373 in USB at 1653 clg MacDill, then Andrews, no joy. At 1700, wkg Andrews w/pp. Was enroute Orlando; AAFA, u/i U.S. Army vessel. ISB at 0152 wkg Hickam. Wanted opr at McClellan AFB. Departed Haiti, off Cuban coast en-route to Florida. (JN)

11270: 'Russian Man' numbers station in AM at 0820. Announces 615, 85520, 81590, 00000. (AB)

11706: HZXR, M/V Al Zahran in CW at 1413 w/telex to HARDIN BROTHERS, AVONMOUTH. (JN)

12184: KAWN, USAF in RTTY 50/170 at 2008 w/wx. (SW)

12341: U/i racing yacht wkg Australia at 0044 & gives position report, progress, wx, ETA & also reports they lost "light stand." (TF)

12477.5: BRAU, M/V Hua Rong Shan in ARQ at 1455 w/posn report & ETA Pascagoula. (JN)

12485.5: JNNU, M/V Nippon Maru. Japanese passenger vsl, at 1944 in SITOR-A w/AMVER/PR. (RB)

12574: EKGS, TK Kapitan Telov at 1918 in 50/170 w/3 crew TG's to Murmansk Radio. Using hull#/ID MA-0060. (RB)

12579: NMF, CommSta Boston, MA in FEC at 1635 w/NAVAREA IV warnings. (TS)

12613: XSQ, Guangzhou Radio, China in CW at 1843 w/mkr. (AB)

12829: XFM, Manzanillo, Mexico in CW clg CW QRU. USB at 1920. (SW)

12875: VCS, Halifax CG radio, Canada in LSB at 1833 calling CQ, QRU, w/VVW mkr. (SW)

13043: PJC, Netherlands Antilles at 1836 clg CQ QRU. (SW)

13356.2: EGRR, Bracknell Meteo at 1756 in RTTY 75/386 w/coded wx. (RH)

1414.5: Navy MARS. NNNOMEG, u/i USMC MARS sta at 1624 wkg NNNONIG w/QSY to 14818.5 for pp tfc. NNNOCNP, USS Bainbridge (CGN-25) at 1825 wkg NNNOADV in Denver, CO w/QSY 14470 pp tfc. NNNOCOH, USS Cape Cod (AD-43) at 2319 wkg NNNONUW, Naval Air Sta Whidbey Island, WA w/QSY to 14467 for pp tfc. All in USB mode. (RB)

14750: YL rptng Mike India Whisky 2 at 1415. Also on 12747 kHz. (SM)

14890: 'Russian Man' numbers station in AM at 0800. Announced 615, 86060, 84690. (AB)

15862: SAM, MFA Stockholm (UD/VALDE-MAR) at 1220 in SWED-QRQ 100/385L w/tfc/SWED to Amb "Kairo." (RH)

15980: At 1200 YL rptng Echo Zulu India. Then at 1203 Group 117 and into 5L grps. (SM)

16027.6: NPN, USN Apra Harbour, Guam at 1243 w/FAX 120/576, VG chart. (RH)

16038.3: U/i at 1239 in SITOR-A w/tfc in FF, "SEND VALISE SATELLITE PHONE QUICKLY!!" (RH)

1995

WRTH Equipment Buyer's Guide



Your #1 source for advice on what to buy in equipment and accessories for SWL'ing.

Objective reviews and equipment evaluations make this new volume a must for all SWL's. WRTHBG95 ©1995 **\$24.95**

Shipping \$4 USmail \$7 Foreign

Free 24 page catalog jam-packed with books for SWL's CB'ers, scanner buffs and Radio Amateurs. Send for your free copy today!

Radio Bookstore

PO Box 209
Rindge, NH 03461

(800) 457-7373



CIRCLE 75 ON READER SERVICE CARD

- ⇒ Date and Time (UTC) of your reception
- ⇒ Call Sign (QRA) of the Globe Wireless network station heard
- ⇒ Either the actual frequency (QRG), or ITU channel number
- ⇒ Mode of transmission heard (SITQR, CW, etc.)
- ⇒ Signal strength (QSA) and quality
- ⇒ Any interference (QRM) heard on frequency, or on adjacent channels
- ⇒ Did you hear traffic or idle signals? If traffic, whom were we working?
- ⇒ Model number of receiver and type of antenna used
- ⇒ Location (QTH) of your receiving station
- ⇒ Any other comments

Include a complete mailing address with all reports so that we may send your QSL card by return post. Ships are requested to include either the address of the vessel's home port or the Radio Officer's personal address. Please send your reception reports for all Globe Wireless stations to

GLOBE WIRELESS
Attn.: Engineering Department
One Meyn Road
Half Moon Bay, CA 94019 USA

To be of maximum value to the Globe Wireless Engineering staff, reception reports should contain the above information.

16261.9: RFTJD, French Forces Libreville, Gabon at 1010 in ARQ E3 192/359 w/144 5L grps to RFFXI/RFGW (Paris). (RH)

16355.8: OMZ, MFA Prague at 1143 in RTTY 100/425 w/nx in Czech. (RH)

16715: PHIU, TR Schoener, at 1722 in SITQR-A w/tlx giving posn: vsl bound Valparaiso to Wilmington, DE. (RB)

16788.5: URUG, Sov ship Mikola Bajan at 1201 in RTTY 50/170 w/Odessa. (RH)

16804: EMAJ, BMRT Domodedovo, at 1711 in RTTY 50/170 w/RY's UDK-2, Murmansk Radio & into crew TG's using hull # ID MB-0361. (RB)

16841.2: RTTY best 75/500 to JMS at 2230

w/5L grps. Russian MFA. After msg sent TTTTT instead of usual QRU QRU SK SK. (TS)

17499: At 1200 alternative Lincolnshire Poacher YL/EE with 'Cherry Picker' tune and '65037.' At 1210 into 5F grps. Also hrd at 1300 on 14469 kHz. (SM)

18041: TCY4, Ankara, Turkey at 1045 in RTTY 50/812 w/nx in GG/FF/EE. (RH)

18189.3: CLP1, MFA Havana, Cuba at 1924 in RTTY 50/425 w/RY's & "FELIX DIAZ VOYA BAJARTE WHISKEY PAGAME EN CHEQUE 1234567890 (CLP-1)" (RB) New test tape for Cubans?? (Ed.)

18349.3: CLP1, MFA Havana, Cuba at 1930 in RTTY 50/425 w/RY's & into EmbaCuba Circular t/c

for Benin, Bissau, Guyana, Uganda, Conakry, Ghana, Tanzania, Zambia. T/c in 5F grps. (RB)

18414.9: 8BY, u/i in CW at 1746 w/VVV 8BY 297/776/017/626/697. Clues anyone? (RH) Some European monitors believe 8BY may be located in Middle East region. (Ed.)

18762.2: MFA Bucharest at 1117 in ROU0ARQ 164/368. Unable decode. (RH)

19357.5: MFA Abuja, Nigeria at 1131 in FEC-A 96/618 w/t/c in EE to all stations. 1st time I have hrd this. (RH)

20113.4: FJY2, French Forces Port aux Francais, Kerguelen Islands (SE of tip of S. Africa) at 0905 in ARQ E3 96/393 w/t/c in FF. "FM DISTAM TO IFRTB BREST." (RH)

Note: DISTAM apparently refers to Amsterdam Island District. Mssg must have been sent from there to Port aux Francais for relay. (Ed.)

20138.2: Suspected Russian MFA bcst to YBU at 2200 in RTTY 75/500 w/5L grps. (TS)

21018: OTH radar at 2024. (TS)

21807.3: YOY28, ROMPRESS, Bucharest at 0811 in RTTY 50/400. (RH)

22374: UHXG, Sov ship "Proliv Longa" at 0948 in RTTY 50/170 w/Sevastopol. (RH)

22460.9: FUJ, Noumea Naval, New Caledonia at 2134 in RTTY 75/170 w/RY's. (JC)

Our contributors this month were: AAZ—Anonymous, IL; AA—Andrew Ashbaugh, IL; AB—Ary Boender, Netherlands; RB—Richard Baker, OH; JC—James Callaway, Jr., NV; PC—Perry Crabill, Jr., VA; SF—Stan Forsman, CA; TF—Trevor Fletcher, Alberta, Canada; AH—Al Hemmalin, RI; RH—Robert Hall, South Africa; SM—Simon Mason, England; JN—Jim Navary, VA; TS—Tom Sevart, KS; BV—Bjorn Vaage, CA; SW—Sue Wilden, IN.

GRUNDIG Yacht Boy 400

Now the award winning YB-400 at a very special price!

The Yacht Boy 400 is praised in the *1994 Passport To World Band Radio* as "Best performance for price/size category ... right up there with the very best among world band radios." *Passport'95* rates the YB-400 as "The compact model most preferred by our panelist in Eastern North America and Europe for listening to major world band stations." This radio has it all.

- ◆ AM/FM/LW and continuous shortwave coverage from 1.6 - 30 MHz.
- ◆ Super-accurate digital display (to 1 kHz on shortwave).
- ◆ Keypad entry for instantaneous tuning.
- ◆ Wide and narrow selectivity separates stations.
- ◆ 40 Presets with memory or band scanning.
- ◆ Excellent Single Side Band reception with fine tuning knob.
- ◆ The dual digital clock displays even when the radio is on.
- ◆ External jacks for: stereo earphone, 9 VDC or antenna input.
- ◆ Switches for Local/DX, S.S.B., Tone, and UP-DOWN tuning.
- ◆ Supplied with: six AA cells, case, stereo earplugs, wind-up antenna, *Owner's Manual* and *Grundig Shortwave Guide*.

■ **Yacht Boy 400 Factory Reconditioned.** Excellent like-new condition, same 1 yr. warranty, accessories, manuals etc.

#1704 \$149.95 (+\$6 UPS)

■ **Yacht Boy 400 New** #0040 \$199.95 (+\$6 UPS)

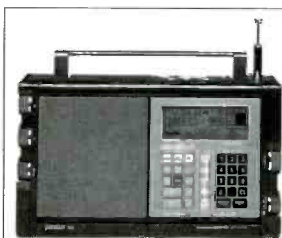

For the discriminating listener!

Perhaps the most sophisticated portable available, the **Grundig Satellite 700** offers every high-technology feature along with exceptional audio fidelity and the most advanced memory system of any radio. Are you ready for the best?

\$449.95 (+10 UPS)



Showroom Hours
 Mon.-Fri. 10:00 - 5:30
 Saturday 10:00 - 3:00

universal radio inc.

Universal Radio, Inc.
6830 Americana Pkwy.
Reynoldsburg, OH 43068

- 800 431-3939 Orders & Prices
- 614 866-4267 Information
- 614 866-2339 Fax Line

FREE CATALOG

Our huge, new **100 page catalog** has everything for the listener, ham or scanner enthusiast! Equipment, accessories, antennas, books and much more. With prices!

Thoughtwaves (from page 5)

ers' homes in search of my first CB rig, which was a Lafayette Comstat 19, and later a Lafayette Comstat 23 Mark VI. Then the scanners came about and I was uniquely interested in all there was to hear on these VHF-UHF receivers. After I tired of buying boxloads of crystals, I tried the new programmable models. And somewhere along the way I discovered things like TV DXing and ham radio and GMRS and...well, it's a never ending struggle for the checkbook!

When the bug got really bad, I discovered late in junior high school something called S9 magazine. Its editor was Tom Kneitel and I enjoyed reading the CB reports, the scanner information from Rick Maslau and especially Tom's writing. When the magazine stopped coming to my mailbox, I was at a loss for overall hobby radio information. I suddenly was more into ham radio than CB radio at the time, and then it happened.

I was at Newark International Airport in the fall of 1982 when I stopped at a news-

stand to browse the magazines. On a shelf in the back was this new magazine called *Popular Communications*. I was quite surprised and delighted to see that it was the "1st issue." You hate to think that something like this was out there and you never had any idea! But, I liked what I saw and quickly subscribed to the magazine. I didn't waste any time cutting a check for \$12 and firing it off to Hicksville.

I also decided to try something unusual. I wrote to the editor, this familiar chap from S9 named Tom Kneitel, and asked him whether he had a need for any articles. I had never really done any magazine writing before, although I had been a news journalist for some years. A few months down the road, the scanning column needed a new writer and Tom asked whether I'd be interested in writing it on a monthly basis. That was on Jan. 18, 1983. The rest is history, as my first column appeared in the June 1983 issue of *POP'COMM*. I've been writing the column ever since, as well as some features along the way.

Without that opportunity Tom presented to me, I wouldn't be here writing *this* column today. Tom has put together one heck of a magazine over the years. I have been not only a writer for this publication, I also have been a reader. The interaction that Tom and I have had over the years has been an education for me. While I never would have imagined myself in this new role a few years ago, Tom has been a mentor for me. I have learned not only from his writings, but also his friendship as an associate. He's always told it as it is, and that's what has made him such a great editor in the hobby radio market. It would be hard to imagine *POP'COMM* without Tom, and I am pleased he will continue writing for us and have an active part in the magazine.

It's time to move forward. The magazine will continue publishing as it already has for more than 150 issues. Don't look for wholesale changes, jerky moves, or things that go bump in the night. Do look for more good writing, more good columns and more good information, as you have come to expect from *POP'COMM*.

In his editorial in that first issue back in 1982, Tom said: "...we are here to serve your needs and interests. That is to say, we are interested in you and we need you."

I agree. We still need you. I welcome your comments about the magazine, whether they are good or bad. I read every piece of correspondence sent to me and I welcome your input, much like our various columnists like to hear from you. You can write to me at: Chuck Gysi, N2DUP, Popular Communications, 76 N. Broadway, Hicksville, N.Y. 11801-2953; you can fax me at (516) 681-2926; or you can send me e-mail via the Internet at POPCOMM@aol.com. Keep reading. And we'll keep writing. Especially the things you like to read about.

73, Chuck

You Should Know (from page 42)

As the tests were being broadcast in Las Vegas, some engineers with digital receiving equipment in the eastern United States were able to receive the AM nighttime broadcast. They reported clear, static-free, CD-quality reception! This was possible because the digital radio receiver is not really a radio as we know and understand it today. The digital receiver reconstructs the sounds from the "1"s and "0"s of the digital signal. The static and fading are not reconstructed as sound as they are not part of the digital transmission. You hear only what is transmitted and none of the other noise that is on the band.

Digital radio already is here for two-

way communications. It is just around the corner for AM and FM broadcasting. Digital TV and digital satellite radio are coming soon. The possibilities are endless as this technology projects us all into the 21st century! You soon will find megawatt radio signals offering you single station listening on your car radio as you drive from coast to coast. Why drive? Why not have a transporter like the one from the Starship Enterprise just transport you digitally from here to there, while you are listening to a digital radio song of your choice! I can't wait to see what is coming next, as the door has just been cracked! ■

**NEW
from CQ!**

CQ Has the Perfect Solution for the New Ham! The 1995 CQ Beginner's Guide to Amateur Radio

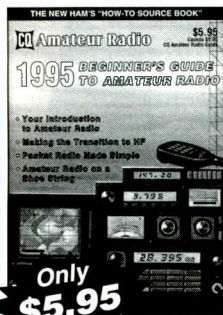

Most new hams have lots of questions. CQ has the answers. The **1995 CQ Beginner's Guide to Amateur Radio** is absolutely the best source of information for amateur radio equipment and practical operating advice. It's a CQ tradition and available today! But that's not all—veteran hams find our guides to be invaluable too! Filled with practical information from some of our hobby's most seasoned hams you'll find this edition to be our best yet. Here's just a sample of the articles you'll find:

- Your Introduction to Amateur Radio...VHF/UHF, Joe Lynch, N6CL
- Making the Transition to HF, John Dorr, K1AR
- Packet Radio Made Simple, "Buck" Rogers, K4ABT
- Amateur Radio on a Shoe String, Rich Moseson, NW2L
- Software for Amateur Radio, Ed Kalin, K1RT

And There's Much, Much More!!

In addition to incredible articles, you'll find page after page of equipment listings complete with product specs, prices, and other valuable information. And, who can't use our world-renowned Dealer and Manufacturer listings? Discover exactly where to reach the companies and distributors that serve the amateur marketplace—all in an easy-to-use index of phone numbers and addresses.

You'll want to keep this resource handy for your day-to-day operation.

Don't delay, be sure to order your copy

of the **1995 CQ Beginner's Guide to Amateur Radio** right away!

Mastercard, VISA, American Express, Discover accepted. Send card number with expiration date with order.

CQ Communications, Inc., 76 North Broadway, Hicksville, NY 11801. FAX 516-681-2926

Also available through your local dealer!

For Fastest Service, Order Toll Free
(800) 853-9797

COMMUNICATIONS SHOP

Advertising Rates: Non-commercial ads are 30 cents per word, including abbreviations and addresses; minimum charge \$6.00 per issue. Ads from firms offering commercial products or services are \$1.00 per word; minimum charge \$20.00 per issue. Boldface words are \$1.20 each (specify which words). Leading key words set in all caps at no additional charge. All ads must be prepaid in full at time of insertion; a 5% discount is offered for prepaid 6 time insertions. All ads must be typewritten double spaced.

Approval: All ad copy is subject to Publisher's approval and may be modified to eliminate references to equipment and practices which are either illegal or otherwise not within the spirit or coverage scope of the magazine.

Closing Date: The 10th day in the third month preceding date of publication. Because the advertisers and equipment contained in Communications Shop have not been investigated, the Publisher of Popular Communications cannot vouch for the merchandise listed therein. Direct all correspondence and ad copy to: PC Communications Shop, 76 N. Broadway, Hicksville, NY 11801.

Please take note: As of May 1, 1995, we are no longer accepting free subscriber ads.

CB RADIO OWNERS AND DEALERS. A new line of accessory circuits is now available. Breaker Beeper, Receiver Pre-Amplifier, Roger Beeper, many more—some never before available! Send an S.A.S.E. for a free catalogue to 6810 7th Street, N.E., Tacoma, WA 98422.

TRADE OR SELL Realistic HTX-202 with optional speaker mike, \$200. Realistic PRO-37 200 channel scanner, \$200. Have manuals. Will trade both for ICOM R-1. Call Steve, (914) 774-8891.

TOMCAT'S BIG CB HANDBOOK, by Tom Kneitel. 221 large pages, fully illustrated. Complete guide to worldwide AM, SSB, Freeband, 27 MHz operations. Everything they never told you (legal & otherwise) from world's leading CB authority. Only \$15.95 plus \$5.00 s/h (Canada \$6.00) from CRB Research Books, Inc., PO Box 56, Commack, NY 11725. (NYS residents add \$1.78 sales tax).

WANTED: RADIO NEWS MAGAZINE, February 1944 (Special Signal Corps Issue). Pay \$25.00- \$50.00 depending on condition, & Military Radio Manuals (all years). **GENE, KD4YIZ**, 1-800-619-0900, MMI, Box 720024, Atlanta, GA 30358-2024.

WORLD'S MOST UNUSUAL Communications Books! A large selection of outstanding titles covering scanners, "confidential" frequency registries, bugging, wire tapping, electronic surveillance, covert communications, computers, espionage, monitoring, and more! New titles being added constantly! Ask for our big FREE catalog. CRB Research, BOX 56-PC, Commack, NY 11725.

NEW AWARDS PROGRAM! For SWL's, DX'ers, Scanner Buffs! Self-addressed stamped envelope brings details! ISWAC, Box 66, Hanover, MI 49241.

HOW TO BUY A USED SHORTWAVE RECEIVER—\$6 ppd. Complete catalog of Patriot/Right Wing books - \$1. Bohica Concepts, POB 546-PC, Randle, Washington 98377.

LOOKING FOR crystals for Drake 2B receiver. Also need information on restoring cellular capacity to Realistic Pro-46 scanner. Sue Wilden, 2204 6th Street, Columbus, IN 47201.

WANTED: USED OPTOELECTRONICS APS104 PRESELECTOR. FOR SALE: OPTOELECTRONICS CF800 8355 MHz Filter/Amp. Brent Gabrielsen, 1177 East Tonto, Apache Junction, AZ 85219. (612) 969-8663.

SHORTWAVE LISTENER looking for RTTY, FAX, etc., enthusiasts in Miami, FL area. I have equipment, but can use more know-how. Maybe start a club? Call Dan, (305) 226-3987.

COMMODORE 64 HAM PROGRAMS—8 disk sides—over 200 Ham programs—\$16.95. 32¢ stamp gets unusual software catalog of Utilities, Games and British disks. Home-Spun Software, Box 1064-PC, Estero, FL 33928.

MINI SONY Surveillance TV System. Swedish/German light meters, temperature chart recorder, professional sound meter. Shack applications. Pictures/info; \$1/LSASE to: R. Summers, 6804 Rockforest Drive, Louisville, KY 40219.

TUNE In On Telephone Calls. Revised and Updated Edition! Tom Kneitel's controversial 160-page book. Everything you need to know to effectively use a scanner and communications receiver to eavesdrop on private telephone calls from homes, offices, cars, ships, aircraft, trains. Explanatory text, photos, extensive listings section covers USA/Canada on HF, VHF, UHF, and above; thousands of locations, frequency assignments. Explains equipment, best techniques, laws regarding monitoring cellular, cordless, ship/shore, high seas, Air Force 1, airliners, 1-way paging, more. Only \$14.95 plus \$5.00 s/h (Canada \$6.00) from CRB Research, PO Box 56, Commack, NY 11725. NY residents add \$1.70 sales tax. Dealer inquiries invited. Visa/MC OK. Tel: 1-800-656-0056.

RADIO SHACK SCANNERS - Lowest prices all catalog items. 1000-channel PRO-2035, reg. \$449, our price, \$389. PRO-62 and PRO-51, Call! DX-390, reg. \$220, call! No tax out of Florida. Call 1-800-848-3004. Orders only. **COTRONICS INC.**, 2250 SE Federal Hwy., Stuart, FL 34994.

WANTED HIGH PERFORMANCE? The "Great" CBs, necessary accessories, antennas of the "Golden Era." Special Schematics, Classic Tubes, Dynamite Xstrs. L.S.A.S.E. to: AC, PO Box 383, Buckner, NY 40010-0383.

R-390 POWER input cables, \$25 shipped. (419) 235-6220.

WANTED: Non-working, Regency HX-1000 scanner for parts. Preferably in good physical condition. Also, working drop-in charger for same. Les Wilson, 104 Rhoda Ave., North Babylon, NY 11703-3212.

MacRadio. Macintosh tutorial program for New Pool Novice & Technician HAM License. \$29.00 + \$3.00 shipping (CA add \$2.40 tax). Lightning Industries, 1806 Milmont Dr., #125, Santa Clara, CA 95035 (408) 942-7998.

THE GE SUPERADIO III with up to four modifications is choice for many DX'ers. Low as \$85. MC, VISA, 800-944-0630.

R-390A SALES-SERVICE PARTS. Info, SASE. Miltronix, PO BOX 80041, Toledo, Ohio 43608.

Low Loss Coax

Aids Scanner Reception

CABLE

Why lose all your antenna gain in a poor grade of coax cable? Our **RF-9913** low-loss 50 ohm cable is the best choice for scanners. Only 3.9 dB at 800 MHz. \$46.50 for 100ft +\$5.95 S&H

1-800-950-WARE

RADIOWARE
PO Box 1478 Westford MA 01886
Write for FREE Catalog!

CIRCLE 76 ON READER SERVICE CARD

C. CRANE COMPANY

COMMUNICATION

Shortwave • Scanners • Antennas
SANGEAN, GRUNDIG, DRAKE, UNIDEN, AOR

The most powerful loop antennas for
Shortwave/MW and much more!

International shipping

558 - 10TH ST. FORTUNA CA 95540

Free Catalog FAX 707-725-9060

800 - 522 - (TUNE) 8863

CIRCLE 54 ON READER SERVICE CARD

SURVEILLANCE & COUNTERSURVEILLANCE Electronic Devices

Hidden Video Cameras • Electronic Kits • Voice Changers
Bug and Phone Tap Detectors • Shotgun Mics • Micro Recorders
• Vehicle Tracking • Locksmithing • AND MORE!

Extra Long Play Telephone Recorders - Silently Tapes \$125.00
Incoming/Outgoing Phone calls automatically... and up

SDY FOR CATALOG SEND \$5.00 TO...P.O. Box 337,
OUTLET Buffalo, NY 14226 (716) 691-3476 - (716) 695-8660

800MHz coverage!

We have scanners with 800MHz coverage!

Brands available include:

ICOM, Kenwood,
Yupiteru, and AOR

ATLANTIC HAM RADIO LTD.

(416) 636-3636

(416) 631-0747 (fax)

All U.S. orders shipped UPS Air

368 Wilson Ave
Downsview, ON
Canada M3H 1S9

212-925-7000

SHORTWAVE RECEIVERS, HAM RADIOS, BOOKS
ANTENNAS, SCANNERS, Business Radios.
**MOTOROLA, ICOM, YAESU, KENWOOD, SONY
GRUNDIG, UNIDEN, ANTENNAS, ETC.**

... our 45th Year ... Worldwide shipping.

Sales ... Service. Large Showroom. Open 7 days.

Barry Electronics Corp.
WORLD WIDE AMATEUR RADIO SINCE 1950
Your one source for all Radio Equipment!

1-800-990-2929

Fax 212-925-7001

540 Broadway, NYC, NY 10012

CIRCLE 53 ON READER SERVICE CARD

FREE SHIPPING!



AOR AR2700 SCANNER

- Coverage of 100 kHz - 1300MHz (no cell)
- AM, NFM, WFM
- 500 Channel Memory
- Illuminated keypad
- Computer Interface Capable

\$398

HOT BUYS!

- UNIDEN BC220XLT SCANNER.....\$239.99
- UNIDEN BCT7 MOBILE SCANNER..\$199.99
- COBRA 148GTL (SSB CB RADIO)..\$159.99
- WILSON 1000 MAG CB ANTENNA...\$69.99
- UNIDEN BC2500 BATTERY PACK....\$14.99
- NATIONAL FREQ. DIRECTORY.....\$9.99



QUIEMENT COMMUNICATIONS

Phone Today 408.998.2355

1000 S. Bascom Ave, San Jose, Ca 95128

CIRCLE 71 ON READER SERVICE CARD

As heard about on WHRI, WINB, WWCR, Radio Copan International

Reviewed by Larry Miller In April '93 "MT"
 Introducing—The New **"TINY TENNA"** Indoor Active Antenna
 The "TINY TENNA" works on LW, MW, SW, VHF & UHF. It runs on a 9 volt battery or AC adapter. (not included) Great for travelers, vacationers, apartment or condo dwellers, etc. No frills, nothing fancy...only pure performance and Made in the USA!
 Complete and easy hook-up for ALL Receivers! Satisfaction Guaranteed!
 Special for "POP COMM" Readers! Only \$19.95*

DWM Enterprises

1709 N. West Avenue, Jackson, MI 49202

*plus \$4 US shipping, \$5 Canada/Mexico, \$6 DX Check or MO only, please US Funds.

CRYSTAL CONTROLLED SURVEILLANCE

VHF & UHF PROFESSIONAL ENCASED PARTIALLY ASSEMBLED TRANSMITTER KITS
 Countersurveillance. Also Tunable 70 to 305 MHz Kits. We Design & Manufacture Our Equipment. Custom Design.

FOR CATALOG SEND \$2.00 TO:

SHEFFIELD ELECTRONICS CO., P.O. Box 377940-S
Chicago, IL 60637-7940, Tel (312) 324-2196

Personal Code Explorer™



Only \$99

- ★ Novices
- ★ SWLs
- ★ Veterans

Receive Digital Signals

Copies MORSE, RTTY, FAX, SITOR, PACKET, and more from your receiver to IBM/PC. Easy hookup. No TNC needed! Easy to use. Extensive manual.

Versatile software/hardware package that copies the greatest variety of coded signals on the air. User friendly menus, digital noise filters, global frequency lists, FAX-GIF converter and more!
 NOW SEE WHAT YOU'VE BEEN MISSING!

Personal Code Explorer - \$99 S&H \$4

Free Brochure. Call-Write-Order. MC/VISA.

Microcraft Corporation

Box 513PC, Thiensville, WI 53092

Phone (414) 241-8144

CIRCLE 66 ON READER SERVICE CARD

CW? NO PROBLEM. You can increase your speed, no matter how many times you've failed before. **Results guaranteed** when you follow the instructions. PASS Publishing's CW Mental-Block Buster program helps you **explode mental blocks** that hold you back. Based on 40 years of research, the **CW Mental-Block Buster** uses guided meditation, dynamic visualizations, and powerful affirmations to blast through mental blocks. You can do code! That means new bands, more contacts, more fun! (This is not a CW practice tape.) The CW Mental-Block Buster audio cassette and practice booklet are only \$29.95 ppd. in the US. GA residents add 6% sales tax. (Quantity discounts available for classes.) PASS Publishing, PO Box 768821, Roswell, GA 30076. 404-640-6295; FAX: 404-640-8780. MC/ VISA, COD. Mail/fax orders include signature. Office hours after 4:30 Eastern.

FOR SALE: Amplifier with four 4-1000A's, Dahl transformers, Jennings vacuum variables monoband 10-12 meters—\$5,000. Grady, POB 62, Cookeville, TN 38503. 615-432-5588.

SCANNER MODIFICATION HANDBOOK VOL.1

by Bill Cheek. The famous original 160-page books. Performance improvement modifications. Simple step-by-step instructions, many photos. Primarily PRO-2004 & PRO-2005, some for PRO-34, BC-200/205XLT, BC-705XLT, BC-705XLT. Restore blocked-out bands, speed up scanning rate, disable "beep," increase number of channels, improve squelch action, add an S-meter, interface with shortwave receivers, etc. Make the PRO-2004 & 2005 into a 6,400 channel scanner; put 3,200 channels into the PRO-34! Plus, cellular frequency charts, antenna info & mods, inside info on frequency management, operating hints, emergency power supplies, scanners & the law, lots more! Only \$18.95, plus \$5.00 s/h (Canada \$6). Residents of NY State add \$2.36 tax. Big 220 page **VOL. 2** with more mods for PRO-2004/5/6, PRO-34, PRO-2022, BC-760/950XL, BC200/205XL, also available, \$18.95 plus \$5.00 s/h (Canada \$6). NY State residents include \$2.36 tax. **NEW!** The Ultimate Scanner, **VOL. 3**. Giant 240-page edition. Many more mods! Picks up where the first two books ended. \$29.95 plus \$5 s/h (Canada \$6), residents of NYS add \$2.97 tax. Order from CRB Research Books, Inc., PO Box 56, Commack, NY 11725. Visa/MC welcome. Tel: 1-800-656-0056.

RADIO MONITORS NEWSLETTER OF MARYLAND FOR THE SERIOUS SHORT-WAVE AND SCANNER LISTENERS. PO BOX 394, Hampstead, MD 21704. For a one year subscription: \$15.00. Sample copy: one dollar.

PRO 23, 34, 37, 39, 43, 46, 51, 2006, 2022, 2026, 2027, 2032, BC-855XLT, BC-200, BC-2500XLT 800 MHz modifications. Well explained and illustrated steps, \$12 each, or \$20 if we do modification. Also modifications for cellular receivers BC80AT, 150, 220, 700, 860, 890, 2500, 3000, 8500, 9000, TR980, 1200, 2400, PRO2035, AR8000, \$7 each. Available to sell your products in Quebec and Canada; new brands and products welcome. A.P., 200 Dineen, Labrador City, Newfoundland, A2V 1E6 Canada.

CB RADIO HACKER'S GUIDE! Big 151 page book; pictorials, diagrams, text. Complete guide to peaking, tweaking, & modifying 200+ CB radios for enhanced performance & more features. Which screws to turn, which wires to cut, AM & SSB radios: Cobra, Courier, GE, Midland, Radio Shack Realistic, SBE, Sears, Uniden/President. Get the most from your CB radio & operations. Only \$19.95, plus \$5.00 shipping (\$6.00 to Canada). NY State residents add \$2.12 tax. Order from CRB Research Books, Inc., PO Box 56, Commack, NY 11725. Visa/MC OK. Tel: (516) 543-9169.

PAN-COM INT'L CATALOG. Over 350 Kits, Plans. Licensed/unlicensed AM/FM broadcasting. Ham/CB/SW/ DX, 1750M transmitters, Surveillance devices, Computers/Software, Science Projects, MORE! \$1 refundable. Box 130-P08, Paradise, CA 95967.

HAM RADIO PROGRAMS (plus 100s of other applications). Low as \$1.00 per disk. Send \$2.00 for catalog and sample disk to: TRI-MI SOFTWARE, 517 Pine Brook Road, Eatontown, NJ 07724. (908) 389-1049.

MEN OF ACTION AND ADVENTURE

Paladin Press has been described as "the most dangerous press in America." Millions of satisfied readers disagree. Outrageous and controversial books and videos on firearms, exotic weaponry, unconventional warfare, new identity, espionage and investigation, privacy, action careers and more! To order our 50-page catalog send \$1.00 to: Paladin Press, Box 1307-3BP, Boulder, CO 80306. (303) 443-7250.

WOW! UNDERSTANDING & REPAIRING CB RADIOS

by Lou Franklin. **Giant 380-page technical book picks up where THE "SCREWDRIVER EXPERTS" GUIDE leaves off.** Includes circuit descriptions and troubleshooting guide for virtually all CB radios: **23 and 40-channel, crystal and PLL, solid-state and tube, AM, FM, SSB, CW, American, British and export models.** Covers test equipment, transistor basics, synthesizers, receivers, transmitters, power supplies, T/R switching, antennas, interference, parts and accessory sources. **Over 350 illustrations, plus huge subject index. Moneyback Guarantee! Only \$29.95, plus \$3.50 U.S. & Canadian Air Mail, VISA/MC accepted. Free catalog of unique CB books, plans, and modification kits with order. Catalog only \$3. CBC INTERNATIONAL INC., BOX 31500PC, Phoenix, AZ 85046. Thousands of satisfied customers since 1976.**

LAST CHANCE: We have a very limited supply of the modifiable cellular Bearcat scanners left, BC-200XLT, BC-2500XLT, BC-890XLT, etc. Once these are gone, they are gone forever. Call for close-out prices—we ship COD, and free U.P.S. shipping to 48 states. Galaxy, Box 1202, Akron, OH 44309, (216) 376-2402, 8:30-4:30 EST. Our 11th year!

LOCATING, TRANSLATING SERVICE:

Books, shop service manuals, journals. Will barter third world translation services, book forwarding. Waterproof pages optional. Specialties: Bio-medical, folk medicine, Celestial Navigation. \$200 package. Bater with bible translators, Peace Corps, others. R.V. Engineering, PO BOX 734, Ottertail, MN 56571. (218) 367-2636.

ANTENNAS for CB, SCANNER, CELLULAR,

2-WAY base, portable, mobile. High quality at discount prices. Price list, \$1. **Radio Communications Services**, 1007 Eastfield, Lansing, MI 48917.

GUIDE TO THE AR1000.

We publish a complete, 90-page guide for the operation and use of all AOR-AR1000 and Fairmate HP-100/200 scanners. Comes with 10 scan bank templates and a handy, six-panel, folded Quick Reference Card. \$18.45 including S&H in the USA. Design EQ, PO Box 1245-PC, Menlo Park, CA 94025. 415-328-9181.

NATIONAL SCANNING REPORT,

America's #1 all-scanning magazine. Articles, frequencies, new products, more. One year subscription (\$19.90) includes custom frequency print-out for your county. Order toll-free 1-800-423-1331. Sample copies \$3.00 cash from Box 360, Wagontown, PA 19376.

**ORGANIZE AND
PROTECT YOUR
COPIES OF**

POPULAR COMMUNICATIONS

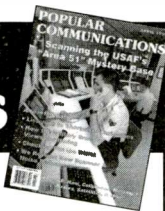

Now there's an easy way to organize and keep copies of your favorite magazine readily available for future reference.

These custom-made titled cases and binders are ideal to protect your valuable copies from damage.

They're designed to hold a year's issues (may vary with issue sizes), constructed with reinforced board and covered with durable leather-like material in flat blue, title is hot-stamped in gold, cases are V-notched for easy access, binders have special spring mechanism to hold individual rods which easily snap in.

Add \$1.50 S & H (\$3.50 outside the US) per case or binder.

Cases: 1-\$8.95 2-\$24.95 6-\$45.95 Binders: 1-\$11.25 2-\$31.85 6-\$60.75

Mail all correspondence to:
Popular Communications

**Jesse Jones Industries, Dept. 95 PC
499 East Erie Avenue, Philadelphia, PA 19134**

CHARGE ORDERS: (Minimum \$15): AMEX, VISA, MC, DC accepted. Send card name, #, Exp. date.

Allow 4 to 6 weeks delivery

Call TOLL FREE 7 days, 24 hours 1-800-825-6690

The World Scanner Report



publishes 10/yr for
casual & expert
radioists who are



E-Mail: bcheek@cts.com
CompuServe: 74307.3376

BBS/FAX: (619) 578-9347
Voice only 1:30pm-5:30pm, PST

committed to

excellence in the pursuit of VHF-UHF scanning • Edited and published by Bill Cheek, author of *The Ultimate Scanner* and the *Scanner Modification Handbooks* • SASE or 2 IRC for info

US Funds: \$5/ea; \$35/yr; Canada & all foreign surface +25%; MC/VISA ok

COMMtronics Engineering Box 262478 San Diego, CA 92196

CIRCLE 55 ON READER SERVICE CARD

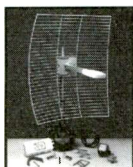

Quality Microwave TV Systems
WIRELESS CABLE - ITFS - MMDS
ATV - INTERNATIONAL - S-BAND
Amplifiers • Antennas • Books • Components
Filters • Systems • Video Products
• RF Frequency 1990 - 2700 MHz
• Cable Ready - VHF - UHF Outputs
• SASE For "FREE" Catalog or Send \$1

PHILLIPS-TECH ELECTRONICS
PO Box 8533 • Scottsdale, AZ 85252

ORDER LINE 800-880-MMDS
CATALOG/INFO 602-947-7700
FAX LINE 602-947-7799
Visa • MC • Amx • Disc • COD's • Qty Pricing

CHALLENGER SYSTEM
33-Channel 52dB Gain
Complete Grid 5265
Five Year Warranty
FREE SHIPPING

CIRCLE 69 ON READER SERVICE CARD



Get online
with
**Pop Comm
on GEnie®**

Look for us in the *Radio &
Electronics Roundtable*

To join GEnie, use your computer &
modem to call 1-800-638-8369.

At the **U#** prompt, type **JOINGENIE**

And for a special introductory offer,
At the **key/offer code** prompt,
type **BWH528**

CIRCLE 62 ON READER SERVICE CARD

86 / POPULAR COMMUNICATIONS / September 1995

BUILD THE ULTIMATE 11 meter vertical. For detailed plans send \$15 to Terrapin Sales, P.O. Box 12426, La Crescenta, CA 91224-5426.

SATELLITE RADIO BOOK AND GUIDE. New book covers all Audio Services, SCPC, Subcarriers, FM Squared, Facsimile, Press Services, Weather Services. Simple how-to-receive instructions, \$16.95, plus \$3 Priority Mail. UNIVERSAL ELECTRONICS, 4555 Groves Road, #12, Columbus, OH 43232, or call (614) 866-4605.

UHF MILITARY BAND (225 to 400 MHz) monitoring aids. High performance MAX-225 ground plane antenna designed especially for this band, fully assembled, \$29.95 plus shipping. GRE Super Amplifier 20 dB scanner preamp (100 to 1000 MHz), \$55.95 plus shipping. "Directory of North American Military Aviation Communications," your state or province, \$24.95 plus shipping. "Top Secret Registry," \$21.95 plus shipping. USA shipping is \$5 for first item, and \$1 for each additional item. Canadian shipping \$6 for first item, and \$2 for each additional. NY State residents add 8.5% sales tax to item price and shipping cost. MC/VISA welcome. CRB Research, P.O. Box 6, Commack, NY 11725. Phone orders: 1-800-656-0056, Canada/AK/HI phone orders: (516) 543-9169.

NTR-1 DSP NOISE/TONE REMOVER, new. I paid \$169.95; yours for only \$95. Send money order to Yassin Abdela, Two Riverside Street, Rochester, NY 14613. Call (716) 254-0940 before mailing check.

MILITARY RADIOS: Easily made battery adapters for military radios & other electronics. Get **POWER UP!** Big new 96-page manual of instructions, diagrams. Use readily available commercial batteries in PRC-6, -8, -9, -10, -25, -28, -47, -74, -77, TRC-77, AN/PRC-9, AN/PRT-4, RT-77, URC-68, more; also mine detectors, night scopes, radiacs, field telephones, etc. Only \$14.95, plus \$5 s/h (\$6 Canada). NYS residents add \$1.53 tax. CRB Research Books, Box 56-PC, Commack, NY 11725. VISA/MC accepted. Phone (516) 543-9169.

THE AMERICAN INTERNATIONAL CLUB is the fastest growing 27 MHz LSB DX club in existence. For application send SASE: AIC, Box 701431, Queens, NY 11370.

MINIATURE TRANSMITTERS! All types! Send \$2 for information, refundable on first purchase. Parsec Electronics, P.O. Box 34594, Phoenix, AZ 85067-4594.

"FORBIDDEN SECRETS OF THE LEGION OF DOOM HACKERS!" Big 224-page handbook. The infamous LOD's condemned programs and amazing techniques, from the LOD's now shut down in BBS. Hacking, phreaking, and more! Hard to locate information, now in this limited edition. For reference and informational purposes only, \$20.95, plus \$5 s/h (Canada \$6). NYS add \$2.21 tax. VISA/MC okay. CRB Research Books Inc., Commack, NY 11725. Phone orders: 1-800-656-0056.

FREE IMPORT/EXPORT CB CATALOG by **FAX-ON-DEMAND** 24 hours a day. **LOWEST PRICES.** Call **LORD/WYATT COMMUNICATIONS**, (718) 789-7329.

RESTRICTED top secret Hacker information. Cellular/cable/surveillance/satellite/VideoCipher/books/videos and more. Catalog—\$3. **TELECODE**, P.O. Box 6426-PC, Yuma, AZ 85366-6426.

PROBE. Powerful! Easy! Fast! Ultimate software for Optoelectronic's **OptoScan 456**. Free details. **DataFile Inc.**, Box 20111, St. Louis, MO 63123.

ICW Lite is the **easiest** Morse Code training method in the world, bar none! And it is the fastest, too. Just closed your eyes and relax. This powerful **hypnosis cassette tape** does the rest. Subliminals speed you along! Only \$15.95 ppd in US (GA residents add 6% tax). Order today! **PASS Publishing**, Box 768821, Roswell, GA 30076. 404-640-6295; FAX: 404-640-8780. Office hours after 4:30 PM Eastern. MC/VISA, COD. Mail/fax orders include signature.

PIRATE RADIO, TIS, or emergency MW antennas. Ten-foot fiberglass, \$184 plus shipping. **HELIX-ING**, 1302 McCameron, Lockport, IL 60441, (815) 836-0426.

MORSE CODE Got You Down? Why let a mental block stand between you and upgrading? Use **PASS Publishing's CW Mental-Block Buster** to blast through those barriers. Just follow the instructions for 30 days—Results Guaranteed! Based on 40 years of research, the **CW Mental-Block Buster** uses guided meditation, dynamic visualizations, and powerful affirmations to blast through mental blocks. **You can do code!** That means new bands, more contacts, more fun! (This is not a CW practice tape.) The **CW Mental-Block Buster** audio cassette and practice booklet are only \$25.95 ppd. in the US (GA residents add 6% sales tax). (Quantity discounts available for classes.) **PASS Publishing**, PO Box 768821, Roswell, GA 30076. 404-640-6295; FAX: 404-640-8780. Office hours after 4:30 PM Eastern. MC/VISA, COD. Mail/fax orders include signature.

HALLICRAFTERS CONTINENTAL MODEL 5R33A manual wanted. Will pay postage and copying. Steve Batson, 4012 Staunton Ave., Charleston, WV 25304. **SELECTED SHAREWARE** (MSDOS): Choice programs. All good. Many unusual. No disappointments. \$1 each. Free catalog on disk. Restricted book listing included. **MENTOR PUBLICATIONS, Box 1549-P, Asbury Park, NJ 07712.**

'M INTERESTED in exchanging frequencies with scanner listeners in the Buffalo, Western New York area, and Toronto Southern Ontario area. Joe Galante, 34 Hampton Court, Williamsville, NY 14221-4301.

THE MONITORING MAGAZINE



NRD-535D

"Best Communications Receiver"

World Radio TV Handbook 1992



"Unsurpassed DX Performance"

Passport to World Band Radio 1992

Setting the industry standard once again for shortwave receivers, the NRD-535D is the most advanced HF communications receiver ever designed for the serious DXer and shortwave listener. Its unparalleled performance in all modes makes it the ultimate receiver for diversified monitoring applications.

Designed for DXers by DXers! The NRD-535D (shown above with optional NVA-319 speaker) strikes the perfect balance between form and function with its professional-grade design and critically acclaimed ergonomics. The NRD-535D is the recipient of the prestigious World Radio TV Handbook Industry Award for "Best Communications Receiver."

JRC *Japan Radio Co., Ltd.*

Japan Radio Company, Ltd., New York Branch Office - 430 Park Avenue (2nd Floor), New York, NY 10022, USA Tel: (212) 355-1180 / Fax: (212) 319-5227

Japan Radio Company, Ltd. - Akasaka Twin Tower (Main), 17-22, Akasaka 2-chome, Minato-ku, Tokyo 107, JAPAN Tel: (03) 3584-8836 / Fax: (03) 3584-8878

- Phase-lock ECSS system for selectable-sideband AM reception.
- Maximum IF bandwidth flexibility! The Variable Bandwidth Control (BWC) adjusts the wide and intermediate IF filter bandwidths from 5.5 to 2.0 kHz and 2.0 to 0.5 kHz—continuously.
- Stock fixed-width IF filters include a 5.5 kHz (wide), a 2.0 kHz (intermediate), and a 1.0 kHz (narrow). Optional JRC filters include 2.4 kHz, 300 Hz, and 500 Hz crystal type.
- All mode 100 kHz - 30 MHz coverage. Tuning accuracy to 1 Hz, using JRC's advanced Direct Digital Synthesis (DDS) PLL system and a high-precision magnetic rotary encoder. The tuning is so smooth you will swear it's analog! An optional high-stability crystal oscillator kit is also available for ± 0.5 ppm stability.
- A superior front-end variable double tuning circuit is continuously controlled by the CPU to vary with the receive frequency automatically. The result: Outstanding 106 dB Dynamic Range and +20 dBm Third-Order Intercept Point.
- Memory capacity of 200 channels, each storing frequency, mode, filter, AGC and ATT settings. Scan and sweep functions built in. All memory channels are tunable, making "MEM to VFO" switching unnecessary.
- A state-of-the-art RS-232C computer interface is built into every NRD-535D receiver.
- Fully modular design, featuring plug-in circuit boards and high-quality surface-mount components. No other manufacturer can offer such professional-quality design and construction at so affordable a price.

Advertisers' Index

AMC Sales, Inc.	49
AOR, LTD.	Cov II
ARRL.....	33,75
Ace Communications.....	Cov III
Alpha Delta Communications	51
Antenna Supermarket.....	61
Antique Radio Classified.....	29
Atlantic Ham Radio.....	83
Barry Electronics.....	83
Bearcat Radio Club.....	37
C. Crane Company.....	83
CB City International, Inc.....	68
CRB Research.....	10,54
CQ Beginner's Guide to Amateur Radio.....	82
CQ Books & Videos.....	58,59
Cellular Security Group.....	31
Chilton Pacific Limited.....	32
COMMtronics Engineering.....	86
Communications Electronics, Inc.....	19
Computer Aided Technologies.....	21,27,31
Copper Electronics.....	65
DECO.....	28
DWM Enterprises, Inc.....	84
DataFile, Inc.....	10
Delta Research.....	24
Drake, R.L. Company.....	15
EDCO.....	7,35,37,39,54,78
Electronic Equipment Bank.....	1
G & G Electronics.....	80
GMRS Radio Sales.....	28
GENIE Radio & Electronics RoundTable.....	86
Gilfer Shortwave.....	6
Grove Enterprises.....	24
ICOM America, Inc.....	45,Cov IV
Index Publishing Group, Inc.....	76
Intensitronics Corp.....	41
JPS Communications, Inc.....	27
Japan Radio Co., Ltd.....	87
Jesse Jones Industries.....	86
Jo Gunn Enterprises.....	57
K & L Technology.....	21
Lentini Communications, Inc.....	78
MFJ Enterprises, Inc.....	43
Microcraft.....	84
MoTron Electronics.....	67
Mouser Electronics.....	67
Optoelectronics, Inc.....	4,23,85
Philips-Tech Electronics.....	86
Precision Electronics Publications.....	60
Quement Communications.....	84
R.C. Distributing.....	29,60
REACT International.....	74
Radio Bookstore.....	80
Radio Shack.....	25
Radioware.....	83
SGC, Inc.....	10
Scanner World USA.....	53
Scrambling News.....	68
Sheffield Electronics Co.....	84
Signal Intelligence.....	49
Software Systems Consulting.....	39
Spectrum International, Inc.....	9
Sports Communications Dist.....	32
Spy Outlet.....	83
Timestep.....	9
Tucker Electronics.....	13,16
U.S. Scanner Publications.....	47
USRadio.....	57
Universal Radio, Inc.....	3,81
Viking International.....	68
Virginia Beach Hamfest & Computer Fair.....	20
Wilson Antenna, Inc.....	29
Xandi Electronics.....	60
Yaesu U.S.A.....	73

Reach this dynamic audience with your advertising message, contact Don Allen, N9ALK at 217-344-8653, FAX 217-344-8656

WANTED: Service manual for Realistic DX-300 S.W. receiver with schematics. Please write: Dwight Kornelsen, VE5 DXK, Box 1311, Watrous, Saskatchewan, SOK 4T0 Canada.

MILITARY MONITORING GUIDE. New book covers all phases of Military Monitoring. Military Frequencies all services: U.S. Military Bases, Military Black Projects, Major Air Force Installations, Monitoring Equipment and Systems, Navy/Coast Guard, and more, \$19.95, plus \$4 Priority Mail. UNIVERSAL ELECTRONICS, 4555 Groves Road, #12, Columbus, OH 43232. (614) 866-4605.

INTERNATIONAL CLASSIFIED ADS. Buy sell or trade electronic "stuff." Biweekly publication. Free ads, send today! Trading CIRC-IT, 86 Victoria Street, South Kitchener Ontario Canada N2G 2A9. SASE for information. E-mail b.blyleven@genie.geis.com.

COMPUTER \$\$\$! Start a home computer business or enhance any business with computer business needs. Startup/operation manuals, video tapes, business software, turn-key computer systems. FREE brochure. The Harsin Company, 8681-B West, New Bethel Road, Lexington, IN 47138. (812) 866-4076. (24-hours).

SECRET CB BOOKS I-29, \$10 each. Sams books \$15 each. Modulation kits RCI 2950, HR 2510, Connex 3300, Cobra 148, Cobra 29, plus many more, \$17. Call 1-800-536-0109 for free catalog.

HOME AUTOMATION. Become a dealer in this fast-growing field. Free information. Send name, address, phone to ECS, Box 407, Fairbury, NE 68352, or call (800) 838-4051.

KENWOOD R-5000 with YK-88A-1, YK-88SN, IF232C, IC-10 and software \$750. PRO-2006, \$300. All like new, in box(es). Bob Randall (402) 483-2429.

FM BROADCASTING: Transmit many miles, excellent sound, 80-108 MHz. Not a bug. Kit or assembled, full info call 24 hours. R. Scott Communications, (604) 642-2859.

VHF AERO SCANNER GUIDE: Kneitel's Air-Scan, sixth edition. Great new edition of the new comprehensive and popular USA/Canada VHF aero band directory ever published: Civilian, Military, Private Airports, Heliports & Seaplane Bases. Control Towers, ARTCC, Weather, Approach/Departure, FSS, Ground Control, ATIS, Unicom, National & Air National Guard freqs., etc. Many listings for airport security, fire/rescue, airline ground services & more beyond the aero band. You ONE "must have" guide to tens of thousands of aero related monitor frequencies! Only \$18.95, plus \$5 s/h (\$6 to Canada) from CRB Research, P.O. Box 56, Commack, NY 11725. VISA/MC accepted. Phone orders 1-800-656-0056. Orders from Canada/HI/AK: (516) 543-9169. (NYS res. add \$2.04 tax.)

SCANNING RECEIVERS for monitoring police, fire, aircraft. Base, mobile, handheld. Antennas, CBs, and accessories. HPR Box 621136C, Littleton, CO 80162.

LOOKING for owner's manual for Panasonic model RF-4900. Scott Douglas, 513 North Franklin Street, Juneau, AL 99801.

DISCOVER ANSWERS to the 15 most asked questions about the inner workings of the **TELEPHONE INDUSTRY.** Call now 1-900-656-8818, \$2 per minute, adults over 18 only. For a list of the 15 questions call Clark's Creative Computing at 1-619-320-8793.

CABLE DOCTOR—Stop the bullet and ID signaling cable lines. Send \$21 to RR Enterprises, Department PC, Box 3532, Easton, PA 18043.

FREE Buy/Sell listing searches. FREE two month listing. Used/Surplus/Antique Equipment/Parts/Books. **Communications/Computer/Electronics Exchange BBS,** Modem: (201) 993-0811 (8/N/1/ANSI) or Suite 111, 103 Washington, Morristown, NJ 07960.

DISCOUNT BOOKS AND SOFTWARE. Free brochure! Write to: Ratek, Box 2098, Danbury, CT 06813-2098. Catalog on disk, \$2.

RCI-2950/2970 MODIFICATION MANUAL. Power and modulation increase. Clarifier, receiver, noise blanker modifications, operating hints, and more. Parts included, \$20 ppd U.S. money order, \$25 COD (MO residents add \$1.15 tax). Scott, P.O. Box 510408, St. Louis, MO 63151-0408, (314) 846-0252.

SCANNER FREQUENCY SEARCHES: Hear it all!! New services. SAE to: Heald, 6886P Jefferson, North Branch MI 48461.

CABLE TV DESCRAMBLERS/CONVERTERS. Why rent? Lower your bill. SAVE \$. Wholesale prices. Money back guarantee. Free 30-day trial. **RP ELECTRONICS,** 1-800-304-3604.

JUST PUBLISHED, Bill Cheek's The Ultimate Scanner (Cheek 3) doesn't just build on his two earlier bestsellers. His new, indispensable bench manual goes further and faster, detailing scanner modification technology including memory enhancements, up to 25,600 channels, cellular restoration, simple ways automate arduous scanning tasks, signal discrimination, computer interfaces, optimum antennas, autologging "hits," power options, SCA decoders, autorejecting, hacking, and tons more. With a wealth of step-by-step procedures, photos, charts, diagrams, and schematics, Cheek shows us how to dramatically improve scanner performance. 250 pages, large format, \$29.95 (plus \$4 s/h; CA add 7.75% tax). Index Publishing Group, Inc., 3368 Governor Drive, Suite 273P, San Diego, CA 92122; order line, (800) 546-6707.

VHF SCANNER INTERMOD—Our notch filter eliminates the pagers in the 152-153 MHz region that are responsible for 99% of intermod. No need for +12. See January 1995 CQ review of the ham version. Ruggedly built in solid brass. Fixed station version VHF DN153 w/UHF conn. \$62 BNC +\$8. Handheld version with M/F BNC VHF DN153HT \$68. \$4s/h. We also ship C.O.D. No charge. Par Electronics, (407) 586-8278, FAX (407) 582-1234. 6869 Bayshore Drive, Lantana, FL 33462.

WANTED: Squires-Sanders SS1B's, SS1R1, SS1R, SS1V. Weber, 4845 West 107 Street, Oak Lawn, IL 60453-5352.

WANTED: Buy non-working Realistic scanners for parts, PRO-34, PRO-36, PRO-37, PRO-39, PRO-43, PRO-62. Francis Fong, 3322 Ala Lehua Place, Honolulu, HI 96818.

AR8000/PRO-43 Bound Frequency Assignment Logs. 5 1/2x8. Specify which booklet. 1/\$7.50, 2/\$12. Custom quotes. To: A. Wilde, P.O. Box 708, West Acton, MA 01720.

WANTED: Realistic DX-160 five band receiver or Realistic DX-300. Pay cash! Call anytime. Larry, (409) 299-1897.

\$100 (+\$200 EXPENSES) to improve my short-wave reception (can't get WWV on Kenwood R-1000, etc.). Come to my home in Central New Jersey, diagnose, and fix problems. Roy, (908) 246-0737.

SHACK CLEAN OUT! Equipment, books, magazines, club bulletins, tapes, station momentos, miscellany. Full list for an SASW w/two units of postage. G. Dexter, 213 Forest Street, Lake Geneva, WI 53147.



Grundig
YB400
\$199



Sangean
ATS818
\$145



Bearcat BC890XL
29-958MHz
\$249



Bearcat
BC3000
25-
1300MHz
\$379



Bearcat
BC220
Twin
Turbo
\$229



Bearcat BC9000XL
25-1300MHz \$379



Police FireAction
Videos \$24.95

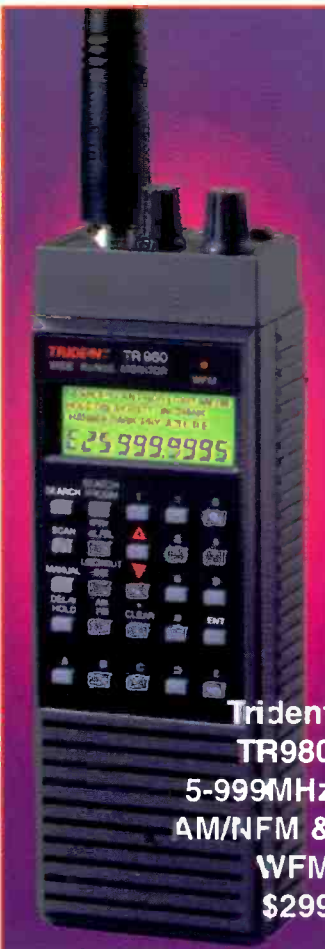

Trident
TR980
5-999MHz
AM/NFM &
WFM
\$299



Trident
TR1200
.5-1300MHz
AM/NFM/WFM
1000 Channels
\$399

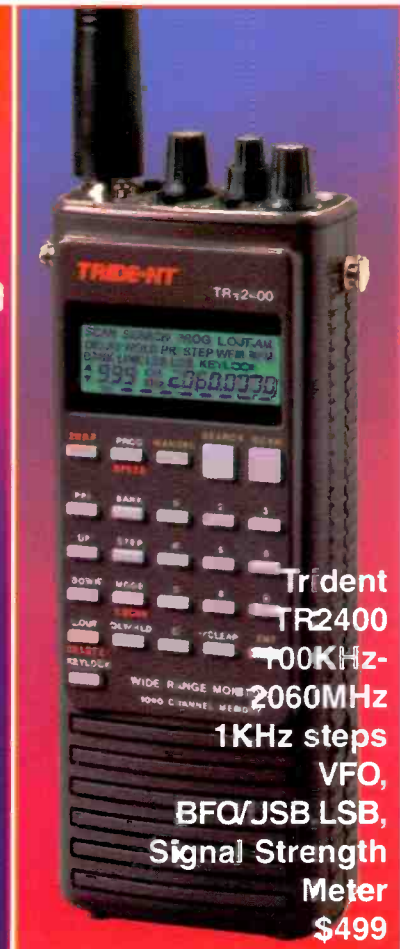

Trident
TR2400
100KHz-
2060MHz
1KHz steps
VFO,
BFO/JSB LSB,
Signal Strength
Meter
\$499

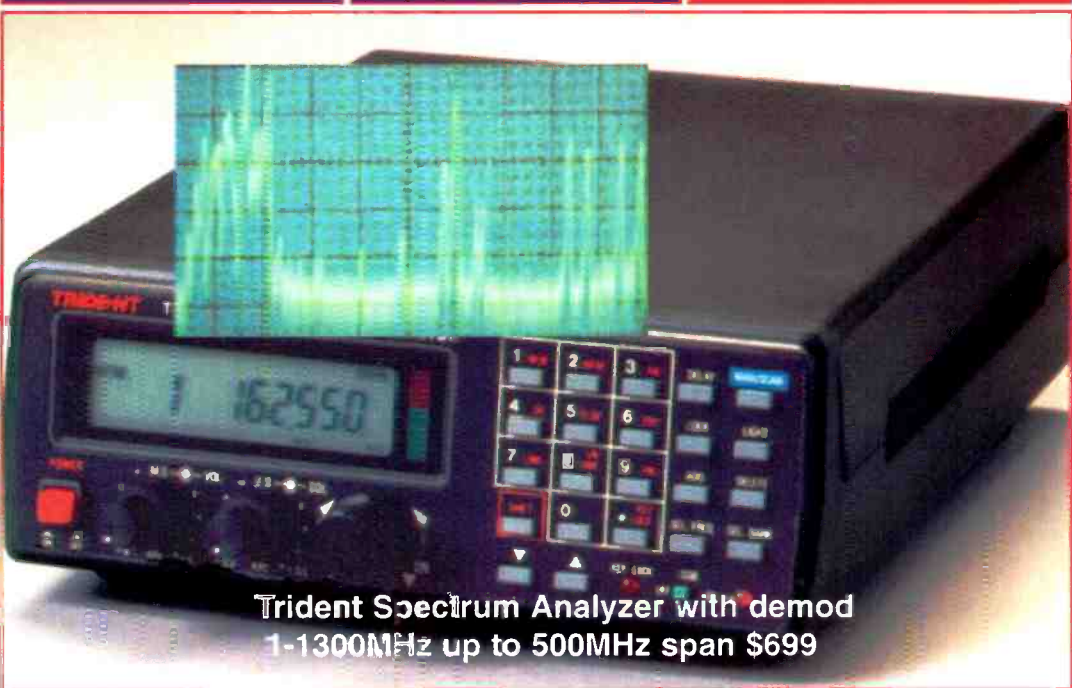

Trident Spectrum Analyzer with demo
1-1300MHz up to 500MHz span \$699

Tech Support 317-845-7436

1 800 445 7717

Faxback Service 317-849-8683

Fax 317-849-8794

10707 East 106th Street Fishers, IN 46038
E Mail: ACESCAN@aol.com

Computer BBS 317-579-2045

Call about these and a host of other radio receivers and accessories from anywhere in the world, 24 hours a day, 7 days a week. For computer users, our BBS offers free product and frequency information, or use our faxback service for instant specs and info. So call us now, we'll give you the benefit of our over 20 years experience with radio receivers. Mastercard, Visa, AMEX, Discover, Government & Corporate P.O.'s. plus COD. Price/specs/availability subject to change. Free trial period on all units. All units carry full factory warranty. IN residents add Tax. Flat rate ground shipping, \$6.95. Air Freight for as little as \$10.95 per unit for most locations. All trademarks property of their respective owners. Products are made or licensed under a variety of patents, write for details. Call to confirm price and delivery before ordering.



CIRCLE 15 ON READER SERVICE CARD

ICOM BASE STATIONS

IC-275H



- Dimensions: 9.5 (W), 3.7 (H), 9.4 (D), 13.2 lb
- 100 W
- 144 MHz
- 99 Memory Channels
- Direct Digital Synthesis
- Lockup Times < 5 msec.
- Data Switch
- Built-in Preamplifier (10 db)
- High Stability
- Fast Squelch Circuit
- Passband Tuning
- Notch Filter
- Variable Tone Control
- Speech Compressor

IC-475H



- Dimensions: 9.5 (W), 3.7 (H), 9.4 (D), 13.2 lb
- 75 W
- 440 MHz
- 99 Memory Channels
- Direct Digital Synthesis
- Lockup Times < 5 msec.
- Data Switch
- Built-in Preamplifier (10 db)
- Fast Squelch Circuit
- High Stability
- Passband Tuning
- Notch Filter
- Variable Tone Control
- Speech Compressor

IC-575H



- Dimensions: 9.5 (W), 3.7 (H), 9.4 (D), 13.4 lb
- 100 W
- 28 MHz (10 M)/ 50 MHz (6 M)
- 99 Memory Channels
- Direct Digital Synthesis
- Lockup Times < 5 msec.
- Data Switch
- Built-in Preamplifier (10 db)
- Fast Squelch Circuit
- High Stability
- Passband Tuning
- Notch Filter
- Variable Tone Control
- Speech Compressor

IC-970H



- Dimensions: 16.7 (W), 5.9 (H), 16.0 (D), 32.0 lb
- Multi Band, All Mode
- 144 MHz/ 440 MHz Built-in
- 1.2 GHz/ 2.4 GHz/ 50-905 MHz Rx Opt.
- 396 Memories
- 45 W (2 M), 40W (440 MHz), (10W (1.2 GHz) Optional)
- Automatic Satellite Tracking
- 10 Satellite Memories
- Simultaneous Receive
- Built-in Power Supply

IC-820H



- Dimensions: 9.5 (W), 3.7 (H), 9.4 (D), 11.0 lb
- Dual Band, All Mode
- 45 W (2 M), 40 W (440 MHz)
- 1 Hz Tuning Resolution
- 116 Memories (10 Satellite)
- Built-in Satellite Functions
- Independent Controls and Display
- Sub Tuning Functions
- 9600 BPS Packet Operation



Call the Brochure Hotline: (206) 450-6088 or contact ICOM Technical Support in the HamNet Forum on CompuServe® @ 75540,525 (Internet: 75540.525 @ compuserve.com) for more information about these products.

© 1995 ICOM America, Inc. AM-2944 6-95. The ICOM logo is a registered trademark of ICOM, Inc.

ICOM®